



Pullbloc® 3.0 Sortiment
Preise gültig ab 01.07.2021

scoop®, Pullbloc®, Pullbloc® 3.0, Pullbloc® 4.1, Slidebloc®, Slidebloc® 3.0, Slidebloc® 4.0, Slidebloc® light und formspiele® sind eingetragene Marken der scoop Beschläge Vertriebs-GmbH. Die in diesem Katalog enthaltenen Beschreibungen und Abbildungen entsprechen dem Zeitpunkt der Drucklegung. Für Druck- oder Satzfehler wird keine Haftung übernommen. Unsere Allgemeinen Geschäftsbedingungen finden Sie unter www.scoop-tec.de. Alle Rechte behalten wir uns vor.
© copyright: scoop Beschläge Vertriebs-GmbH. Mai 2021.

Inhalt

Einleitung	ab	2
Kombinationsmöglichkeiten	ab	18
Schnellübersicht Formen	ab	20
Privat- und Objektbau GK3	ab	27
Feuerschutzgarnituren	ab	197
Rosetten/Knöpfe/Schilder	ab	211
Office Glastürbeschläge	ab	247
Glastürbeschläge	ab	253
Fenstergriffe	ab	277
Sicherheit	ab	311
Stoßgriffe	ab	331
Muschelgriffe	ab	342
Türstopper	ab	347
Türfixierer	ab	349
Hausnummern	ab	350
Buchstaben und Hinweisschilder	ab	351

Beste Qualität, bester Preis auch für den Privatbereich.

Made in Germany

Alle funktionsrelevanten Bauteile – die Kugellagertechnik **Pullbloc®** wie auch die Gleitlagertechnik **Slidebloc®** – werden an unserem Produktionsstandort in Fridolfing (Bayern) entwickelt und produziert. Dies ermöglicht uns eine lückenlose Qualitätskontrolle bei allen Komponenten und nach jedem einzelnen Produktionsvorgang. Achten Sie immer auf das Original!

Edelstahlteile

Sichtteile aus Edelstahl wie Drückerhandhaben, Deckrosetten oder dergleichen werden je nach Angebot weltweit in entsprechenden Produktionsstätten gefertigt. Die Vor-Ort-Qualitätskontrolle sichert unsere hohen technischen wie auch optischen Qualitätsansprüche.

Das Material

Die EDELSTAHL-Legierung „304“ ist besonders korrosionsbeständig und widerstandsfähig. Die Oberfläche hält härtester Beanspruchung stand. Aufgrund dieser Eigenschaften ist EDELSTAHL 304 ein idealer Werkstoff für Baubeschläge. Achten Sie bei EDELSTAHL-Produkten immer auf die Güteklasse! (Angaben nach AISI-Normen)



Best quality, best price also for the private domain.

Made in Germany

All functionally relevant components – the ball bearing technology **Pullbloc**[®] as well as the slide bearing technology **Slidebloc**[®] – are developed and produced at our production site in Fridolfing (Bavaria). This permits us to conduct a complete quality control for all components and after each individual production process. Always look for the original!

Stainless steel parts

Visible parts made of stainless steel, like handles, cover plates and such, are produced globally according to offer in the respective production sites. The on-site quality control ensures our high technical and optical quality requirements.

The material

The “304” stainless steel alloy is particularly corrosion-proof and durable. The surface withstands even the hardest strains. Due to these characteristics, stainless steel 304 is an ideal material for building fittings. Always pay attention to the quality grade of stainless steel products!
(information according to AISI standards)

Dauerhaft schön ist nur was dauerhaft funktioniert!

Jeden Tag, zu jeder Stunde, überall ...

Türgriffe sind so selbstverständlich, wir bemerken und sehen sie nicht mehr, obwohl wir sie jeden Tag, zu jeder Stunde überall auf unserer Welt unzählige Male betätigen. Erst, wenn sie nicht mehr funktionieren, fallen sie uns auf. Demzufolge ist die vorrangige Aufgabe eines Türgriffs, so lange wie nur möglich unbemerkt und unbeachtet zu bleiben. Für uns Grund genug Bewegungsmechanismen für unsere Garnituren zu finden, die genau diese Kriterien erfüllen.

Pullbloc®, **Slidebloc®** und **Slidebloc® light** arbeiten auch bei überdurchschnittlicher Beanspruchung verlässlich, lautlos, unbemerkt und dauerhaft.

Über Farbe, Form und Material sollte man nachdenken,

über dauerhafte Funktionsqualität niemals. Wer darauf wert legt, dass seine Türgriffe trotz optimaler und dauerhafter Funktion bemerkt und beachtet werden, sucht sich eine entsprechende Form auf den folgenden Seiten aus.



Permanent beauty implies permanent performance!

Every day, every hour, everywhere ...

Door handles are such a matter of course, we don't even notice and see them anymore although we use them every day, every hour, everywhere around the world countless times. Only when they don't work we become aware of them. Thus it is the chief task of a door handle to remain unnoticed and disregarded for as long as possible. Reason enough for us to find movement mechanisms for our handle sets which meet exactly these criteria.

Pullbloc®, **Slidebloc®** and **Slidebloc® light** work in a reliable, noiseless, unnoticed and permanent way even in case of strain above average.

We should consider colour, shape and material,

but never permanent functional quality. Those who put emphasize on the fact that their door handles are noticed and regarded despite an optimal and permanent function pick out the respective shape on the following pages.

Mehrwert ohne Mehrpreis! Sprechen Sie mit Ihrem Fachberater.

Keine Schneckenfeder, keine Flachfeder!

Diese sind nahezu in allen Türdrückergarnituren verbaut. Es ist kaum zu vermeiden, dass sich durch die Drehbewegung einzelne Windungen berühren und dabei aneinander reiben. Dies kann schon, nach nur wenigen Betätigungen, zu unerwünschten Kratzgeräuschen führen.



Kein dünner Kunststoffring als Drückerlagerung

zwischen Metallrosette und Drückerhandhabe!
Der markanteste Schwachpunkt marktüblicher Gleitlagern. Sie weisen Wandstärken von meist nur 0,5 mm auf und können sich schon nach nur kurzer Zeit durch die Reibung des Drückeransatzes durchscheuern. Die Folge kennt jeder, eine wackelige axiale Lagerung, welche die Funktion erheblich beeinträchtigt.

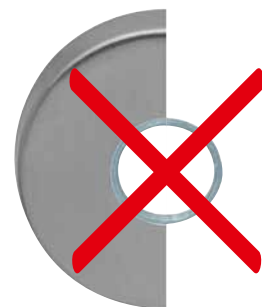



Die Pullbloc®-Kugellagertechnik! Die neueste Generation der Drückerlagerung mit Rückstellung.

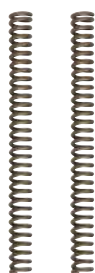

Druckfedern

aus hochwertigem Federstahl in Deutschland hergestellt! Laufruhig und gleichmäßig bringen sie dauerhaft den Drücker immer und immer wieder in die gewünschte Ursprungsposition.

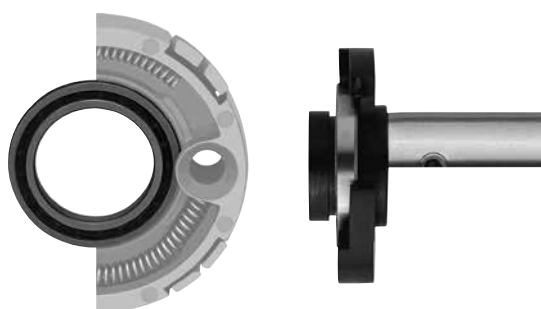

Original Pullbloc®-Kugellagertechnik!

Das Kugellager aus gehärtetem Stahl wurde genau für diese spezifischen Beanspruchungen erdacht und entwickelt. Dieses gewährleistet eine reibungsarme, lautlose Drehbewegung. Achten Sie immer auf die original **Pullbloc®**-Kugellagertechnik!

Additional value without additional price! Talk to your expert adviser.

No spiral spring, no flat spring!

These are integrated in almost every door handle set. It can hardly be avoided that individual windings touch due to the rotary movement and therefore produce friction. This may result in an unwanted scratching noise after pressing the handle only a few times.



No thin plastic ring as handle bearing

between metal cover plate and lever handle!

The most significant weak point of customary slide bearing sets. They have a thickness of at least 0.5 mm and can fray out even after a short time due to the friction of the handle projection.

The result is known – a wobbly axial bearing which significantly affects the function.

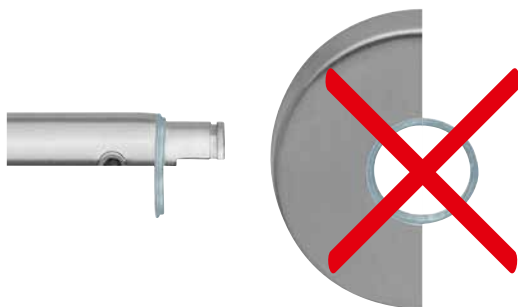



The Pullbloc® ball bearing system! The latest generation of handle bearing with return mechanism.

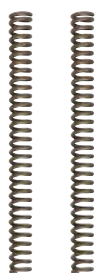

Compression springs

made of high-quality spring steel, produced in Germany! Running smoothly and uniformly, they steadily push the handle back into the required original position again and again.

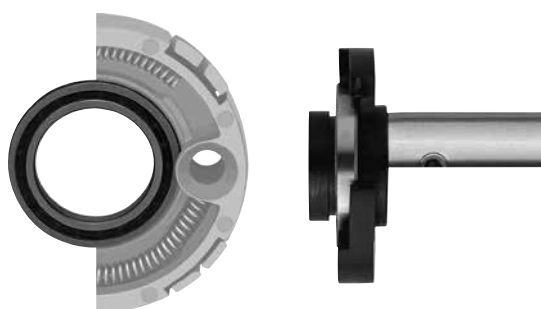

Original Pullbloc® ball bearing system!

The ball bearing of hardened steel was designed and developed particularly for these special strains. These guarantees a low-friction, noiseless rotary movement. Always look for the original **Pullbloc®** ball bearing system!

Technik im Detail

Die Stütznocken:

Erleichtern die Montage und verhindern das Verdrehen und Verrutschen an der Tür.

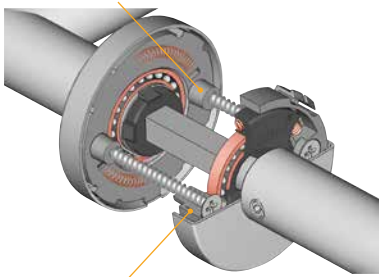

Die Montageelemente, die Basis:

Die Basis aus glasfaserverstärktem Polyamid besteht aus einem Guss und bietet dadurch die notwendige Statik. Sie ermöglichen gleichzeitig die Führung der Druckfedern und eine einwandfreie Klipverbindung mit der Deckrosette.

Gehärtete Stahl-Kugellager:

Die, direkt in die Basis eingepressten, **wartungsfreien Kugellager** aus gehärtetem Stahl, sorgen für die dauerhaft geschmeidige, wie auch geräuschlose Funktion.

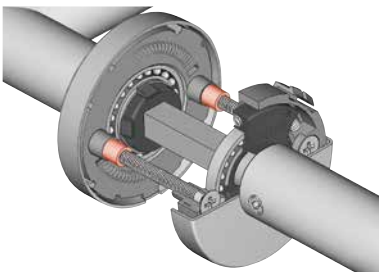

Die Bewegungselemente:

Die Verbindung zwischen Anker, Drücker und Vierkant ist **spielfrei**. Die Bewegung erfolgt gemeinsam, das verhindert jede Reibung am Drückeransatz und gewährleistet eine dauerhaft spielfreie, radiale wie axiale Führung der Drehbewegung. Der Anschlag nach oben verhindert ein Hochstehen des Drückers.

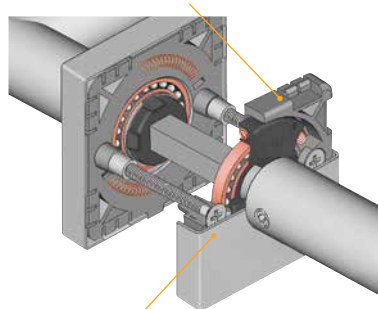

Die Rückstellelemente, die Federn:

Vier starke, vorgespannte Druckfedern schaffen konstanten Gegendruck von Beginn bis Ende jeder Betätigung und bringen die Drücker zuverlässig wieder in ihre Ursprungsposition.

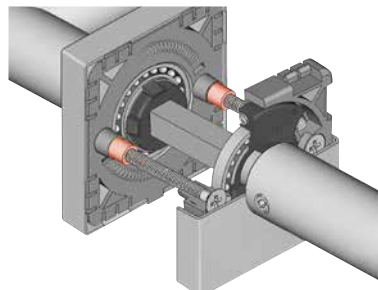

Verschraubung bei Türstärken ab 42 mm (Türstärken bei der Bestellung angeben): mit Gewindehülsen und M4 Verschraubung.



Technology in detail

The positioning studs:

Ease the installation and ensure a stable and durable connection to the door.

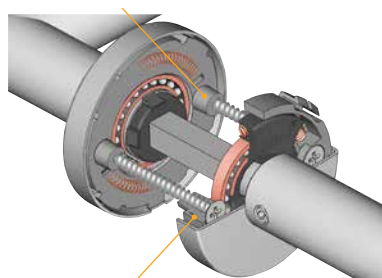

The mounting elements, the base:

The base made from glass-fibre reinforced polyamide is made in one piece and ensures the required static. It serves as guide for the compression springs and ensures a proper clip connection with the cover plates.

Hardened steel ball bearings:

The, pressed into the base, **maintenance-free ball bearings** made of hardened steel, guarantees a low-friction, noiseless rotary motion.

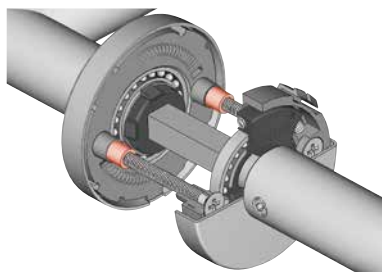

The motion elements:

The connection between anchor, handle and square bolt are **backlash-free**. They move together, which prevents any friction at the handle projection and ensures a permanently backlash-free radial and axial guide of the rotary movement. The upwards stop avoids that the handle stands up.

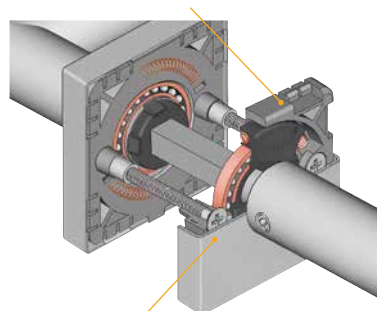

The restoring elements, the springs:

Four strong, pre-stressed **compression springs** create constant pressure from beginning to end of every single operation. Additional they return the handles back to their original position reliably.

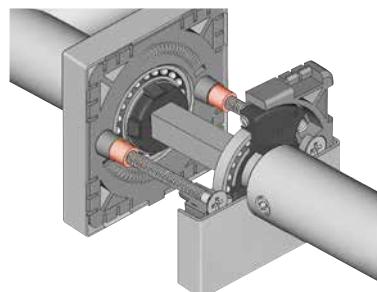

Screw connection for door **thicknesses from 42 mm** (specify the thicknesses of the door when ordering): with threaded sleeves and M4 screws..

Ehrliche, klare Argumente vereinfachen jede Beratung!

30 Jahre Garantie!

Über die gesetzliche Gewährleistung hinaus, erhalten Sie eine Garantie auf einwandfreie Funktion über 30 Jahre auf alle **Pullbloc®**-Kugellagersysteme!

Made in Germany!

Pullbloc® wurde in Deutschland entwickelt und wird in Deutschland produziert!

Langlebig und leise!

Das Kugellager aus gehärtetem Stahl sorgt für Langlebigkeit und Komfort. Durch die spielfreie Verbindung aller Komponenten ergeben sich keine Reibungspunkte. Keinerlei Abnutzung am **Drückeransatz**.

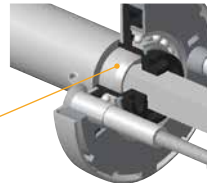

40 Sekunden Montage!

Pullbloc® wird weitgehend vormontiert geliefert. Die Montagezeit an der vorgebohrten Türe, Drücker- und Schlüsselrosetten beträgt nur 40 Sekunden!

Neu! Pullbloc® 3.0!

Bei der neuen **Pullbloc® 3.0**-Kugellagertechnik ist das Bewegungselement (der Anker) nicht mehr sichtbar und sorgt so für eine durchgängige Edelstahl-Optik.

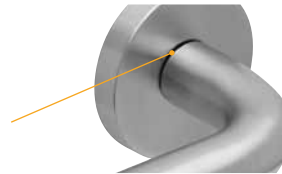

Jährliche Überwachung durch Prüfinstitute!

Funktion und Qualität von **Pullbloc®** werden von unabhängigen Prüfinstituten überwacht.

Das Patent!

Deutschland: DE 102005057766

Europa: EP 1793067

Alle genannten Informationen über Dauerhaftigkeit und Funktion sind durch ein unabhängiges Prüfinstitut geprüft und dokumentiert.



Honest, clear arguments simplify every consultation!

30 years of warranty!

Beyond statutory warranty, you get a warranty of perfect function over 30 years for all Pullbloc® ball bearing systems!

Made in Germany!

Pullbloc® has been designed in Germany and is produced in Germany!

Durable and noiseless!

The ball bearing of hardened steel provides durability and easy operation. Thanks to the backlash-free connection of all components, there are no points of friction. No wear of the **handle projection**.

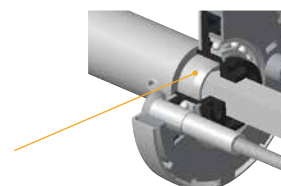

Assembled in 40 seconds!

Pullbloc® is delivered in a largely pre-assembled state. The assembly on the pre-drilled door, handle and key rosettes requires only 40 seconds!

New! Pullbloc® 3.0!

With the new Pullbloc® 3.0 ball bearing system, the motion element (the anchor) is no longer visible, thus ensures a consistent stainless steel look.

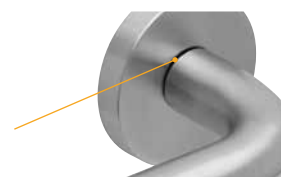

Annual monitoring by testing institutes!

Function and quality of Pullbloc® are monitored by independent testing institutes.

The patent!

Germany: DE 102005057766

Europe: EP 1793067

All mentioned information on durability and function is tested and documented by an independent testing institute.

Für die, die es interessiert!

Erklärung der DIN EN 1906

Gebrauchskategorie	Dauerhaftigkeit	Türmasse	Feuerbeständigkeit	Sicherheit	Korrosion	Einbruchsicherheit	Ausführungsart
1-4	6-7	–	0/A-D	0-1	0-5	0-4	A/B/U

Gebrauchskategorie:

Klasse 1

Zum Einsatz an Türen mit mittlerer Benutzungshäufigkeit durch Personen, die zu großer Sorgfalt motiviert sind und von denen ein geringes Risiko falscher Anwendung ausgeht (z. B. Innentüren von Wohnräumen).

Klasse 2

Zum Einsatz an Türen mit mittlerer Benutzungshäufigkeit durch Personen, die zur Sorgfalt motiviert sind, wobei jedoch ein gewisses Risiko falscher Anwendung besteht (z. B. Innentüren in Bürogebäuden).

Klasse 3

Zum Einsatz an Türen mit häufiger Benutzung durch Publikum oder andere Personen mit geringer Motivation zur Sorgfalt und bei denen ein hohes Risiko falscher Anwendung besteht (z. B. Türen in Bürogebäuden mit Publikumsverkehr).

Klasse 4

Zum Einsatz an Türen, die häufig Gewaltanwendungen oder Sachbeschädigungen ausgesetzt sind (z. B. Türen in Fußballstadien, auf Ölbohrinseln, in Kasernen oder öffentlichen Toiletten).

Dauerhaftigkeit:

Klasse 6

mittlere Benutzungshäufigkeit = 100.000 Prüfzyklen

Klasse 7

hohe Benutzungshäufigkeit = 200.000 Prüfzyklen

scoop® prüft Pullbloc® Bewegungsmechanismen für Türgriffe auf Dauerhaftigkeit nicht unter 1.000.000 Zyklen und mit erheblich höheren „Danach-Kriterien“ als es die DIN EN 1906 nach nur 200.000 Zyklen vorgibt.

Türmasse:

Keine Klassifizierung

Türmasse steht für das Gewicht der Türe.

Feuerbeständigkeit:

Mögliche Klassen:

0, A, A1, B, B1, C, C1, D oder D1

Klasse 0

nicht zulässig an Feuer- und Rauchschtüren

Klasse A

geeignet für Rauchschtüren

Klasse A1

geeignet für Rauchschtüren (mit 200.000 Prüfzyklen an einer Prüftür geprüft)

Klasse B

geeignet für Rauch- und Feuerschtüren (mit 200.000 Prüfzyklen geprüft)

Klasse B1

geeignet für Rauch- und Feuerschtüren (mit 200.000 Prüfzyklen an einer Prüftür geprüft)

Klasse C

geeignet für Rauch- und Feuerschtüren mit Anforderungen an Feuerschutzeinlagen in Schild, Türrosette und Schlüsselrosette

Klasse C1

geeignet für Rauch- und Feuerschtüren mit Anforderungen an Feuerschutzeinlagen in Schild, Türrosette und Schlüsselrosette (mit 200.000 Prüfzyklen an einer Prüftür geprüft)

Klasse D

geeignet für Rauch- und Feuerschtüren mit Anforderungen an einen Stahlkern im Griff

Klasse D1

geeignet für Rauch- und Feuerschtüren mit Anforderungen an einen Stahlkern im Griff (mit 200.000 Prüfzyklen an einer Prüftür geprüft)



Sicherheit:

Klasse 0
normale Anforderung

Klasse 1
Sicherheitsanforderung

Sicherheit steht für die Gebrauchssicherheit unter erhöhter Belastung (Türdrücker die auch als Haltegriff verwendet werden oder für besonders schwere Türen, ...).

Korrosion:

Klasse 0
keine Festlegung

Klasse 1
gering

Klasse 2
mäßig

Klasse 3
hoch

Klasse 4
sehr hoch

Klasse 5
extrem hoch

Einbruchssicherheit:

Klasse 0
keine Leistung festgelegt

Klasse 1
gering einbruchhemmend
= DIN 18257 Widerstandskl. ES0

Klasse 2
mäßig einbruchhemmend
= DIN 18257 Widerstandskl. ES1

Klasse 3
stark einbruchhemmend
= DIN 18257 Widerstandskl. ES2

Klasse 4
extrem einbruchhemmend
= DIN 18257 Widerstandskl. ES3

Ausführungsart:

Ausführung A
mit Federunterstützung

Ausführung B
mit Federvorspannung

Ausführung U
ohne Federvorspannung

For those who would like to know!

Explanation of DIN EN 1906

Category of use	Durability	Door mass	Fire resistance	Safety	Corrosion resistance	Security	Type of operation
1-4	6-7	–	0/A-D	0-1	0-5	0-4	A/B/U

Category of use:

Class 1

For application on doors with medium frequency of use by persons with high incentive to exercise care and low chance of misuse (e.g. internal residential doors).

Class 2

For application on doors with medium frequency of use by persons with high incentive to exercise care, but some chance of misuse (e.g. internal office doors).

Class 3

For application on doors with high frequency of use by the public or others with little incentive to exercise care and high chance of misuse (e.g. public office doors).

Class 4

For application on doors frequently subject to violent use or damage (e.g. doors in soccer stadiums, on offshore oil rigs, in barracks or public restrooms).

Durability:

Class 6

Medium frequency of use = 100,000 test cycles

Class 7

High frequency of use = 200,000 test cycles

scoop® tests Pull-bloc® movement mechanisms for door handles for durability not below 1,000,000 cycles and with clearly higher "after criteria" as specified by DIN EN 1906 after only 200,000 cycles.

Door mass:

No classification

Door mass stands for the weight of the door.

Fire resistance:

Grades

0, A, A1, B, B1, C, C1, D or D1

Class 0

Not approved for use on fire/smoke door assemblies

Class A

Suitable for use on smoke door assemblies

Class A1

Suitable for use on smoke door assemblies (tested with 200,000 test cycles on a test door)

Class B

Suitable for use on fire/smoke door assemblies (tested with 200,000 test cycles)

Class B1

Suitable for use on fire/smoke door assemblies (tested with 200,000 test cycles on a test door)

Class C

Suitable for use on smoke and fire-resistant doors with requirements for fire-resistant dividers in backplate, door rose and escutcheon

Class C1

Suitable for use on smoke and fire-resistant doors with requirements for fire-resistant dividers in backplate, door rose and escutcheon (tested with 200,000 test cycles on a test door)

Class D

Suitable for use on fire/smoke door assemblies with require for a steel core in the handle

Class D1

Suitable for use on fire/smoke door assemblies with require for a steel core in the handle (tested with 200,000 test cycles on a test door)



Safety:

Class 0
Normal requirements

Class 1
Safety requirements

Safety stands for the safety of use under increased stress (door handle also used as strap or for particularly heavy doors, ...).

Corrosion resistance:

Class 0
Not defined

Class 1
Low

Class 2
Moderate

Class 3
High

Class 4
Very high

Class 5
Extra high

Security:

Class 0
No performance defined

Class 1
Low burglary resistance
= DIN 18257 resistance class
ES0

Class 2
Moderate burglary resistance
= DIN 18257 resistance class
ES1

Class 3
High burglary resistance
= DIN 18257 resistance class
ES2

Class 4
Extra high burglary resistance
= DIN 18257 resistance class
ES3

Type of operation:

Type A
spring-assisted

Type B
spring-loaded

Type U
unsprung

Kombinationsmöglichkeiten



**Rosetten
rund**
ab Seite 27

**Rosetten
Quadrat**
ab Seite 27

**Flächenbündige
Optik**
ab Seite 220

**Quadratrossetten
flach**
ab Seite 220



**Langschild
Standard**
ab Seite 234

**Kurzschild
Standard**
ab Seite 240

**Langschild
schmal**
ab Seite 236

**Kurzschild
schmal**
ab Seite 242

Schnellübersicht Formen auf Rundrosette

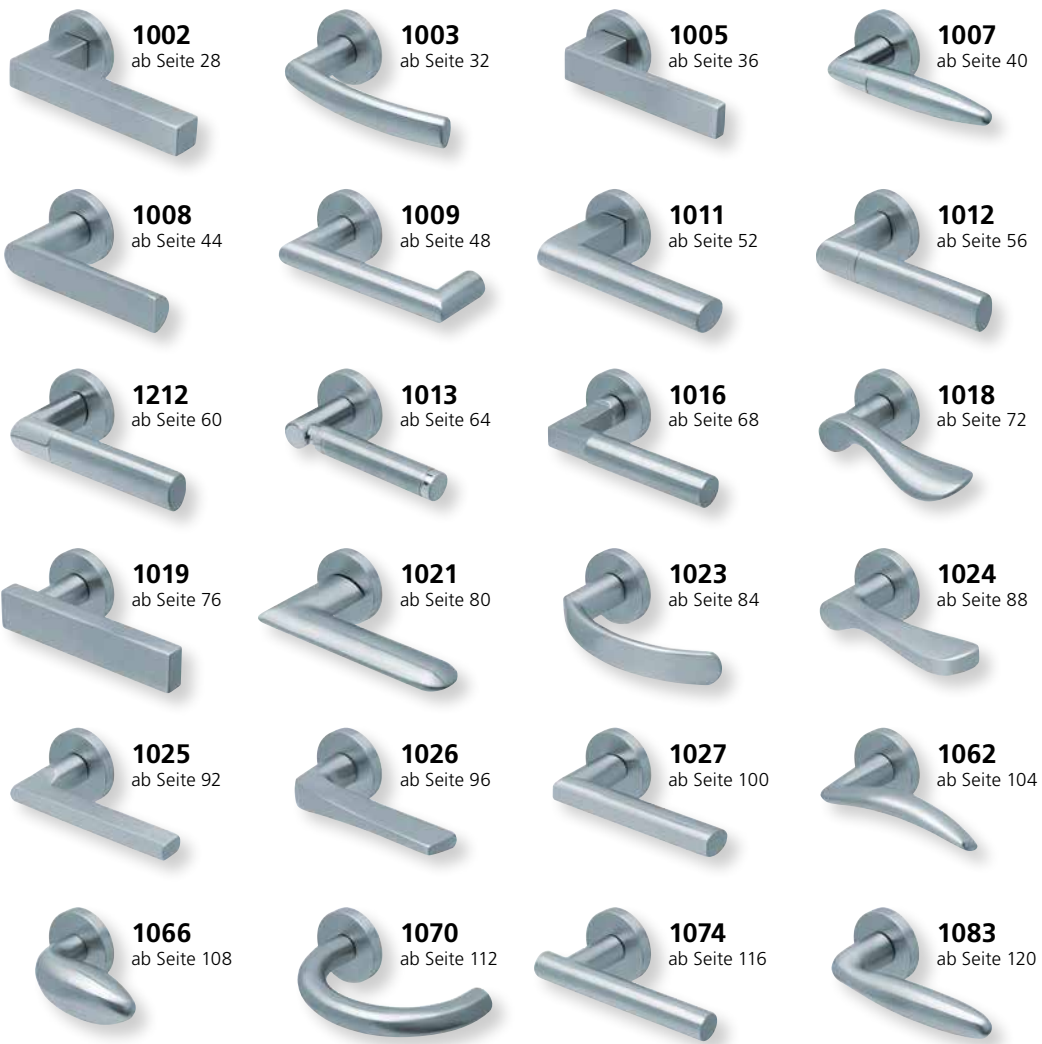



1084
ab Seite 124



1085
ab Seite 128



1100
ab Seite 132



1101
ab Seite 136



1103
ab Seite 140



1104
ab Seite 144



1106
ab Seite 148



1107
ab Seite 152



1108
ab Seite 156



1109
ab Seite 160



1173
ab Seite 164



1174
ab Seite 168



1200
ab Seite 172



1206
ab Seite 176



1275
ab Seite 180



1764
ab Seite 184



1765
ab Seite 188



1X74
ab Seite 192

Schnellübersicht Formen auf Quadratrosette

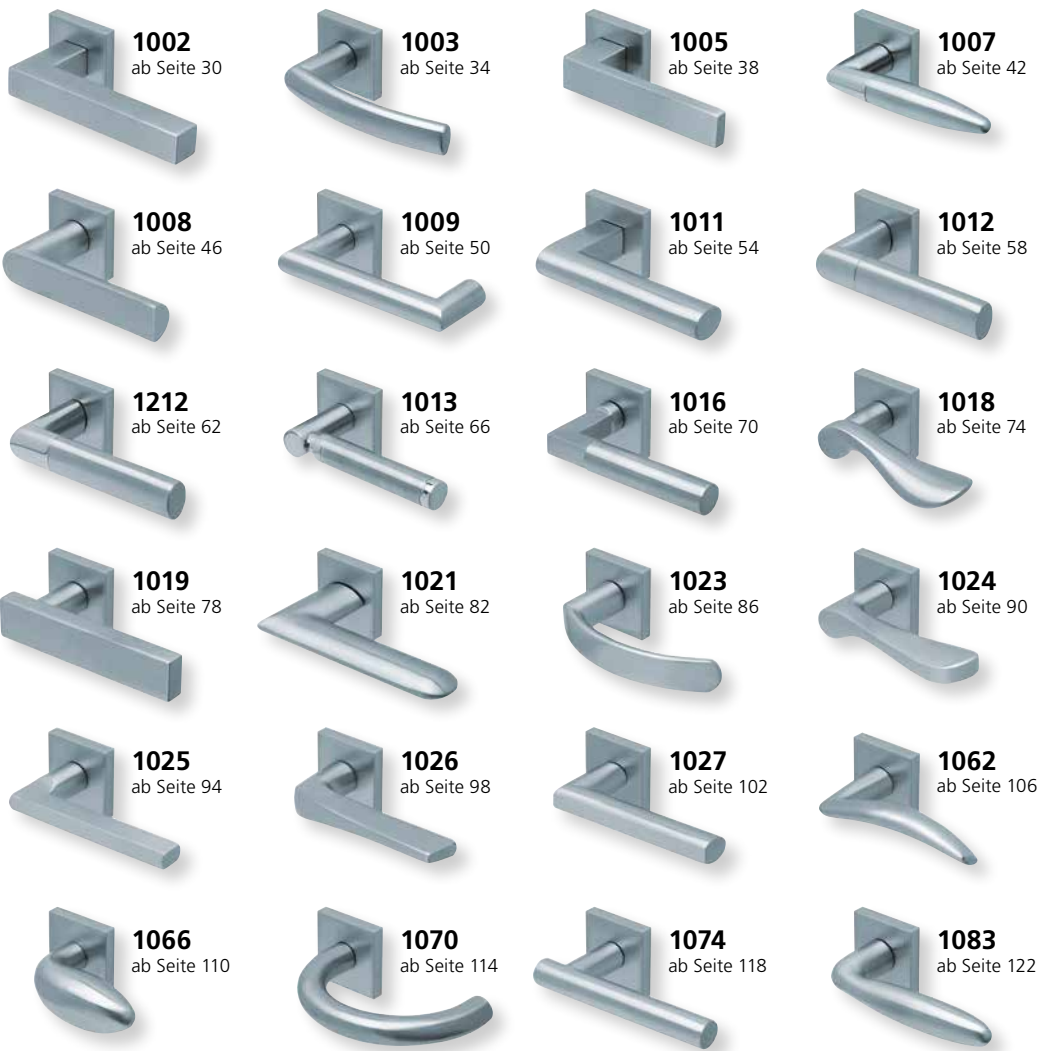



1084
ab Seite 126



1085
ab Seite 130



1100
ab Seite 134



1101
ab Seite 138



1103
ab Seite 142



1104
ab Seite 146



1106
ab Seite 150



1107
ab Seite 154



1108
ab Seite 158



1109
ab Seite 162



1173
ab Seite 166



1174
ab Seite 170



1200
ab Seite 174



1206
ab Seite 178



1275
ab Seite 182



1764
ab Seite 186



1765
ab Seite 190



1X74
ab Seite 194

Schnellübersicht Formen auf Rundrosette PVD Messinggelb



1002
ab Seite 28



1005
ab Seite 36



1008
ab Seite 44



1016
ab Seite 68



1018
ab Seite 72



1021
ab Seite 80



1024
ab Seite 88



1025
ab Seite 92



1026
ab Seite 96



1083
ab Seite 120



1084
ab Seite 124



1085
ab Seite 128



1103
ab Seite 140



Schnellübersicht Formen auf Quadratrosette PVD Messinggelb



Von Seite 27 bis Seite 195 finden Sie Türdrückergarnituren
zertifiziert nach **DIN EN 1906 GK3** laut folgendem Schlüssel.

Gebrauchs- kategorie	Dauer- haftigkeit	Türmasse	Feuerbe- ständigkeit	Sicherheit	Korrosion	Einbruch- sicherheit	Ausfüh- rungsart
3	7	-	0	0	4	0	B

Erklärung der **DIN EN 1906** auf den Seiten 14 und 15.

Einleitung	ab	2
Kombinationsmöglichkeiten	ab	18
Schnellübersicht Formen	ab	20

Privat- und Objektbau GK3

Feuerschutzgarnituren	ab	197
Rosetten/Knöpfe/Schilder	ab	211
Office Glastürbeschläge	ab	247
Glastürbeschläge	ab	253
Fenstergriffe	ab	277
Sicherheit	ab	311
Stoßgriffe	ab	331
Muschelgriffe	ab	342
Türstopper	ab	347
Türfixierer	ab	349
Hausnummern	ab	350
Buchstaben und Hinweisschilder	ab	351

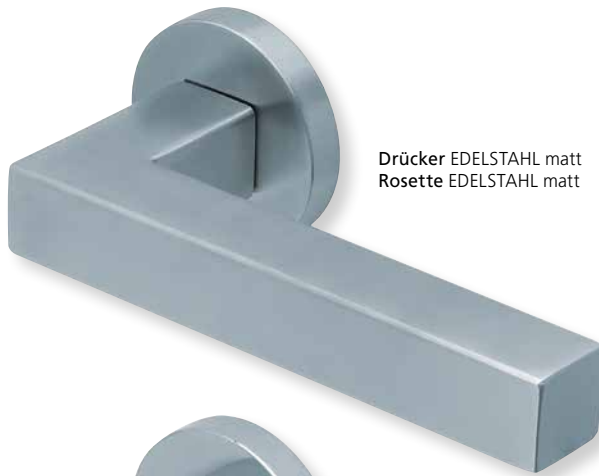

Drücker EDELSTAHL matt
Rosette EDELSTAHL matt



Drücker EDELSTAHL poliert
Rosette EDELSTAHL poliert

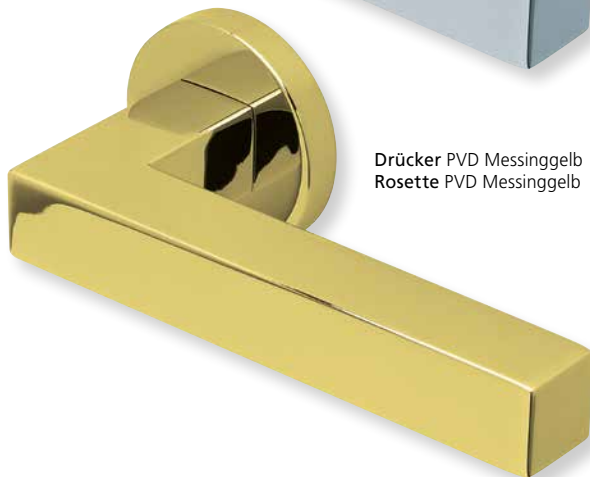

Drücker PVD Messinggelb
Rosette PVD Messinggelb

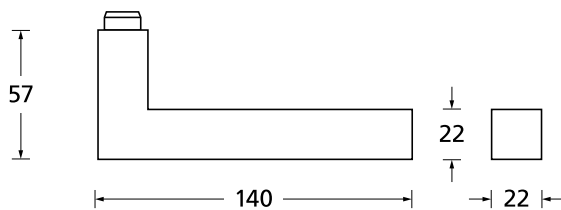



Pullbloc® 3.0 Kugellagertechnik

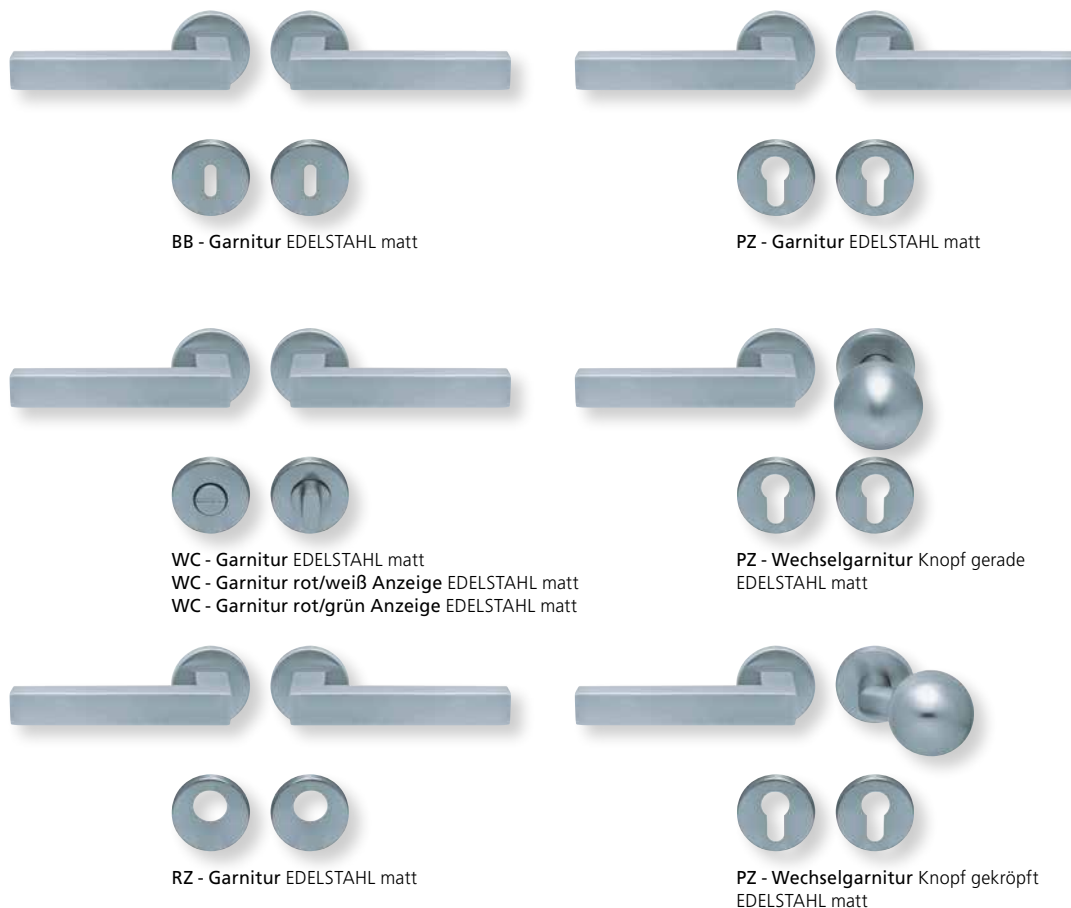

Form 1002 auf Rundrosette

	Edelstahl matt		Edelstahl poliert		PVD Messinggelb	
	€ exkl. MwSt.		€ exkl. MwSt.		€ exkl. MwSt.	
Rosettengarnitur						
BB - Garnitur	PB3.0-10020	47,90	PB3.0-P10020	57,90	PB3.0-PVM10020	67,90
PZ - Garnitur	PB3.0-10022	47,90	PB3.0-P10022	57,90	PB3.0-PVM10022	67,90
OS - Garnitur (ohne Schlüsselrosette)	PB3.0-1002OS	43,90	PB3.0-P1002OS	53,90	PB3.0-PVM1002OS	63,90
RZ - Garnitur	PB3.0-10028	47,90	PB3.0-P10028	57,90	PB3.0-PVM10028	67,90
WC - Garnitur	PB3.0-10023	57,90	PB3.0-P10023	67,90	PB3.0-PVM10023	77,90
WC - Garnitur rot/weiß Anz.	PB3.0-100231	61,90	PB3.0-P100231	71,90	PB3.0-PVM100231	81,90
WC - Garnitur rot/grün Anz.	PB3.0-100232	61,90	PB3.0-P100232	71,90	PB3.0-PVM100232	81,90
PZ-WG - Knopf ger. DIN R/L	PB3.0-10025/6	61,90	PB3.0-P10025/6	71,90	PB3.0-PVM10025/6	81,90
PZ-WG - Knopf gekr. DIN R/L	PB3.0-100251/61	65,90	PB3.0-P100251/61	75,90	PB3.0-PVM100251/61	85,90
Drückerpaar						
ohne Rosetten	D10020	25,90	DP10020	33,90	DPVM10020	41,90

Standard-Türstärken: 38 - 42 mm
 Aufpreis für Türstärken ab 42 mm: € 5,00

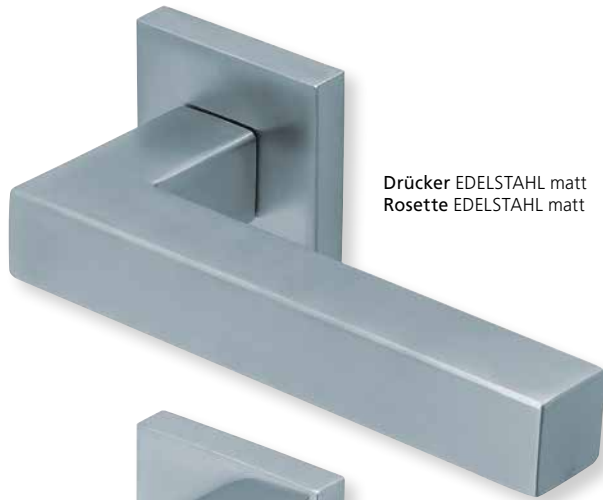

Drücker EDELSTAHL matt
Rosette EDELSTAHL matt



Drücker EDELSTAHL poliert
Rosette EDELSTAHL poliert

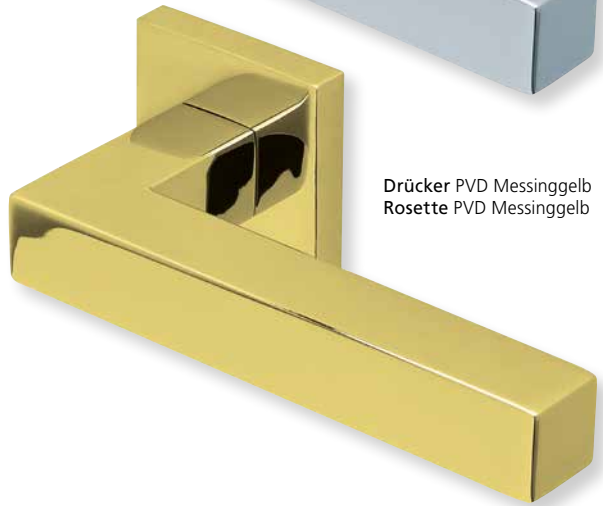

Drücker PVD Messinggelb
Rosette PVD Messinggelb

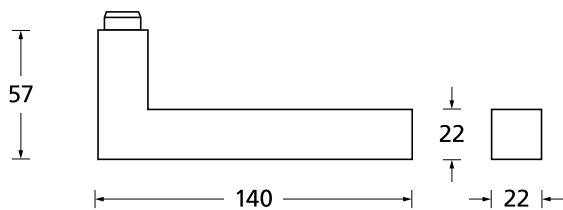



Pullbloc® 3.0 Kugellagertechnik

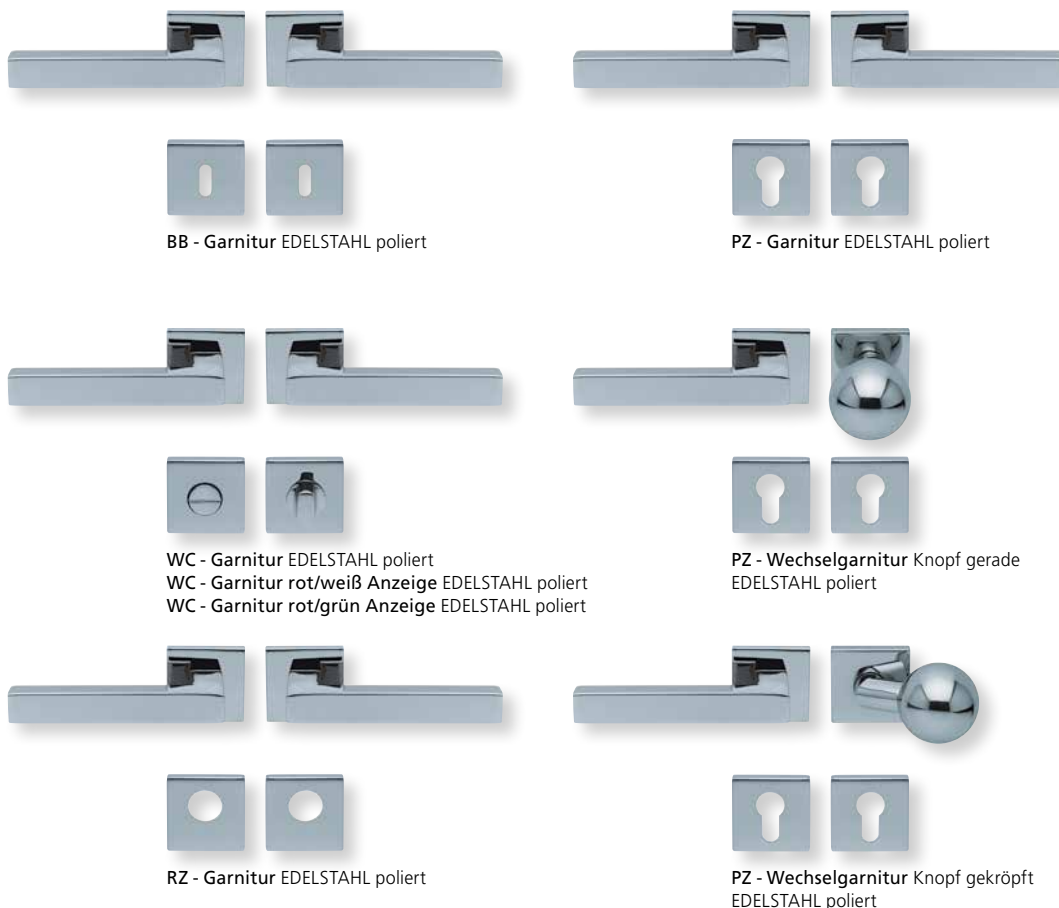

Form 1002 auf Quadratrosette

	Edelstahl matt		Edelstahl poliert		PVD Messinggelb	
	€ exkl. MwSt.		€ exkl. MwSt.		€ exkl. MwSt.	
Rosettengarnitur						
BB - Garnitur	PB3.0-Q10020	53,90	PB3.0-QP10020	63,90	PB3.0-QPVM10020	73,90
PZ - Garnitur	PB3.0-Q10022	53,90	PB3.0-QP10022	63,90	PB3.0-QPVM10022	73,90
OS - Garnitur (ohne Schlüsselrosette)	PB3.0-Q10020S	49,90	PB3.0-QP10020S	59,90	PB3.0-QPVM10020S	69,90
RZ - Garnitur	PB3.0-Q10028	53,90	PB3.0-QP10028	63,90	PB3.0-QPVM10028	73,90
WC - Garnitur	PB3.0-Q10023	63,90	PB3.0-QP10023	73,90	PB3.0-QPVM10023	83,90
WC - Garnitur rot/weiß Anz.	PB3.0-Q100231	67,90	PB3.0-QP100231	77,90	PB3.0-QPVM100231	87,90
WC - Garnitur rot/grün Anz.	PB3.0-Q100232	67,90	PB3.0-QP100232	77,90	PB3.0-QPVM100232	87,90
PZ-WG - Knopf ger. DIN R/L	PB3.0-Q10025/6	67,90	PB3.0-QP10025/6	77,90	PB3.0-QPVM10025/6	87,90
PZ-WG - Knopf gekr. DIN R/L	PB3.0-Q100251/61	71,90	PB3.0-QP100251/61	81,90	PB3.0-QPVM100251/61	91,90
Drückerpaar						
ohne Rosetten	D10020	25,90	DP10020	33,90	DPVM10020	41,90

Standard-Türstärken: 38 - 42 mm
 Aufpreis für Türstärken ab 42 mm: € 5,00



Drücker EDELSTAHL matt
Rosette EDELSTAHL matt



Drücker EDELSTAHL poliert
Rosette EDELSTAHL poliert

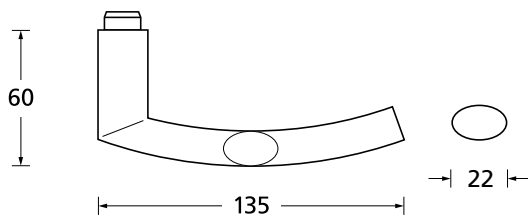



Pullbloc® 3.0 Kugellagertechnik

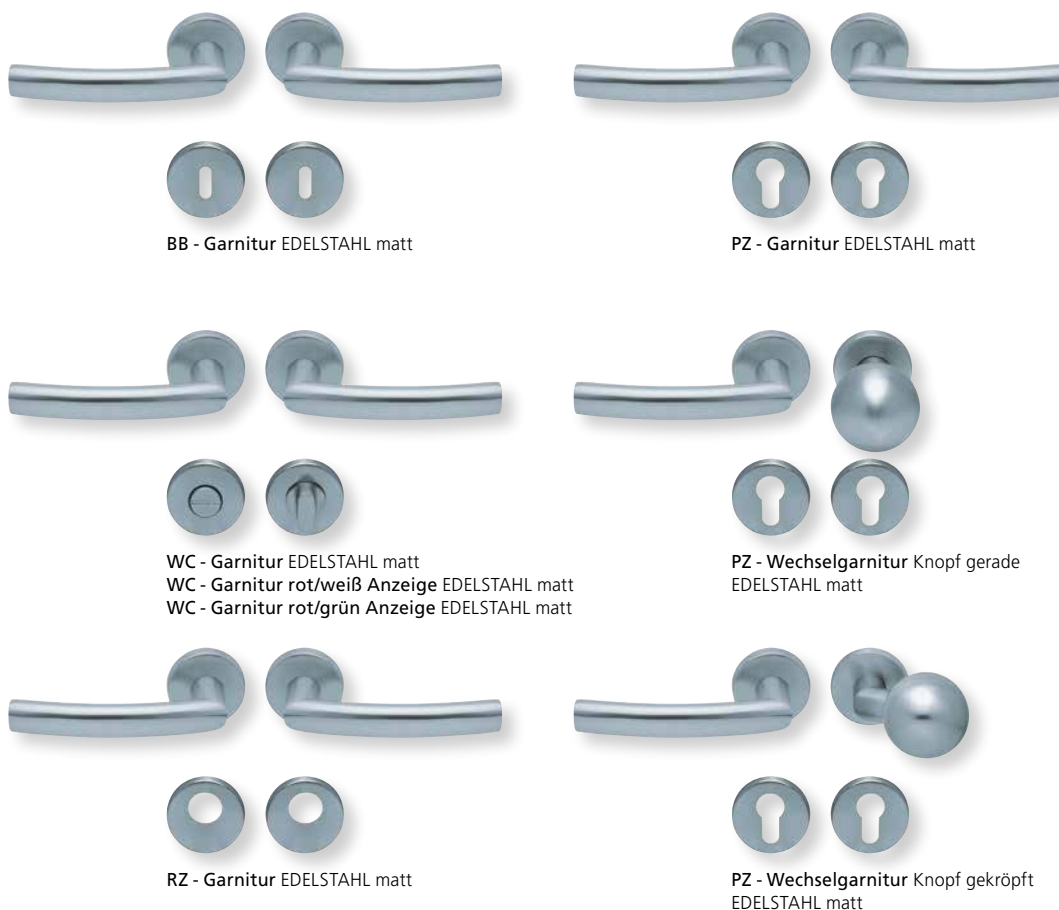

Form 1003 auf Rundrosette

	Edelstahl matt		Edelstahl poliert	
		€ exkl. MwSt.		€ exkl. MwSt.
Rosettengarnitur				
BB - Garnitur	PB3.0-10030	47,90	PB3.0-P10030	57,90
PZ - Garnitur	PB3.0-10032	47,90	PB3.0-P10032	57,90
OS - Garnitur (ohne Schlüsselrosette)	PB3.0-1003OS	43,90	PB3.0-P1003OS	53,90
RZ - Garnitur	PB3.0-10038	47,90	PB3.0-P10038	57,90
WC - Garnitur	PB3.0-10033	57,90	PB3.0-P10033	67,90
WC - Garnitur rot/weiß Anz.	PB3.0-100331	61,90	PB3.0-P100331	71,90
WC - Garnitur rot/grün Anz.	PB3.0-100332	61,90	PB3.0-P100332	71,90
PZ-WG - Knopf ger. DIN R/L	PB3.0-10035/6	61,90	PB3.0-P10035/6	71,90
PZ-WG - Knopf gekr. DIN R/L	PB3.0-100351/61	65,90	PB3.0-P100351/61	75,90
Drückerpaar				
ohne Rosetten	D10030	25,90	DP10030	33,90

Standard-Türstärken: 38 - 42 mm
Aufpreis für Türstärken ab 42 mm: € 5,00



Drücker EDELSTAHL matt
Rosette EDELSTAHL matt



Drücker EDELSTAHL poliert
Rosette EDELSTAHL poliert

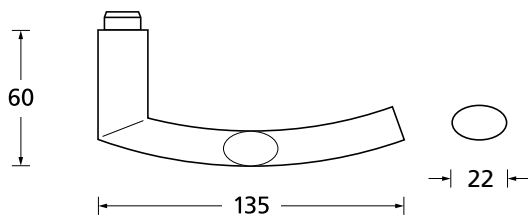



Pullbloc® 3.0 Kugellagertechnik



BB - Garnitur EDELSTAHL poliert



PZ - Garnitur EDELSTAHL poliert



WC - Garnitur EDELSTAHL poliert
WC - Garnitur rot/weiß Anzeige EDELSTAHL poliert
WC - Garnitur rot/grün Anzeige EDELSTAHL poliert



PZ - Wechselgarnitur Knopf gerade EDELSTAHL poliert



RZ - Garnitur EDELSTAHL poliert



PZ - Wechselgarnitur Knopf gekröpft EDELSTAHL poliert

Form 1003 auf Quadratrosette

	Edelstahl matt		Edelstahl poliert	
		€ exkl. MwSt.		€ exkl. MwSt.
Rosettengarnitur				
BB - Garnitur	PB3.0-Q10030	53,90	PB3.0-QP10030	63,90
PZ - Garnitur	PB3.0-Q10032	53,90	PB3.0-QP10032	63,90
OS - Garnitur (ohne Schlüsselrosette)	PB3.0-Q10030S	49,90	PB3.0-QP10030S	59,90
RZ - Garnitur	PB3.0-Q10038	53,90	PB3.0-QP10038	63,90
WC - Garnitur	PB3.0-Q10033	63,90	PB3.0-QP10033	73,90
WC - Garnitur rot/weiß Anz.	PB3.0-Q100331	67,90	PB3.0-QP100331	77,90
WC - Garnitur rot/grün Anz.	PB3.0-Q100332	67,90	PB3.0-QP100332	77,90
PZ-WG - Knopf ger. DIN R/L	PB3.0-Q10035/6	67,90	PB3.0-QP10035/6	77,90
PZ-WG - Knopf gekr. DIN R/L	PB3.0-Q100351/61	71,90	PB3.0-QP100351/61	81,90
Drückerpaar				
ohne Rosetten	D10030	25,90	DP10030	33,90

Standard-Türstärken: 38 - 42 mm
Aufpreis für Türstärken ab 42 mm: € 5,00



Drücker EDELSTAHL matt
Rosette EDELSTAHL matt



Drücker EDELSTAHL poliert
Rosette EDELSTAHL poliert



Drücker PVD Messinggelb
Rosette PVD Messinggelb

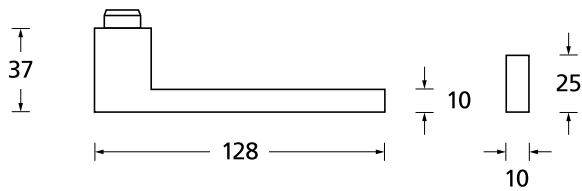



Pullbloc® 3.0 Kugellagertechnik



BB - Garnitur EDELSTAHL matt



PZ - Garnitur EDELSTAHL matt



WC - Garnitur EDELSTAHL matt
WC - Garnitur rot/weiß Anzeige EDELSTAHL matt
WC - Garnitur rot/grün Anzeige EDELSTAHL matt



PZ - Wechselgarnitur Knopf gerade
EDELSTAHL matt



RZ - Garnitur EDELSTAHL matt



PZ - Wechselgarnitur Knopf gekröpft
EDELSTAHL matt

Form 1005 auf Rundrosette

	Edelstahl matt		Edelstahl poliert		PVD Messinggelb	
	€ exkl. MwSt.		€ exkl. MwSt.		€ exkl. MwSt.	
Rosettengarnitur						
BB - Garnitur	PB3.0-10050	53,90	PB3.0-P10050	63,90	PB3.0-PVM10050	73,90
PZ - Garnitur	PB3.0-10052	53,90	PB3.0-P10052	63,90	PB3.0-PVM10052	73,90
OS - Garnitur (ohne Schlüsselrosette)	PB3.0-10050S	49,90	PB3.0-P10050S	59,90	PB3.0-PVM10050S	69,90
RZ - Garnitur	PB3.0-10058	53,90	PB3.0-P10058	63,90	PB3.0-PVM10058	73,90
WC - Garnitur	PB3.0-10053	63,90	PB3.0-P10053	73,90	PB3.0-PVM10053	83,90
WC - Garnitur rot/weiß Anz.	PB3.0-100531	67,90	PB3.0-P100531	77,90	PB3.0-PVM100531	87,90
WC - Garnitur rot/grün Anz.	PB3.0-100532	67,90	PB3.0-P100532	77,90	PB3.0-PVM100532	87,90
PZ-WG - Knopf ger. DIN R/L	PB3.0-10055/6	67,90	PB3.0-P10055/6	77,90	PB3.0-PVM10055/6	87,90
PZ-WG - Knopf gekr. DIN R/L	PB3.0-100551/61	71,90	PB3.0-P100551/61	81,90	PB3.0-PVM100551/61	91,90
Drückerpaar						
ohne Rosetten	D10050	29,90	DP10050	37,90	DPVM10050	45,90

Standard-Türstärken: 38 - 42 mm
Aufpreis für Türstärken ab 42 mm: € 5,00

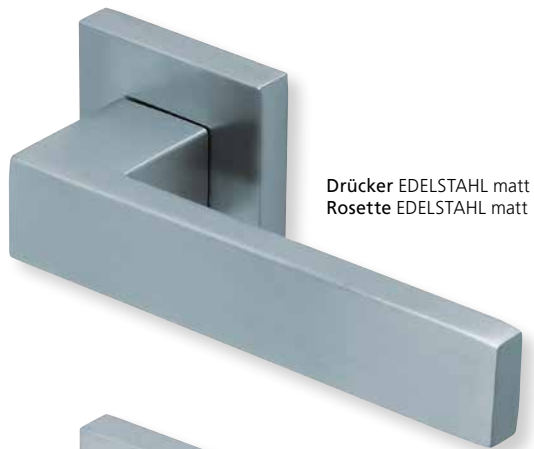

Drücker EDELSTAHL matt
Rosette EDELSTAHL matt



Drücker EDELSTAHL poliert
Rosette EDELSTAHL poliert

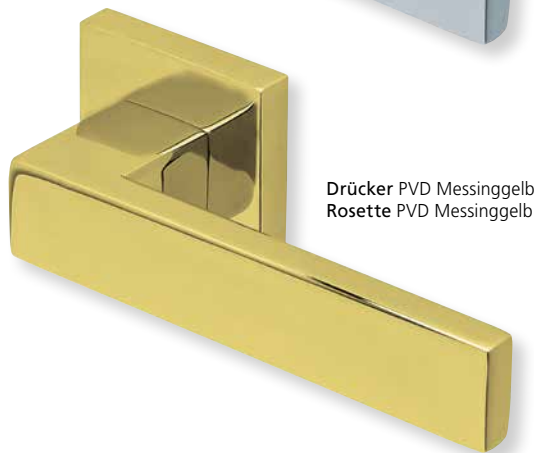

Drücker PVD Messinggelb
Rosette PVD Messinggelb

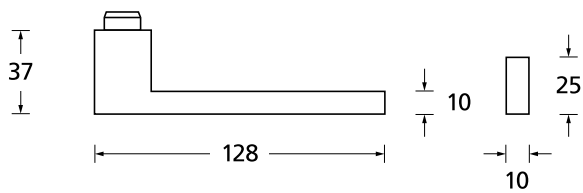



Pullbloc® 3.0 Kugellagertechnik



BB - Garnitur EDELSTAHL poliert



PZ - Garnitur EDELSTAHL poliert



WC - Garnitur EDELSTAHL poliert
WC - Garnitur rot/weiß Anzeige EDELSTAHL poliert
WC - Garnitur rot/grün Anzeige EDELSTAHL poliert



PZ - Wechselgarnitur Knopf gerade EDELSTAHL poliert



RZ - Garnitur EDELSTAHL poliert



PZ - Wechselgarnitur Knopf gekröpft EDELSTAHL poliert

Form 1005 auf Quadratrosette

	Edelstahl matt		Edelstahl poliert		PVD Messinggelb	
	€ exkl. MwSt.		€ exkl. MwSt.		€ exkl. MwSt.	
Rosettengarnitur						
BB - Garnitur	PB3.0-Q10050	59,90	PB3.0-QP10050	69,90	PB3.0-QPVM10050	79,90
PZ - Garnitur	PB3.0-Q10052	59,90	PB3.0-QP10052	69,90	PB3.0-QPVM10052	79,90
OS - Garnitur (ohne Schlüsselrosette)	PB3.0-Q10050S	55,90	PB3.0-QP10050S	65,90	PB3.0-QPVM10050S	75,90
RZ - Garnitur	PB3.0-Q10058	59,90	PB3.0-QP10058	69,90	PB3.0-QPVM10058	79,90
WC - Garnitur	PB3.0-Q10053	69,90	PB3.0-QP10053	79,90	PB3.0-QPVM10053	89,90
WC - Garnitur rot/weiß Anz.	PB3.0-Q100531	73,90	PB3.0-QP100531	83,90	PB3.0-QPVM100531	93,90
WC - Garnitur rot/grün Anz.	PB3.0-Q100532	73,90	PB3.0-QP100532	83,90	PB3.0-QPVM100532	93,90
PZ-WG - Knopf ger. DIN R/L	PB3.0-Q10055/6	73,90	PB3.0-QP10055/6	83,90	PB3.0-QPVM10055/6	93,90
PZ-WG - Knopf gekr. DIN R/L	PB3.0-Q100551/61	77,90	PB3.0-QP100551/61	87,90	PB3.0-QPVM100551/61	97,90
Drückerpaar						
ohne Rosetten	D10050	29,90	DP10050	37,90	DPVM10050	45,90

Standard-Türstärken: 38 - 42 mm
Aufpreis für Türstärken ab 42 mm: € 5,00



Drücker EDELSTAHL poliert/EDELSTAHL matt
Rosette EDELSTAHL matt



Drücker EDELSTAHL poliert/EDELSTAHL matt
Rosette EDELSTAHL poliert

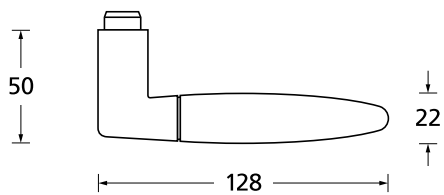



Pullbloc® 3.0 Kugellagertechnik



BB - Garnitur EDELSTAHL poliert



PZ - Garnitur EDELSTAHL poliert



WC - Garnitur EDELSTAHL poliert
WC - Garnitur rot/weiß Anzeige EDELSTAHL poliert
WC - Garnitur rot/grün Anzeige EDELSTAHL poliert



PZ - Wechselgarnitur Knopf gerade
EDELSTAHL poliert



RZ - Garnitur EDELSTAHL poliert



PZ - Wechselgarnitur Knopf gekröpft
EDELSTAHL poliert

Form 1007 auf Rundrosette

	Edelstahl matt		Edelstahl poliert	
		€ exkl. MwSt.		€ exkl. MwSt.
Rosettengarnitur				
BB - Garnitur	PB3.0-10070	53,90	PB3.0-P10070	59,90
PZ - Garnitur	PB3.0-10072	53,90	PB3.0-P10072	59,90
OS - Garnitur (ohne Schlüsselrosette)	PB3.0-1007OS	49,90	PB3.0-P1007OS	55,90
RZ - Garnitur	PB3.0-10078	53,90	PB3.0-P10078	59,90
WC - Garnitur	PB3.0-10073	63,90	PB3.0-P10073	69,90
WC - Garnitur rot/weiß Anz.	PB3.0-100731	67,90	PB3.0-P100731	73,90
WC - Garnitur rot/grün Anz.	PB3.0-100732	67,90	PB3.0-P100732	73,90
PZ-WG - Knopf ger. DIN R/L	PB3.0-10075/6	67,90	PB3.0-P10075/6	73,90
PZ-WG - Knopf gekr. DIN R/L	PB3.0-100751/61	71,90	PB3.0-P100751/61	77,90
Drückerpaar				
ohne Rosetten	D10070	29,90	D10070	29,90

Standard-Türstärken: 38 - 42 mm
Aufpreis für Türstärken ab 42 mm: € 5,00



Drücker EDELSTAHL poliert/EDELSTAHL matt
Rosette EDELSTAHL matt



Drücker EDELSTAHL poliert/EDELSTAHL matt
Rosette EDELSTAHL poliert

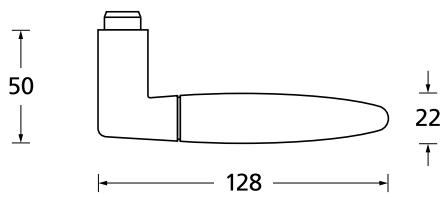



Pullbloc® 3.0 Kugellagertechnik



BB - Garnitur EDELSTAHL poliert



PZ - Garnitur EDELSTAHL poliert



WC - Garnitur EDELSTAHL poliert
WC - Garnitur rot/weiß Anzeige EDELSTAHL poliert
WC - Garnitur rot/grün Anzeige EDELSTAHL poliert



PZ - Wechselgarnitur Knopf gerade EDELSTAHL poliert



RZ - Garnitur EDELSTAHL poliert



PZ - Wechselgarnitur Knopf gekröpft EDELSTAHL poliert

Form 1007 auf Quadratrossette

	Edelstahl matt		Edelstahl poliert	
		€ exkl. MwSt.		€ exkl. MwSt.
Rosettengarnitur				
BB - Garnitur	PB3.0-Q10070	59,90	PB3.0-QP10070	65,90
PZ - Garnitur	PB3.0-Q10072	59,90	PB3.0-QP10072	65,90
OS - Garnitur (ohne Schlüsselrossette)	PB3.0-Q1007OS	55,90	PB3.0-QP1007OS	61,90
RZ - Garnitur	PB3.0-Q10078	59,90	PB3.0-QP10078	65,90
WC - Garnitur	PB3.0-Q10073	69,90	PB3.0-QP10073	75,90
WC - Garnitur rot/weiß Anz.	PB3.0-Q100731	73,90	PB3.0-QP100731	79,90
WC - Garnitur rot/grün Anz.	PB3.0-Q100732	73,90	PB3.0-QP100732	79,90
PZ-WG - Knopf ger. DIN R/L	PB3.0-Q10075/6	73,90	PB3.0-QP10075/6	79,90
PZ-WG - Knopf gekr. DIN R/L	PB3.0-Q100751/61	77,90	PB3.0-QP100751/61	83,90
Drückerpaar				
ohne Rosetten	D10070	29,90	D10070	29,90

Standard-Türstärken: 38 - 42 mm
Aufpreis für Türstärken ab 42 mm: € 5,00



Drücker EDELSTAHL matt
Rosette EDELSTAHL matt



Drücker EDELSTAHL poliert
Rosette EDELSTAHL poliert



Drücker PVD Messinggelb
Rosette PVD Messinggelb

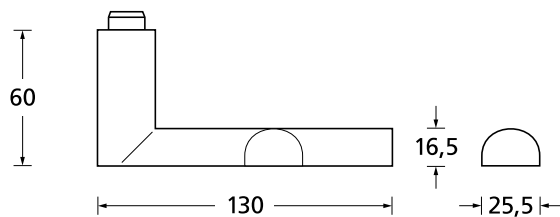



Pullbloc® 3.0 Kugellagertechnik

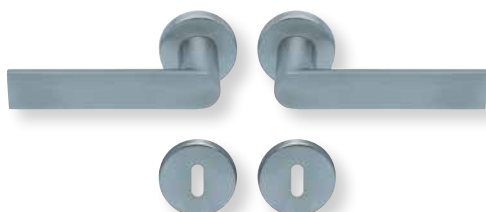

BB - Garnitur EDELSTAHL matt

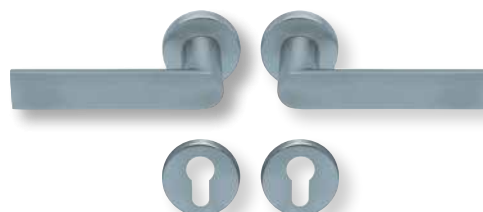

PZ - Garnitur EDELSTAHL matt



WC - Garnitur EDELSTAHL matt
WC - Garnitur rot/weiß Anzeige EDELSTAHL matt
WC - Garnitur rot/grün Anzeige EDELSTAHL matt

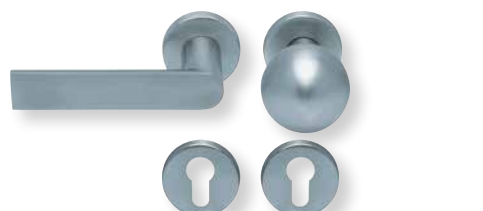

PZ - Wechselgarnitur Knopf gerade EDELSTAHL matt

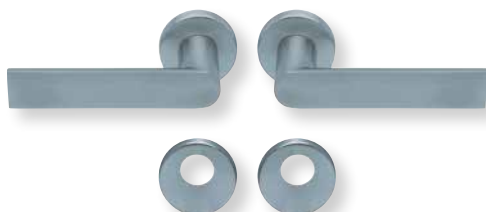

RZ - Garnitur EDELSTAHL matt

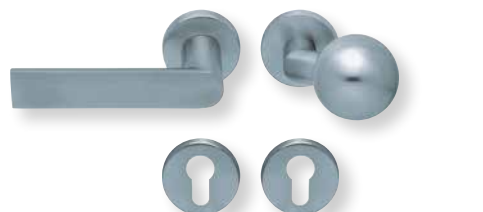

PZ - Wechselgarnitur Knopf gekröpft EDELSTAHL matt

Form 1008 auf Rundrosette

	Edelstahl matt		Edelstahl poliert		PVD Messinggelb	
	€ exkl. MwSt.		€ exkl. MwSt.		€ exkl. MwSt.	
Rosettengarnitur						
BB - Garnitur	PB3.0-10080	47,90	PB3.0-P10080	57,90	PB3.0-PVM10080	67,90
PZ - Garnitur	PB3.0-10082	47,90	PB3.0-P10082	57,90	PB3.0-PVM10082	67,90
OS - Garnitur (ohne Schlüsselrosette)	PB3.0-1008OS	43,90	PB3.0-P1008OS	53,90	PB3.0-PVM1008OS	63,90
RZ - Garnitur	PB3.0-10088	47,90	PB3.0-P10088	57,90	PB3.0-PVM10088	67,90
WC - Garnitur	PB3.0-10083	57,90	PB3.0-P10083	67,90	PB3.0-PVM10083	77,90
WC - Garnitur rot/weiß Anz.	PB3.0-100831	61,90	PB3.0-P100831	71,90	PB3.0-PVM100831	81,90
WC - Garnitur rot/grün Anz.	PB3.0-100832	61,90	PB3.0-P100832	71,90	PB3.0-PVM100832	81,90
PZ-WG - Knopf ger. DIN R/L	PB3.0-10085/6	61,90	PB3.0-P10085/6	71,90	PB3.0-PVM10085/6	81,90
PZ-WG - Knopf gekr. DIN R/L	PB3.0-100851/61	65,90	PB3.0-P100851/61	75,90	PB3.0-PVM100851/61	85,90
Drückerpaar						
ohne Rosetten	D10080	25,90	DP10080	33,90	DPVM10080	41,90

Standard-Türstärken: 38 - 42 mm
Aufpreis für Türstärken ab 42 mm: € 5,00

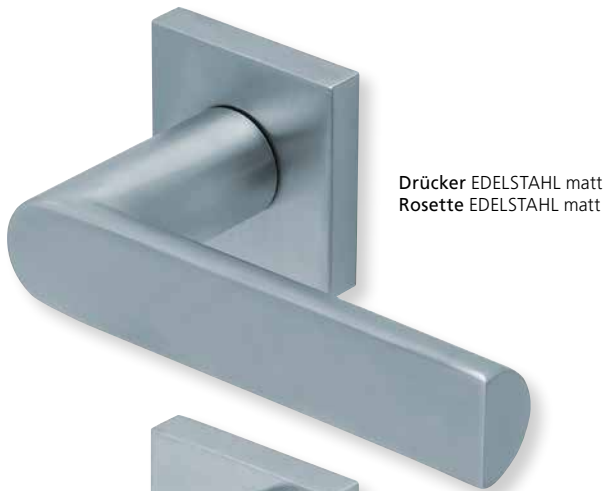

Drücker EDELSTAHL matt
Rosette EDELSTAHL matt



Drücker EDELSTAHL poliert
Rosette EDELSTAHL poliert

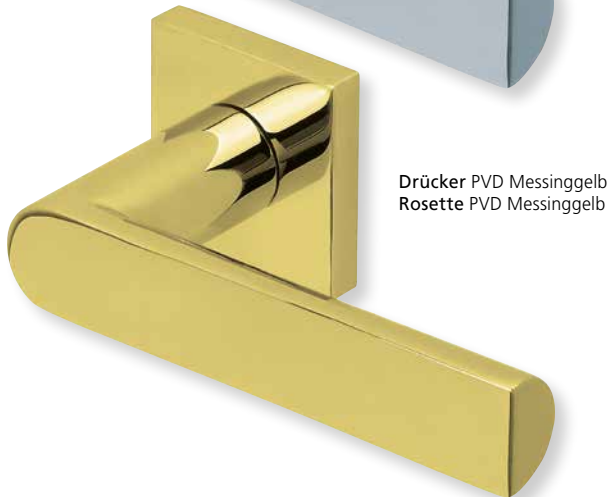

Drücker PVD Messinggelb
Rosette PVD Messinggelb

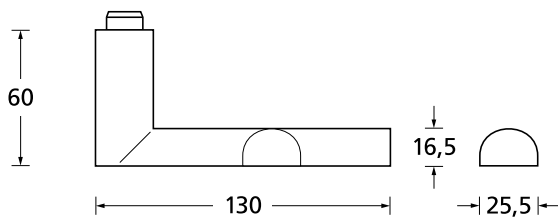



Pullbloc® 3.0 Kugellagertechnik



BB - Garnitur EDELSTAHL poliert



PZ - Garnitur EDELSTAHL poliert



WC - Garnitur EDELSTAHL poliert
WC - Garnitur rot/weiß Anzeige EDELSTAHL poliert
WC - Garnitur rot/grün Anzeige EDELSTAHL poliert



PZ - Wechselgarnitur Knopf gerade EDELSTAHL poliert



RZ - Garnitur EDELSTAHL poliert



PZ - Wechselgarnitur Knopf gekröpft EDELSTAHL poliert

Form 1008 auf Quadratrosette

	Edelstahl matt		Edelstahl poliert		PVD Messinggelb	
	€ exkl. MwSt.		€ exkl. MwSt.		€ exkl. MwSt.	
Rosettengarnitur						
BB - Garnitur	PB3.0-Q10080	53,90	PB3.0-QP10080	63,90	PB3.0-QPVM10080	73,90
PZ - Garnitur	PB3.0-Q10082	53,90	PB3.0-QP10082	63,90	PB3.0-QPVM10082	73,90
OS - Garnitur (ohne Schlüsselrosette)	PB3.0-Q1008OS	49,90	PB3.0-QP1008OS	59,90	PB3.0-QPVM1008OS	69,90
RZ - Garnitur	PB3.0-Q10088	53,90	PB3.0-QP10088	63,90	PB3.0-QPVM10088	73,90
WC - Garnitur	PB3.0-Q10083	63,90	PB3.0-QP10083	73,90	PB3.0-QPVM10083	83,90
WC - Garnitur rot/weiß Anz.	PB3.0-Q100831	67,90	PB3.0-QP100831	77,90	PB3.0-QPVM100831	87,90
WC - Garnitur rot/grün Anz.	PB3.0-Q100832	67,90	PB3.0-QP100832	77,90	PB3.0-QPVM100832	87,90
PZ-WG - Knopf ger. DIN R/L	PB3.0-Q10085/6	67,90	PB3.0-QP10085/6	77,90	PB3.0-QPVM10085/6	87,90
PZ-WG - Knopf gekr. DIN R/L	PB3.0-Q100851/61	71,90	PB3.0-QP100851/61	81,90	PB3.0-QPVM100851/61	91,90
Drückerpaar						
ohne Rosetten	D10080	25,90	DP10080	33,90	DPVM10080	41,90

Standard-Türstärken: 38 - 42 mm
Aufpreis für Türstärken ab 42 mm: € 5,00



Drücker EDELSTAHL matt
Rosette EDELSTAHL matt



Drücker EDELSTAHL poliert
Rosette EDELSTAHL poliert

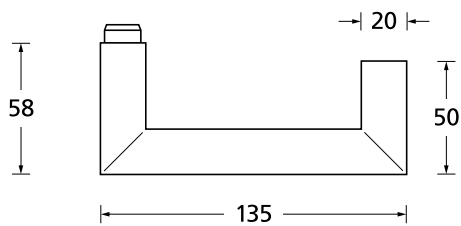



Pullbloc® 3.0 Kugellagertechnik



BB - Garnitur EDELSTAHL matt



PZ - Garnitur EDELSTAHL matt



WC - Garnitur EDELSTAHL matt
WC - Garnitur rot/weiß Anzeige EDELSTAHL matt
WC - Garnitur rot/grün Anzeige EDELSTAHL matt



PZ - Wechselgarnitur Knopf gerade
EDELSTAHL matt



RZ - Garnitur EDELSTAHL matt



PZ - Wechselgarnitur Knopf gekröpft
EDELSTAHL matt

Form 1009 auf Rundrosette

Rosettengarnitur	Edelstahl matt		Edelstahl poliert	
		€ exkl. MwSt.		€ exkl. MwSt.
BB - Garnitur	PB3.0-10090	47,90	PB3.0-P10090	57,90
PZ - Garnitur	PB3.0-10092	47,90	PB3.0-P10092	57,90
OS - Garnitur (ohne Schlüsselrosette)	PB3.0-1009OS	43,90	PB3.0-P1009OS	53,90
RZ - Garnitur	PB3.0-10098	47,90	PB3.0-P10098	57,90
WC - Garnitur	PB3.0-10093	57,90	PB3.0-P10093	67,90
WC - Garnitur rot/weiß Anz.	PB3.0-100931	61,90	PB3.0-P100931	71,90
WC - Garnitur rot/grün Anz.	PB3.0-100932	61,90	PB3.0-P100932	71,90
PZ-WG - Knopf ger. DIN R/L	PB3.0-10095/6	61,90	PB3.0-P10095/6	71,90
PZ-WG - Knopf gekr. DIN R/L	PB3.0-100951/61	65,90	PB3.0-P100951/61	75,90
Drückerpaar				
ohne Rosetten	D10090	25,90	DP10090	33,90

Standard-Türstärken: 38 - 42 mm
Aufpreis für Türstärken ab 42 mm: € 5,00



Drücker EDELSTAHL matt
Rosette EDELSTAHL matt



Drücker EDELSTAHL poliert
Rosette EDELSTAHL poliert

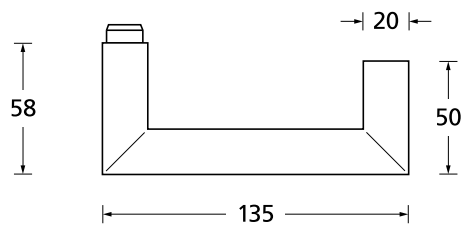



Pullbloc® 3.0 Kugellagertechnik



BB - Garnitur EDELSTAHL poliert



PZ - Garnitur EDELSTAHL poliert



WC - Garnitur EDELSTAHL poliert
WC - Garnitur rot/weiß Anzeige EDELSTAHL poliert
WC - Garnitur rot/grün Anzeige EDELSTAHL poliert



PZ - Wechselgarnitur Knopf gerade EDELSTAHL poliert



RZ - Garnitur EDELSTAHL poliert



PZ - Wechselgarnitur Knopf gekröpft EDELSTAHL poliert

Form 1009 auf Quadratrosette

	Edelstahl matt		Edelstahl poliert	
		€ exkl. MwSt.		€ exkl. MwSt.
Rosettengarnitur				
BB - Garnitur	PB3.0-Q10090	53,90	PB3.0-QP10090	63,90
PZ - Garnitur	PB3.0-Q10092	53,90	PB3.0-QP10092	63,90
OS - Garnitur (ohne Schlüsselrosette)	PB3.0-Q1009OS	49,90	PB3.0-QP1009OS	59,90
RZ - Garnitur	PB3.0-Q10098	53,90	PB3.0-QP10098	63,90
WC - Garnitur	PB3.0-Q10093	63,90	PB3.0-QP10093	73,90
WC - Garnitur rot/weiß Anz.	PB3.0-Q100931	67,90	PB3.0-QP100931	77,90
WC - Garnitur rot/grün Anz.	PB3.0-Q100932	67,90	PB3.0-QP100932	77,90
PZ-WG - Knopf ger. DIN R/L	PB3.0-Q10095/6	67,90	PB3.0-QP10095/6	77,90
PZ-WG - Knopf gekr. DIN R/L	PB3.0-Q100951/61	71,90	PB3.0-QP100951/61	81,90
Drückerpaar				
ohne Rosetten	D10090	25,90	DP10090	33,90

Standard-Türstärken: 38 - 42 mm
Aufpreis für Türstärken ab 42 mm: € 5,00

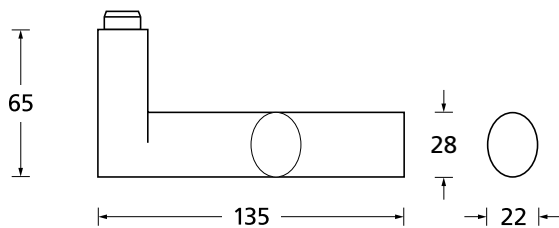
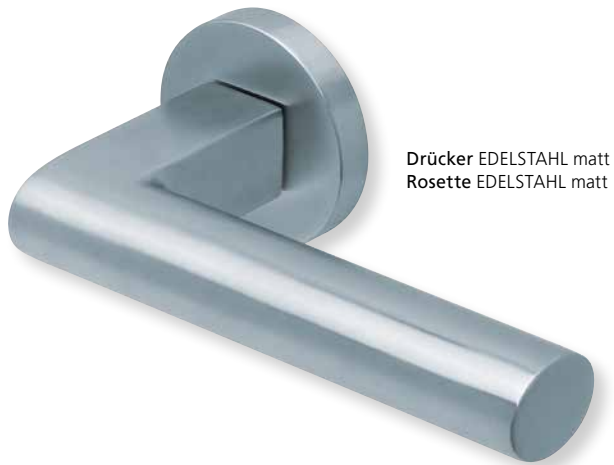



Pullbloc® 3.0 Kugellagertechnik



BB - Garnitur EDELSTAHL matt



PZ - Garnitur EDELSTAHL matt



WC - Garnitur EDELSTAHL matt
WC - Garnitur rot/weiß Anzeige EDELSTAHL matt
WC - Garnitur rot/grün Anzeige EDELSTAHL matt



PZ - Wechselgarnitur Knopf gerade EDELSTAHL matt



RZ - Garnitur EDELSTAHL matt



PZ - Wechselgarnitur Knopf gekröpft EDELSTAHL matt

Form 1011 auf Rundrosette

Edelstahl matt

Rosettengarnitur

		€ exkl. MwSt.
BB - Garnitur	PB3.0-10110	47,90
PZ - Garnitur	PB3.0-10112	47,90
OS - Garnitur (ohne Schlüsselrosette)	PB3.0-10110S	43,90
RZ - Garnitur	PB3.0-10118	47,90
WC - Garnitur	PB3.0-10113	57,90
WC - Garnitur rot/weiß Anz.	PB3.0-101131	61,90
WC - Garnitur rot/grün Anz.	PB3.0-101132	61,90
PZ-WG - Knopf ger. DIN R/L	PB3.0-10115/6	61,90
PZ-WG - Knopf gekr. DIN R/L	PB3.0-101151/61	65,90

Drückerpaar

ohne Rosetten	D10110	25,90
---------------	--------	-------

Standard-Türstärken: 38 - 42 mm
Aufpreis für Türstärken ab 42 mm: € 5,00

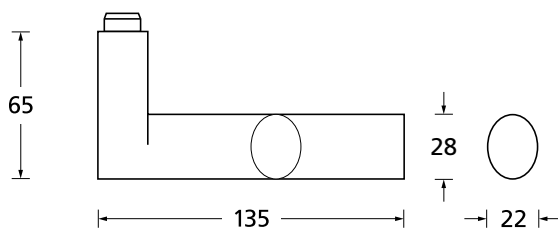
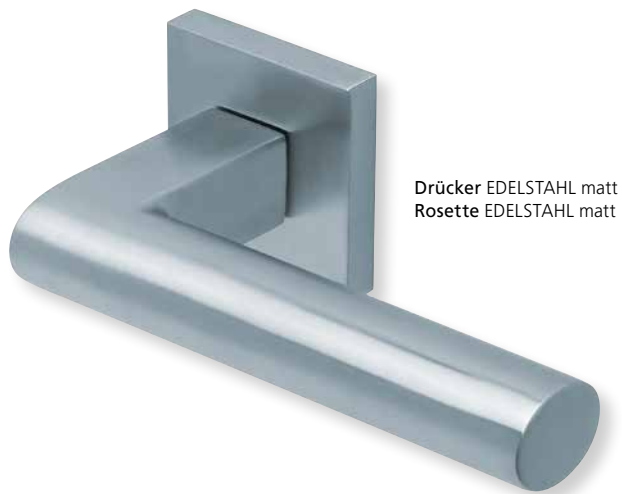



Pullbloc® 3.0 Kugellagertechnik

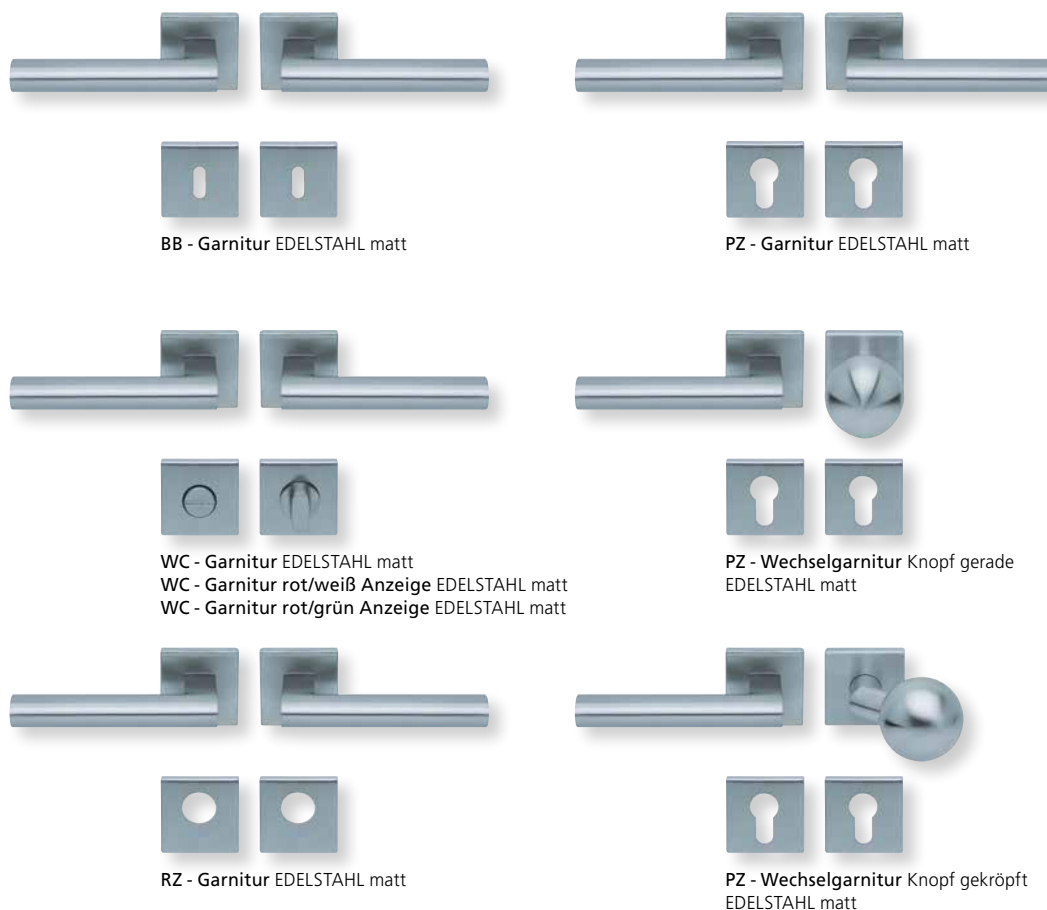

Form 1011 auf Quadratrosette

Edelstahl matt

Rosettengarnitur

		€ exkl. MwSt.
BB - Garnitur	PB3.0-Q10110	53,90
PZ - Garnitur	PB3.0-Q10112	53,90
OS - Garnitur (ohne Schlüsselrosette)	PB3.0-Q10110S	49,90
RZ - Garnitur	PB3.0-Q10118	53,90
WC - Garnitur	PB3.0-Q10113	63,90
WC - Garnitur rot/weiß Anz.	PB3.0-Q101131	67,90
WC - Garnitur rot/grün Anz.	PB3.0-Q101132	67,90
PZ-WG - Knopf ger. DIN R/L	PB3.0-Q10115/6	67,90
PZ-WG - Knopf gekr. DIN R/L	PB3.0-Q101151/61	71,90

Drückerpaar

ohne Rosetten	D10110	25,90
---------------	--------	-------

Standard-Türstärken: 38 - 42 mm
 Aufpreis für Türstärken ab 42 mm: € 5,00

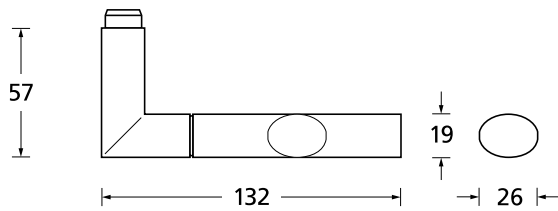



Pullbloc® 3.0 Kugellagertechnik



BB - Garnitur EDELSTAHL matt



PZ - Garnitur EDELSTAHL matt



WC - Garnitur EDELSTAHL matt
WC - Garnitur rot/weiß Anzeige EDELSTAHL matt
WC - Garnitur rot/grün Anzeige EDELSTAHL matt



PZ - Wechselgarnitur Knopf gerade EDELSTAHL matt



RZ - Garnitur EDELSTAHL matt



PZ - Wechselgarnitur Knopf gekröpft EDELSTAHL matt

Form 1012 auf Rundrosette

Edelstahl matt

Rosettengarnitur

		€ exkl. MwSt.
BB - Garnitur	PB3.0-10120	47,90
PZ - Garnitur	PB3.0-10122	47,90
OS - Garnitur (ohne Schlüsselrosette)	PB3.0-10120S	43,90
RZ - Garnitur	PB3.0-10128	47,90
WC - Garnitur	PB3.0-10123	57,90
WC - Garnitur rot/weiß Anz.	PB3.0-101231	61,90
WC - Garnitur rot/grün Anz.	PB3.0-101232	61,90
PZ-WG - Knopf ger. DIN R/L	PB3.0-10125/6	61,90
PZ-WG - Knopf gekr. DIN R/L	PB3.0-101251/61	65,90

Drückerpaar

ohne Rosetten	D10120	25,90
---------------	--------	-------

Standard-Türstärken: 38 - 42 mm
Aufpreis für Türstärken ab 42 mm: € 5,00



Drücker EDELSTAHL matt
Rosette EDELSTAHL matt

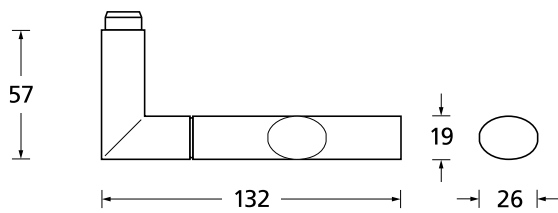



Pullbloc® 3.0 Kugellagertechnik



BB - Garnitur EDELSTAHL matt



PZ - Garnitur EDELSTAHL matt



WC - Garnitur EDELSTAHL matt
 WC - Garnitur rot/weiß Anzeige EDELSTAHL matt
 WC - Garnitur rot/grün Anzeige EDELSTAHL matt



PZ - Wechselgarnitur Knopf gerade EDELSTAHL matt



RZ - Garnitur EDELSTAHL matt



PZ - Wechselgarnitur Knopf gekröpft EDELSTAHL matt

Form 1012 auf Quadratrosette

Edelstahl matt

Rosettengarnitur

		€ exkl. MwSt.
BB - Garnitur	PB3.0-Q10120	53,90
PZ - Garnitur	PB3.0-Q10122	53,90
OS - Garnitur (ohne Schlüsselrosette)	PB3.0-Q10120S	49,90
RZ - Garnitur	PB3.0-Q10128	53,90
WC - Garnitur	PB3.0-Q10123	63,90
WC - Garnitur rot/weiß Anz.	PB3.0-Q101231	67,90
WC - Garnitur rot/grün Anz.	PB3.0-Q101232	67,90
PZ-WG - Knopf ger. DIN R/L	PB3.0-Q10125/6	67,90
PZ-WG - Knopf gekr. DIN R/L	PB3.0-Q101251/61	71,90

Drückerpaar

ohne Rosetten	D10120	25,90
---------------	--------	-------

Standard-Türstärken: 38 - 42 mm
 Aufpreis für Türstärken ab 42 mm: € 5,00



Drücker EDELSTAHL poliert/EDELSTAHL matt
Rosette EDELSTAHL matt



Drücker EDELSTAHL poliert/EDELSTAHL matt
Rosette EDELSTAHL poliert

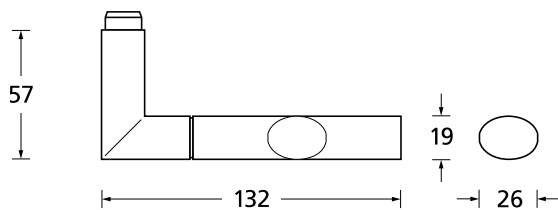



Pullbloc® 3.0 Kugellagertechnik



BB - Garnitur EDELSTAHL poliert



PZ - Garnitur EDELSTAHL poliert



WC - Garnitur EDELSTAHL poliert
WC - Garnitur rot/weiß Anzeige EDELSTAHL poliert
WC - Garnitur rot/grün Anzeige EDELSTAHL poliert



PZ - Wechselgarnitur Knopf gerade EDELSTAHL poliert



RZ - Garnitur EDELSTAHL poliert



PZ - Wechselgarnitur Knopf gekröpft EDELSTAHL poliert

Form 1212 auf Rundrosette

	Edelstahl matt		Edelstahl poliert	
	€ exkl. MwSt.		€ exkl. MwSt.	
Rosettengarnitur				
BB - Garnitur	PB3.0-12120	53,90	PB3.0-P12120	59,90
PZ - Garnitur	PB3.0-12122	53,90	PB3.0-P12122	59,90
OS - Garnitur (ohne Schlüsselrosette)	PB3.0-12120S	49,90	PB3.0-P12120S	55,90
RZ - Garnitur	PB3.0-12128	53,90	PB3.0-P12128	59,90
WC - Garnitur	PB3.0-12123	63,90	PB3.0-P12123	69,90
WC - Garnitur rot/weiß Anz.	PB3.0-121231	67,90	PB3.0-P121231	73,90
WC - Garnitur rot/grün Anz.	PB3.0-121232	67,90	PB3.0-P121232	73,90
PZ-WG - Knopf ger. DIN R/L	PB3.0-12125/6	67,90	PB3.0-P12125/6	73,90
PZ-WG - Knopf gekr. DIN R/L	PB3.0-121251/61	71,90	PB3.0-P121251/61	77,90
Drückerpaar				
ohne Rosetten	D12120	29,90	D12120	29,90

Standard-Türstärken: 38 - 42 mm
Aufpreis für Türstärken ab 42 mm: € 5,00



Drücker EDELSTAHL poliert/EDELSTAHL matt
Rosette EDELSTAHL matt



Drücker EDELSTAHL poliert/EDELSTAHL matt
Rosette EDELSTAHL poliert

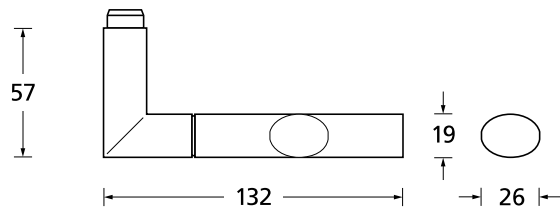



Pullbloc® 3.0 Kugellagertechnik



BB - Garnitur EDELSTAHL poliert



PZ - Garnitur EDELSTAHL poliert



WC - Garnitur EDELSTAHL poliert
WC - Garnitur rot/weiß Anzeige EDELSTAHL poliert
WC - Garnitur rot/grün Anzeige EDELSTAHL poliert



PZ - Wechselgarnitur Knopf gerade EDELSTAHL poliert



RZ - Garnitur EDELSTAHL poliert



PZ - Wechselgarnitur Knopf gekröpft EDELSTAHL poliert

Form 1212 auf Quadratrosette

	Edelstahl matt		Edelstahl poliert	
	€ exkl. MwSt.		€ exkl. MwSt.	
Rosettengarnitur				
BB - Garnitur	PB3.0-Q12120	59,90	PB3.0-QP12120	65,90
PZ - Garnitur	PB3.0-Q12122	59,90	PB3.0-QP12122	65,90
OS - Garnitur (ohne Schlüsselrosette)	PB3.0-Q12120S	55,90	PB3.0-QP12120S	61,90
RZ - Garnitur	PB3.0-Q12128	59,90	PB3.0-QP12128	65,90
WC - Garnitur	PB3.0-Q12123	69,90	PB3.0-QP12123	75,90
WC - Garnitur rot/weiß Anz.	PB3.0-Q121231	73,90	PB3.0-QP121231	79,90
WC - Garnitur rot/grün Anz.	PB3.0-Q121232	73,90	PB3.0-QP121232	79,90
PZ-WG - Knopf ger. DIN R/L	PB3.0-Q12125/6	73,90	PB3.0-QP12125/6	79,90
PZ-WG - Knopf gekr. DIN R/L	PB3.0-Q121251/61	77,90	PB3.0-QP121251/61	83,90
Drückerpaar				
ohne Rosetten	D12120	29,90	D12120	29,90

Standard-Türstärken: 38 - 42 mm
Aufpreis für Türstärken ab 42 mm: € 5,00

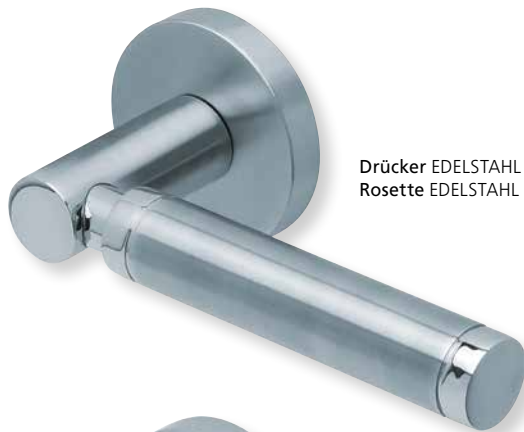

Drücker EDELSTAHL poliert/EDELSTAHL matt
Rosette EDELSTAHL matt



Drücker EDELSTAHL poliert/EDELSTAHL matt
Rosette EDELSTAHL poliert

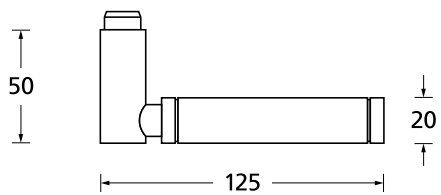



Pullbloc® 3.0 Kugellagertechnik



BB - Garnitur EDELSTAHL poliert



PZ - Garnitur EDELSTAHL poliert



WC - Garnitur EDELSTAHL poliert
WC - Garnitur rot/weiß Anzeige EDELSTAHL poliert
WC - Garnitur rot/grün Anzeige EDELSTAHL poliert



PZ - Wechselgarnitur Knopf gerade EDELSTAHL poliert



RZ - Garnitur EDELSTAHL poliert



PZ - Wechselgarnitur Knopf gekröpft EDELSTAHL poliert

Form 1013 auf Rundrosette

Rosettengarnitur	Edelstahl matt		Edelstahl poliert	
		€ exkl. MwSt.		€ exkl. MwSt.
BB - Garnitur	PB3.0-10130	53,90	PB3.0-P10130	59,90
PZ - Garnitur	PB3.0-10132	53,90	PB3.0-P10132	59,90
OS - Garnitur (ohne Schlüsselrosette)	PB3.0-10130S	49,90	PB3.0-P10130S	55,90
RZ - Garnitur	PB3.0-10138	53,90	PB3.0-P10138	59,90
WC - Garnitur	PB3.0-10133	63,90	PB3.0-P10133	69,90
WC - Garnitur rot/weiß Anz.	PB3.0-101331	68,90	PB3.0-P101331	73,90
WC - Garnitur rot/grün Anz.	PB3.0-101332	68,90	PB3.0-P101332	73,90
PZ-WG - Knopf ger. DIN R/L	PB3.0-10135/6	68,90	PB3.0-P10135/6	73,90
PZ-WG - Knopf gekr. DIN R/L	PB3.0-101351/61	71,90	PB3.0-P101351/61	77,90
Drückerpaar				
ohne Rosetten	D10130	29,90	D10130	29,90

Standard-Türstärken: 38 - 42 mm
Aufpreis für Türstärken ab 42 mm: € 5,00

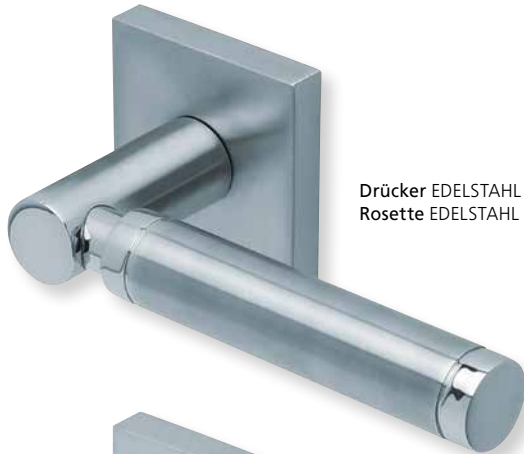

Drücker EDELSTAHL poliert/EDELSTAHL matt
Rosette EDELSTAHL matt

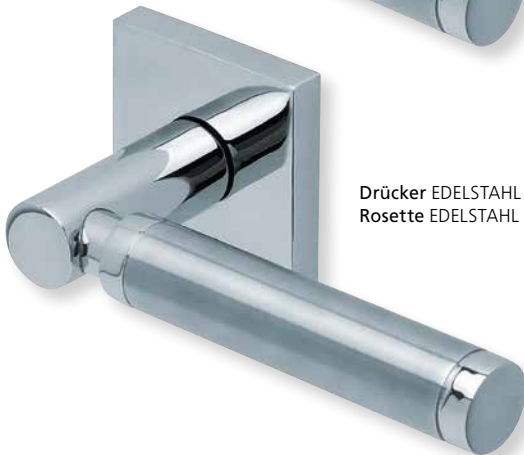

Drücker EDELSTAHL poliert/EDELSTAHL matt
Rosette EDELSTAHL poliert

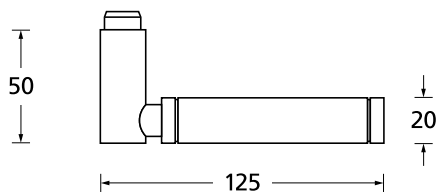



Pullbloc® 3.0 Kugellagertechnik



BB - Garnitur EDELSTAHL poliert



PZ - Garnitur EDELSTAHL poliert



WC - Garnitur EDELSTAHL poliert
WC - Garnitur rot/weiß Anzeige EDELSTAHL poliert
WC - Garnitur rot/grün Anzeige EDELSTAHL poliert



PZ - Wechselgarnitur Knopf gerade EDELSTAHL poliert



RZ - Garnitur EDELSTAHL poliert



PZ - Wechselgarnitur Knopf gekröpft EDELSTAHL poliert

Form 1013 auf Quadratrosette

	Edelstahl matt		Edelstahl poliert	
		€ exkl. MwSt.		€ exkl. MwSt.
Rosettengarnitur				
BB - Garnitur	PB3.0-Q10130	59,90	PB3.0-QP10130	65,90
PZ - Garnitur	PB3.0-Q10132	59,90	PB3.0-QP10132	65,90
OS - Garnitur (ohne Schlüsselrosette)	PB3.0-Q10130S	55,90	PB3.0-QP10130S	61,90
RZ - Garnitur	PB3.0-Q10138	59,90	PB3.0-QP10138	65,90
WC - Garnitur	PB3.0-Q10133	69,90	PB3.0-QP10133	75,90
WC - Garnitur rot/weiß Anz.	PB3.0-Q101331	73,90	PB3.0-QP101331	79,90
WC - Garnitur rot/grün Anz.	PB3.0-Q101332	73,90	PB3.0-QP101332	79,90
PZ-WG - Knopf ger. DIN R/L	PB3.0-Q10135/6	73,90	PB3.0-QP10135/6	79,90
PZ-WG - Knopf gekr. DIN R/L	PB3.0-Q101351/61	77,90	PB3.0-QP101351/61	83,90
Drückerpaar				
ohne Rosetten	D10130	29,90	D10130	29,90

Standard-Türstärken: 38 - 42 mm
Aufpreis für Türstärken ab 42 mm: € 5,00



Drücker EDELSTAHL matt
Rosette EDELSTAHL matt



Drücker EDELSTAHL poliert
Rosette EDELSTAHL poliert



Drücker PVD Messinggelb
Rosette PVD Messinggelb

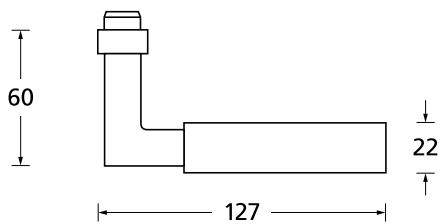



Pullbloc® 3.0 Kugellagertechnik



BB - Garnitur EDELSTAHL matt



PZ - Garnitur EDELSTAHL matt



WC - Garnitur EDELSTAHL matt
WC - Garnitur rot/weiß Anzeige EDELSTAHL matt
WC - Garnitur rot/grün Anzeige EDELSTAHL matt

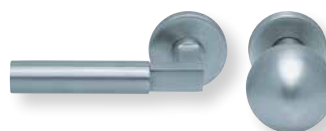

PZ - Wechselgarnitur Knopf gerade
EDELSTAHL matt



RZ - Garnitur EDELSTAHL matt

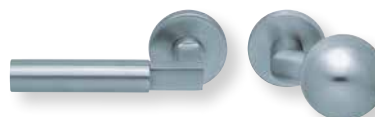

PZ - Wechselgarnitur Knopf gekröpft
EDELSTAHL matt

Form 1016 auf Rundrosette

	Edelstahl matt		Edelstahl poliert		PVD Messinggelb	
	€ exkl. MwSt.		€ exkl. MwSt.		€ exkl. MwSt.	
Rosettengarnitur						
BB - Garnitur	PB3.0-10160	59,90	PB3.0-P10160	69,90	PB3.0-PVM10160	79,90
PZ - Garnitur	PB3.0-10162	59,90	PB3.0-P10162	69,90	PB3.0-PVM10162	79,90
OS - Garnitur (ohne Schlüsselrosette)	PB3.0-1016OS	55,90	PB3.0-P1016OS	65,90	PB3.0-PVM1016OS	75,90
RZ - Garnitur	PB3.0-10168	59,90	PB3.0-P10168	69,90	PB3.0-PVM10168	79,90
WC - Garnitur	PB3.0-10163	69,90	PB3.0-P10163	79,90	PB3.0-PVM10163	89,90
WC - Garnitur rot/weiß Anz.	PB3.0-101631	73,90	PB3.0-P101631	83,90	PB3.0-PVM101631	93,90
WC - Garnitur rot/grün Anz.	PB3.0-101632	73,90	PB3.0-P101632	83,90	PB3.0-PVM101632	93,90
PZ-WG - Knopf ger. DIN R/L	PB3.0-10165/6	73,90	PB3.0-P10165/6	83,90	PB3.0-PVM10165/6	93,90
PZ-WG - Knopf gekr. DIN R/L	PB3.0-101651/61	77,90	PB3.0-P101651/61	87,90	PB3.0-PVM101651/61	97,90
Drückerpaar						
ohne Rosetten	D101601	33,90	DP101601	41,90	DPVM101601	49,90

Standard-Türstärken: 38 - 42 mm
Aufpreis für Türstärken ab 42 mm: € 5,00

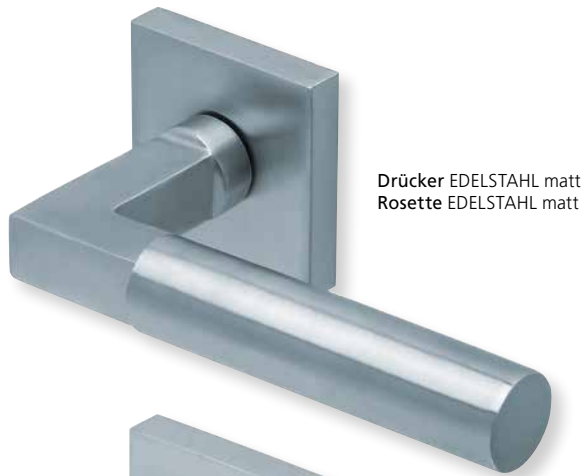

Drücker EDELSTAHL matt
Rosette EDELSTAHL matt



Drücker EDELSTAHL poliert
Rosette EDELSTAHL poliert

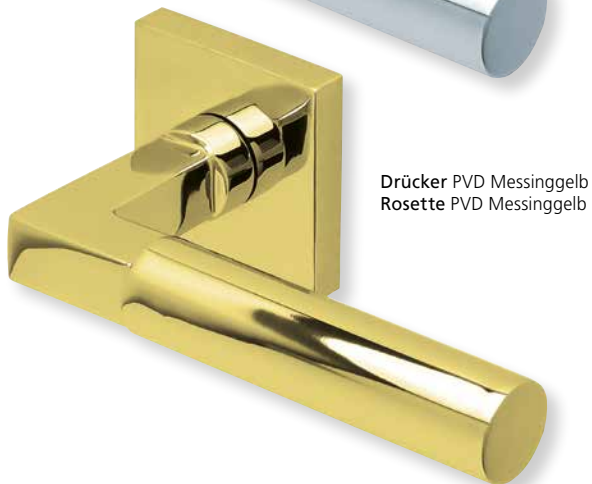

Drücker PVD Messinggelb
Rosette PVD Messinggelb

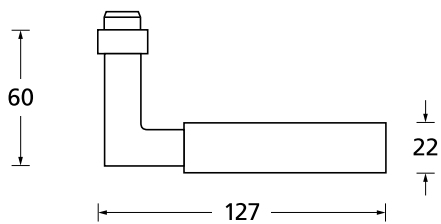



Pullbloc® 3.0 Kugellagertechnik



BB - Garnitur EDELSTAHL poliert



PZ - Garnitur EDELSTAHL poliert



WC - Garnitur EDELSTAHL poliert
WC - Garnitur rot/weiß Anzeige EDELSTAHL poliert
WC - Garnitur rot/grün Anzeige EDELSTAHL poliert



PZ - Wechselgarnitur Knopf gerade EDELSTAHL poliert



RZ - Garnitur EDELSTAHL poliert



PZ - Wechselgarnitur Knopf gekröpft EDELSTAHL poliert

Form 1016 auf Quadratrosette

	Edelstahl matt		Edelstahl poliert		PVD Messinggelb	
	€ exkl. MwSt.		€ exkl. MwSt.		€ exkl. MwSt.	
Rosettengarnitur						
BB - Garnitur	PB3.0-Q10160	65,90	PB3.0-QP10160	75,90	PB3.0-QPVM10160	85,90
PZ - Garnitur	PB3.0-Q10162	65,90	PB3.0-QP10162	75,90	PB3.0-QPVM10162	85,90
OS - Garnitur (ohne Schlüsselrosette)	PB3.0-Q10160S	61,90	PB3.0-QP10160S	71,90	PB3.0-QPVM10160S	81,90
RZ - Garnitur	PB3.0-Q10168	65,90	PB3.0-QP10168	75,90	PB3.0-QPVM10168	85,90
WC - Garnitur	PB3.0-Q10163	75,90	PB3.0-QP10163	85,90	PB3.0-QPVM10163	95,90
WC - Garnitur rot/weiß Anz.	PB3.0-Q101631	79,90	PB3.0-QP101631	89,90	PB3.0-QPVM101631	99,90
WC - Garnitur rot/grün Anz.	PB3.0-Q101632	79,90	PB3.0-QP101632	89,90	PB3.0-QPVM101632	99,90
PZ-WG - Knopf ger. DIN R/L	PB3.0-Q10165/6	79,90	PB3.0-QP10165/6	89,90	PB3.0-QPVM10165/6	99,90
PZ-WG - Knopf gekr. DIN R/L	PB3.0-Q101651/61	83,90	PB3.0-QP101651/61	93,90	PB3.0-QPVM101651/61	103,90
Drückerpaar						
ohne Rosetten	D101601	33,90	DP101601	41,90	DPVM101601	49,90

Standard-Türstärken: 38 - 42 mm
Aufpreis für Türstärken ab 42 mm: € 5,00



Drücker EDELSTAHL matt
Rosette EDELSTAHL matt



Drücker EDELSTAHL poliert
Rosette EDELSTAHL poliert



Drücker PVD Messinggelb
Rosette PVD Messinggelb

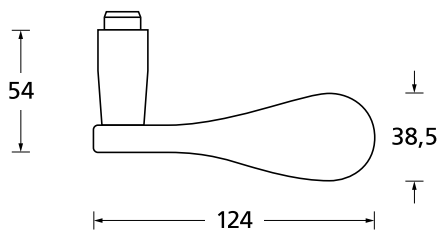



Pullbloc® 3.0 Kugellagertechnik

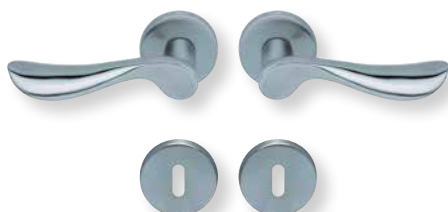

BB - Garnitur EDELSTAHL matt

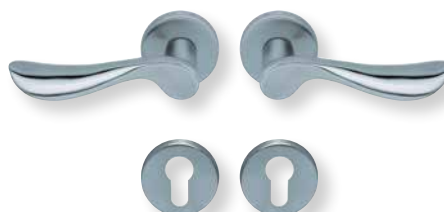

PZ - Garnitur EDELSTAHL matt



WC - Garnitur EDELSTAHL matt
WC - Garnitur rot/weiß Anzeige EDELSTAHL matt
WC - Garnitur rot/grün Anzeige EDELSTAHL matt



PZ - Wechselgarnitur Knopf gerade EDELSTAHL matt



RZ - Garnitur EDELSTAHL matt

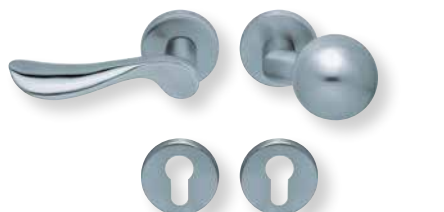

PZ - Wechselgarnitur Knopf gekröpft EDELSTAHL matt

Form 1018 auf Rundrosette

	Edelstahl matt		Edelstahl poliert		PVD Messinggelb	
	€ exkl. MwSt.		€ exkl. MwSt.		€ exkl. MwSt.	
Rosettengarnitur						
BB - Garnitur	PB3.0-10180	53,90	PB3.0-P10180	63,90	PB3.0-PVM10180	73,90
PZ - Garnitur	PB3.0-10182	53,90	PB3.0-P10182	63,90	PB3.0-PVM10182	73,90
OS - Garnitur (ohne Schlüsselrosette)	PB3.0-1018OS	49,90	PB3.0-P1018OS	59,90	PB3.0-PVM1018OS	69,90
RZ - Garnitur	PB3.0-10188	53,90	PB3.0-P10188	63,90	PB3.0-PVM10188	73,90
WC - Garnitur	PB3.0-10183	63,90	PB3.0-P10183	73,90	PB3.0-PVM10183	83,90
WC - Garnitur rot/weiß Anz.	PB3.0-101831	67,90	PB3.0-P101831	77,90	PB3.0-PVM101831	87,90
WC - Garnitur rot/grün Anz.	PB3.0-101832	67,90	PB3.0-P101832	77,90	PB3.0-PVM101832	87,90
PZ-WG - Knopf ger. DIN R/L	PB3.0-10185/6	67,90	PB3.0-P10185/6	77,90	PB3.0-PVM10185/6	87,90
PZ-WG - Knopf gekr. DIN R/L	PB3.0-101851/61	71,90	PB3.0-P101851/61	81,90	PB3.0-PVM101851/61	91,90
Drückerpaar						
ohne Rosetten	D10180	29,90	DP10180	37,90	DPVM10180	45,90

Standard-Türstärken: 38 - 42 mm
Aufpreis für Türstärken ab 42 mm: € 5,00



Drücker EDELSTAHL matt
Rosette EDELSTAHL matt



Drücker EDELSTAHL poliert
Rosette EDELSTAHL poliert



Drücker PVD Messinggelb
Rosette PVD Messinggelb

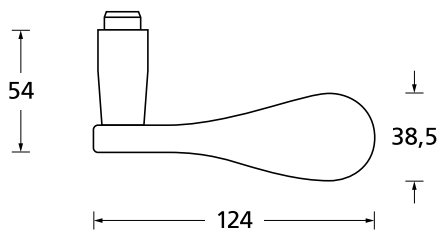



Pullbloc® 3.0 Kugellagertechnik



BB - Garnitur EDELSTAHL poliert



PZ - Garnitur EDELSTAHL poliert



WC - Garnitur EDELSTAHL poliert
WC - Garnitur rot/weiß Anzeige EDELSTAHL poliert
WC - Garnitur rot/grün Anzeige EDELSTAHL poliert



PZ - Wechselgarnitur Knopf gerade EDELSTAHL poliert



RZ - Garnitur EDELSTAHL poliert



PZ - Wechselgarnitur Knopf gekröpft EDELSTAHL poliert

Form 1018 auf Quadratrossette

	Edelstahl matt		Edelstahl poliert		PVD Messinggelb	
	€ exkl. MwSt.		€ exkl. MwSt.		€ exkl. MwSt.	
Rosettengarnitur						
BB - Garnitur	PB3.0-Q10180	59,90	PB3.0-QP10180	69,90	PB3.0-QPVM10180	79,90
PZ - Garnitur	PB3.0-Q10182	59,90	PB3.0-QP10182	69,90	PB3.0-QPVM10182	79,90
OS - Garnitur (ohne Schlüsselrossette)	PB3.0-Q10180S	55,90	PB3.0-QP10180S	65,90	PB3.0-QPVM10180S	75,90
RZ - Garnitur	PB3.0-Q10188	59,90	PB3.0-QP10188	69,90	PB3.0-QPVM10188	79,90
WC - Garnitur	PB3.0-Q10183	69,90	PB3.0-QP10183	79,90	PB3.0-QPVM10183	89,90
WC - Garnitur rot/weiß Anz.	PB3.0-Q101831	73,90	PB3.0-QP101831	83,90	PB3.0-QPVM101831	93,90
WC - Garnitur rot/grün Anz.	PB3.0-Q101832	73,90	PB3.0-QP101832	83,90	PB3.0-QPVM101832	93,90
PZ-WG - Knopf ger. DIN R/L	PB3.0-Q10185/6	73,90	PB3.0-QP10185/6	83,90	PB3.0-QPVM10185/6	93,90
PZ-WG - Knopf gekr. DIN R/L	PB3.0-Q101851/61	77,90	PB3.0-QP101851/61	87,90	PB3.0-QPVM101851/61	97,90
Drückerpaar						
ohne Rosetten	D10180	29,90	DP10180	37,90	DPVM10180	45,90

Standard-Türstärken: 38 - 42 mm
Aufpreis für Türstärken ab 42 mm: € 5,00

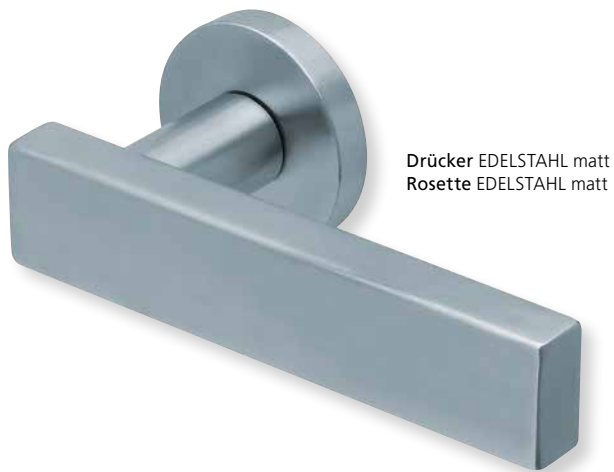

Drücker EDELSTAHL matt
Rosette EDELSTAHL matt

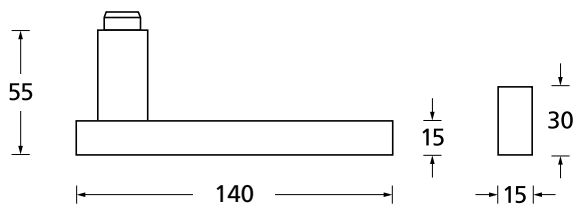



Pullbloc® 3.0 Kugellagertechnik



BB - Garnitur EDELSTAHL matt



PZ - Garnitur EDELSTAHL matt



WC - Garnitur EDELSTAHL matt
WC - Garnitur rot/weiß Anzeige EDELSTAHL matt
WC - Garnitur rot/grün Anzeige EDELSTAHL matt

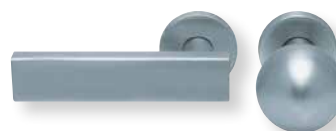

PZ - Wechselgarnitur Knopf gerade EDELSTAHL matt



RZ - Garnitur EDELSTAHL matt



PZ - Wechselgarnitur Knopf gekröpft EDELSTAHL matt

Form 1019 auf Rundrosette

Edelstahl matt

Rosettengarnitur

		€ exkl. MwSt.
BB - Garnitur	PB3.0-10190	47,90
PZ - Garnitur	PB3.0-10192	47,90
OS - Garnitur (ohne Schlüsselrosette)	PB3.0-10190S	43,90
RZ - Garnitur	PB3.0-10198	47,90
WC - Garnitur	PB3.0-10193	57,90
WC - Garnitur rot/weiß Anz.	PB3.0-101931	61,90
WC - Garnitur rot/grün Anz.	PB3.0-101932	61,90
PZ-WG - Knopf ger. DIN R/L	PB3.0-10195/6	61,90
PZ-WG - Knopf gekr. DIN R/L	PB3.0-101951/61	66,90

Drückerpaar

ohne Rosetten	D10190	25,90
---------------	--------	-------

Standard-Türstärken: 38 - 42 mm
Aufpreis für Türstärken ab 42 mm: € 5,00

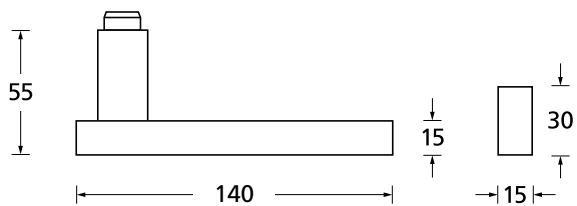
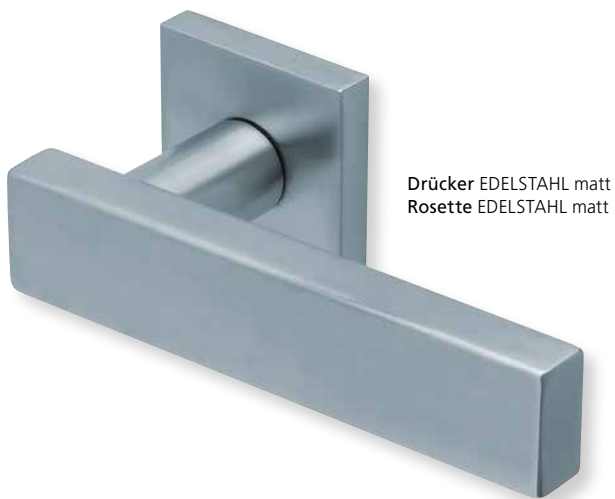



Pullbloc® 3.0 Kugellagertechnik



BB - Garnitur EDELSTAHL matt



PZ - Garnitur EDELSTAHL matt



WC - Garnitur EDELSTAHL matt
WC - Garnitur rot/weiß Anzeige EDELSTAHL matt
WC - Garnitur rot/grün Anzeige EDELSTAHL matt



PZ - Wechselgarnitur Knopf gerade
EDELSTAHL matt



RZ - Garnitur EDELSTAHL matt



PZ - Wechselgarnitur Knopf gekröpft
EDELSTAHL matt

Form 1019 auf Quadratrosette

Edelstahl matt

Rosettengarnitur

		€ exkl. MwSt.
BB - Garnitur	PB3.0-Q10190	53,90
PZ - Garnitur	PB3.0-Q10192	53,90
OS - Garnitur (ohne Schlüsselrosette)	PB3.0-Q10190S	49,90
RZ - Garnitur	PB3.0-Q10198	53,90
WC - Garnitur	PB3.0-Q10193	63,90
WC - Garnitur rot/weiß Anz.	PB3.0-Q101931	67,90
WC - Garnitur rot/grün Anz.	PB3.0-Q101932	67,90
PZ-WG - Knopf ger. DIN R/L	PB3.0-Q10195/6	67,90
PZ-WG - Knopf gekr. DIN R/L	PB3.0-Q101951/61	71,90

Drückerpaar

ohne Rosetten	D10190	25,90
---------------	--------	-------

Standard-Türstärken: 38 - 42 mm
Aufpreis für Türstärken ab 42 mm: € 5,00



Drücker EDELSTAHL matt
Rosette EDELSTAHL matt



Drücker EDELSTAHL poliert
Rosette EDELSTAHL poliert



Drücker PVD Messinggelb
Rosette PVD Messinggelb

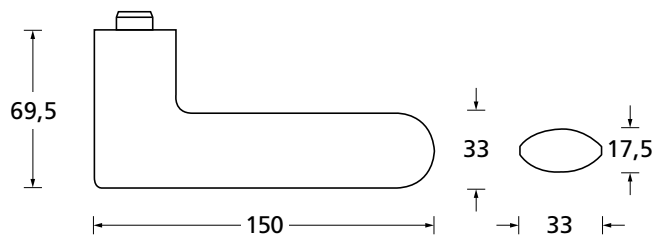



Pullbloc® 3.0 Kugellagertechnik

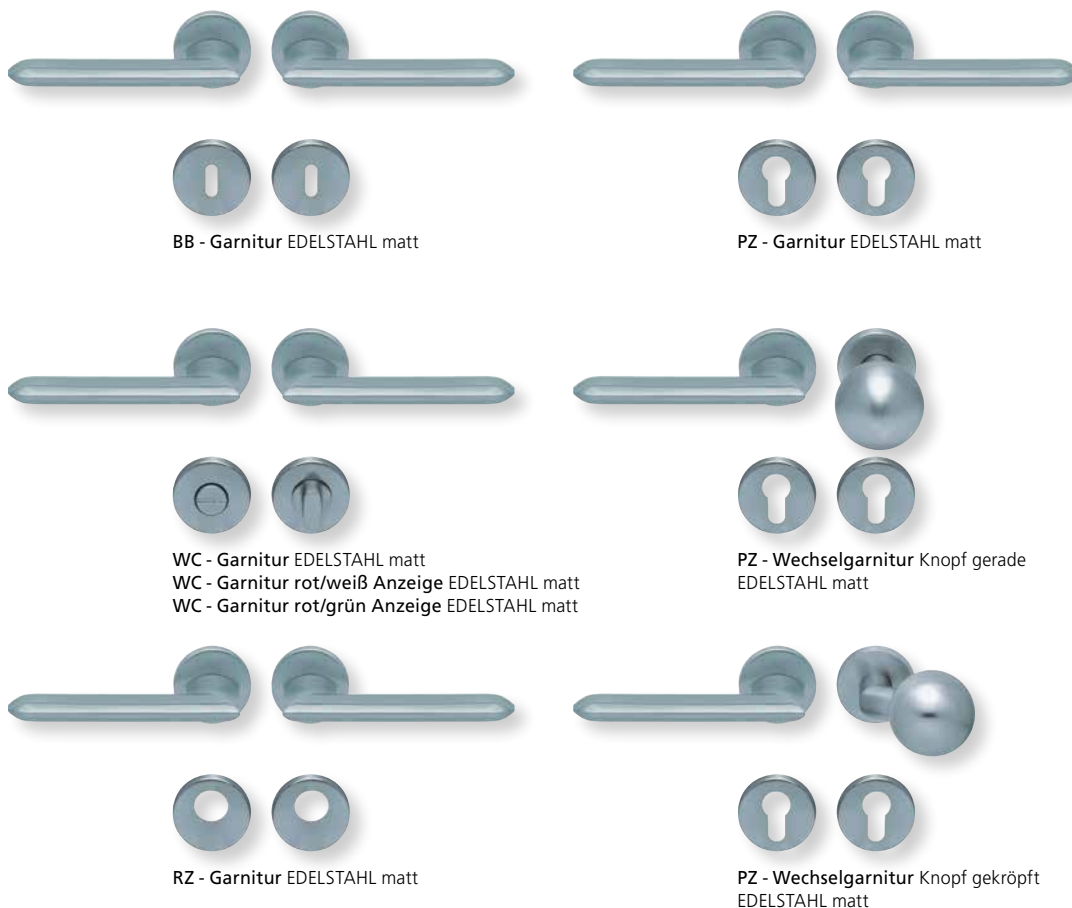

Form 1021 auf Rundrosette

	Edelstahl matt		Edelstahl poliert		PVD Messinggelb	
	€ exkl. MwSt.		€ exkl. MwSt.		€ exkl. MwSt.	
Rosettengarnitur						
BB - Garnitur	PB3.0-10210	59,90	PB3.0-P10210	69,90	PB3.0-PVM10210	79,90
PZ - Garnitur	PB3.0-10212	59,90	PB3.0-P10212	69,90	PB3.0-PVM10212	79,90
OS - Garnitur (ohne Schlüsselrosette)	PB3.0-10210S	55,90	PB3.0-P10210S	65,90	PB3.0-PVM10210S	75,90
RZ - Garnitur	PB3.0-10218	59,90	PB3.0-P10218	69,90	PB3.0-PVM10218	79,90
WC - Garnitur	PB3.0-10213	69,90	PB3.0-P10213	79,90	PB3.0-PVM10213	89,90
WC - Garnitur rot/weiß Anz.	PB3.0-102131	73,90	PB3.0-P102131	83,90	PB3.0-PVM102131	93,90
WC - Garnitur rot/grün Anz.	PB3.0-102132	73,90	PB3.0-P102132	83,90	PB3.0-PVM102132	93,90
PZ-WG - Knopf ger. DIN R/L	PB3.0-10215/6	73,90	PB3.0-P10215/6	83,90	PB3.0-PVM10215/6	93,90
PZ-WG - Knopf gekr. DIN R/L	PB3.0-102151/61	77,90	PB3.0-P102151/61	87,90	PB3.0-PVM102151/61	97,90
Drückerpaar						
ohne Rosetten	D10210	33,90	DP10210	41,90	DPVM10210	49,90

Standard-Türstärken: 38 - 42 mm
 Aufpreis für Türstärken ab 42 mm: € 5,00



Drücker EDELSTAHL matt
Rosette EDELSTAHL matt



Drücker EDELSTAHL poliert
Rosette EDELSTAHL poliert



Drücker PVD Messinggelb
Rosette PVD Messinggelb

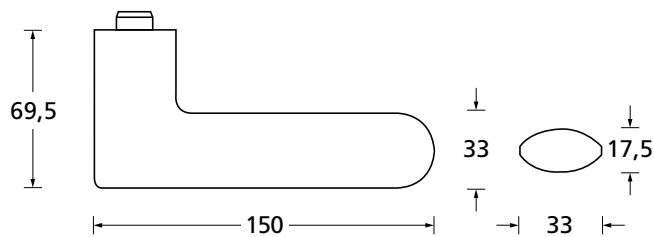



Pullbloc® 3.0 Kugellagertechnik

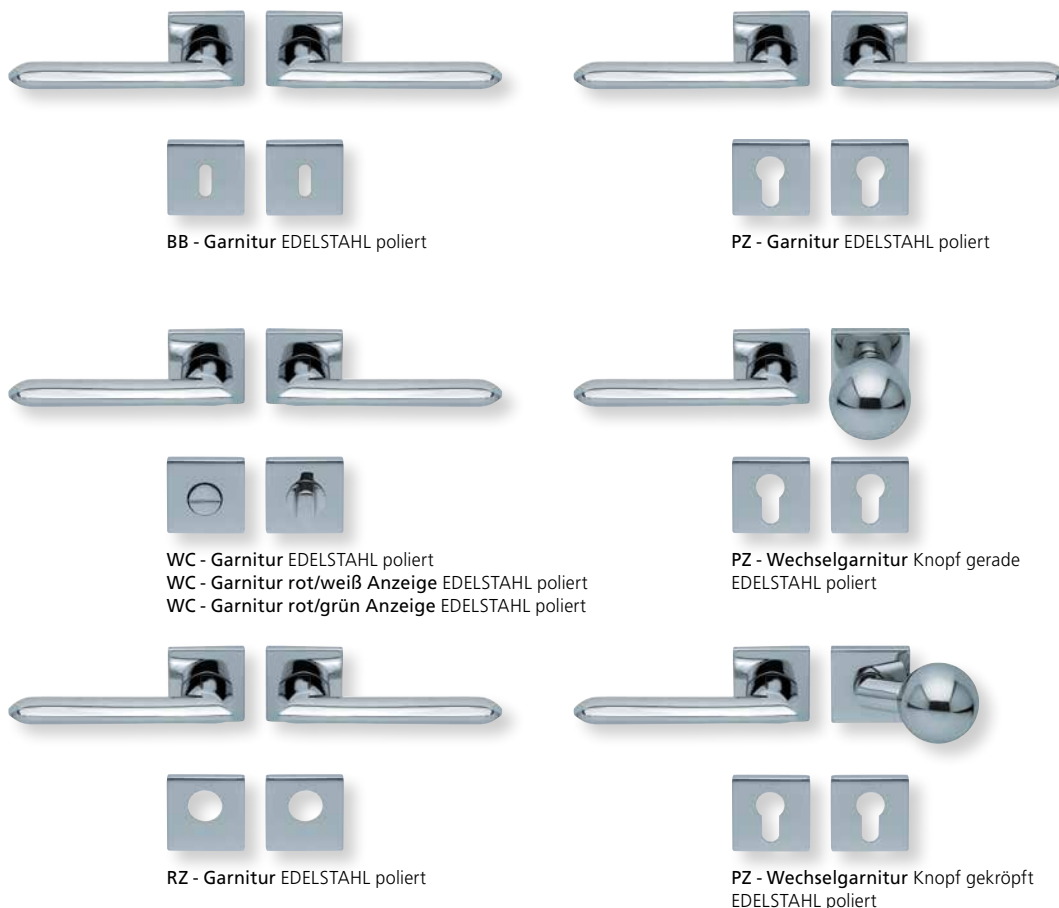

Form 1021 auf Quadratrosette

	Edelstahl matt		Edelstahl poliert		PVD Messinggelb	
	€ exkl. MwSt.		€ exkl. MwSt.		€ exkl. MwSt.	
Rosettengarnitur						
BB - Garnitur	PB3.0-Q10210	65,90	PB3.0-QP10210	75,90	PB3.0-QPVM10210	85,90
PZ - Garnitur	PB3.0-Q10212	65,90	PB3.0-QP10212	75,90	PB3.0-QPVM10212	85,90
OS - Garnitur (ohne Schlüsselrosette)	PB3.0-Q10210S	61,90	PB3.0-QP10210S	71,90	PB3.0-QPVM10210S	81,90
RZ - Garnitur	PB3.0-Q10218	65,90	PB3.0-QP10218	75,90	PB3.0-QPVM10218	85,90
WC - Garnitur	PB3.0-Q10213	75,90	PB3.0-QP10213	85,90	PB3.0-QPVM10213	95,90
WC - Garnitur rot/weiß Anz.	PB3.0-Q102131	79,90	PB3.0-QP102131	89,90	PB3.0-QPVM102131	99,90
WC - Garnitur rot/grün Anz.	PB3.0-Q102132	79,90	PB3.0-QP102132	89,90	PB3.0-QPVM102132	99,90
PZ-WG - Knopf ger. DIN R/L	PB3.0-Q10215/6	79,90	PB3.0-QP10215/6	89,90	PB3.0-QPVM10215/6	99,90
PZ-WG - Knopf gekr. DIN R/L	PB3.0-Q102151/61	83,90	PB3.0-QP102151/61	93,90	PB3.0-QPVM102151/61	103,90
Drückerpaar						
ohne Rosetten	D10210	33,90	DP10210	41,90	DPVM10210	49,90

Standard-Türstärken: 38 - 42 mm
 Aufpreis für Türstärken ab 42 mm: € 5,00



Drücker EDELSTAHL matt
Rosette EDELSTAHL matt



Drücker EDELSTAHL poliert
Rosette EDELSTAHL poliert

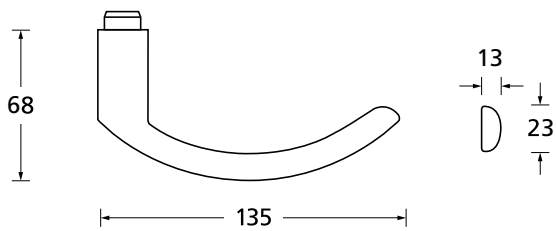



Pullbloc® 3.0 Kugellagertechnik



BB - Garnitur EDELSTAHL matt



PZ - Garnitur EDELSTAHL matt



WC - Garnitur EDELSTAHL matt
WC - Garnitur rot/weiß Anzeige EDELSTAHL matt
WC - Garnitur rot/grün Anzeige EDELSTAHL matt



PZ - Wechselgarnitur Knopf gerade EDELSTAHL matt

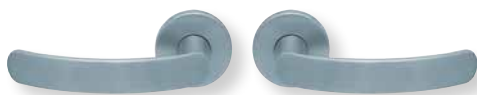

RZ - Garnitur EDELSTAHL matt

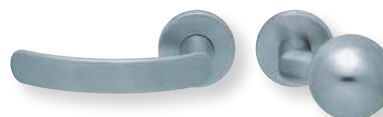

PZ - Wechselgarnitur Knopf gekröpft EDELSTAHL matt

Form 1023 auf Rundrosette

	Edelstahl matt		Edelstahl poliert	
		€ exkl. MwSt.		€ exkl. MwSt.
Rosettengarnitur				
BB - Garnitur	PB3.0-10230	47,90	PB3.0-P10230	57,90
PZ - Garnitur	PB3.0-10232	47,90	PB3.0-P10232	57,90
OS - Garnitur (ohne Schlüsselrosette)	PB3.0-1023OS	43,90	PB3.0-P1023OS	53,90
RZ - Garnitur	PB3.0-10238	47,90	PB3.0-P10238	57,90
WC - Garnitur	PB3.0-10233	57,90	PB3.0-P10233	67,90
WC - Garnitur rot/weiß Anz.	PB3.0-102331	61,90	PB3.0-P102331	71,90
WC - Garnitur rot/grün Anz.	PB3.0-102332	61,90	PB3.0-P102332	71,90
PZ-WG - Knopf ger. DIN R/L	PB3.0-10235/6	61,90	PB3.0-P10235/6	71,90
PZ-WG - Knopf gekr. DIN R/L	PB3.0-102351/61	65,90	PB3.0-P102351/61	75,90
Drückerpaar				
ohne Rosetten	D10230	25,90	DP10230	33,90

Standard-Türstärken: 38 - 42 mm
Aufpreis für Türstärken ab 42 mm: € 5,00



Drücker EDELSTAHL matt
Rosette EDELSTAHL matt



Drücker EDELSTAHL poliert
Rosette EDELSTAHL poliert

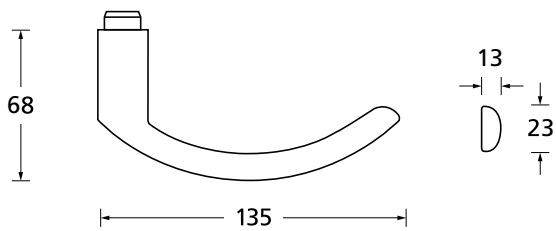



Pullbloc® 3.0 Kugellagertechnik



BB - Garnitur EDELSTAHL poliert



PZ - Garnitur EDELSTAHL poliert



WC - Garnitur EDELSTAHL poliert
WC - Garnitur rot/weiß Anzeige EDELSTAHL poliert
WC - Garnitur rot/grün Anzeige EDELSTAHL poliert



PZ - Wechselgarnitur Knopf gerade EDELSTAHL poliert



RZ - Garnitur EDELSTAHL poliert



PZ - Wechselgarnitur Knopf gekröpft EDELSTAHL poliert

Form 1023 auf Quadratrosette

	Edelstahl matt		Edelstahl poliert	
		€ exkl. MwSt.		€ exkl. MwSt.
Rosettengarnitur				
BB - Garnitur	PB3.0-Q10230	53,90	PB3.0-QP10230	63,90
PZ - Garnitur	PB3.0-Q10232	53,90	PB3.0-QP10232	63,90
OS - Garnitur (ohne Schlüsselrosette)	PB3.0-Q1023OS	49,90	PB3.0-QP1023OS	59,90
RZ - Garnitur	PB3.0-Q10238	53,90	PB3.0-QP10238	63,90
WC - Garnitur	PB3.0-Q10233	63,90	PB3.0-QP10233	73,90
WC - Garnitur rot/weiß Anz.	PB3.0-Q102331	67,90	PB3.0-QP102331	77,90
WC - Garnitur rot/grün Anz.	PB3.0-Q102332	67,90	PB3.0-QP102332	77,90
PZ-WG - Knopf ger. DIN R/L	PB3.0-Q10235/6	67,90	PB3.0-QP10235/6	77,90
PZ-WG - Knopf gekr. DIN R/L	PB3.0-Q102351/61	71,90	PB3.0-QP102351/61	81,90
Drückerpaar				
ohne Rosetten	D10230	25,90	DP10230	33,90

Standard-Türstärken: 38 - 42 mm
Aufpreis für Türstärken ab 42 mm: € 5,00



Drücker EDELSTAHL matt
Rosette EDELSTAHL matt



Drücker EDELSTAHL poliert
Rosette EDELSTAHL poliert



Drücker PVD Messinggelb
Rosette PVD Messinggelb

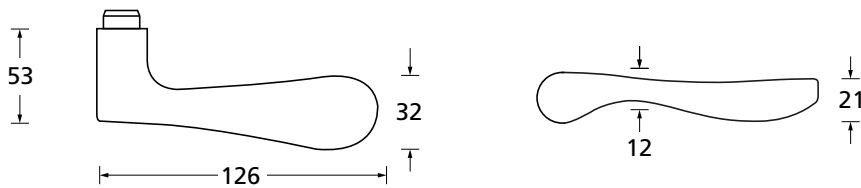



Pullbloc® 3.0 Kugellagertechnik



BB - Garnitur EDELSTAHL matt



PZ - Garnitur EDELSTAHL matt



WC - Garnitur EDELSTAHL matt
WC - Garnitur rot/weiß Anzeige EDELSTAHL matt
WC - Garnitur rot/grün Anzeige EDELSTAHL matt



PZ - Wechselgarnitur Knopf gerade EDELSTAHL matt



RZ - Garnitur EDELSTAHL matt



PZ - Wechselgarnitur Knopf gekröpft EDELSTAHL matt

Form 1024 auf Rundrosette

	Edelstahl matt		Edelstahl poliert		PVD Messinggelb	
	€ exkl. MwSt.		€ exkl. MwSt.		€ exkl. MwSt.	
Rosettengarnitur						
BB - Garnitur	PB3.0-10240	53,90	PB3.0-P10240	63,90	PB3.0-PVM10240	73,90
PZ - Garnitur	PB3.0-10242	53,90	PB3.0-P10242	63,90	PB3.0-PVM10242	73,90
OS - Garnitur (ohne Schlüsselrosette)	PB3.0-1024OS	49,90	PB3.0-P1024OS	59,90	PB3.0-PVM1024OS	69,90
RZ - Garnitur	PB3.0-10248	53,90	PB3.0-P10248	63,90	PB3.0-PVM10248	73,90
WC - Garnitur	PB3.0-10243	63,90	PB3.0-P10243	73,90	PB3.0-PVM10243	83,90
WC - Garnitur rot/weiß Anz.	PB3.0-102431	67,90	PB3.0-P102431	77,90	PB3.0-PVM102431	87,90
WC - Garnitur rot/grün Anz.	PB3.0-102432	67,90	PB3.0-P102432	77,90	PB3.0-PVM102432	87,90
PZ-WG - Knopf ger. DIN R/L	PB3.0-10245/6	67,90	PB3.0-P10245/6	77,90	PB3.0-PVM10245/6	87,90
PZ-WG - Knopf gekr. DIN R/L	PB3.0-102451/61	71,90	PB3.0-P102451/61	81,90	PB3.0-PVM102451/61	91,90
Drückerpaar						
ohne Rosetten	D10240	29,90	DP10240	37,90	DPVM10240	45,90

Standard-Türstärken: 38 - 42 mm
Aufpreis für Türstärken ab 42 mm: € 5,00



Drücker EDELSTAHL matt
Rosette EDELSTAHL matt



Drücker EDELSTAHL poliert
Rosette EDELSTAHL poliert



Drücker PVD Messinggelb
Rosette PVD Messinggelb

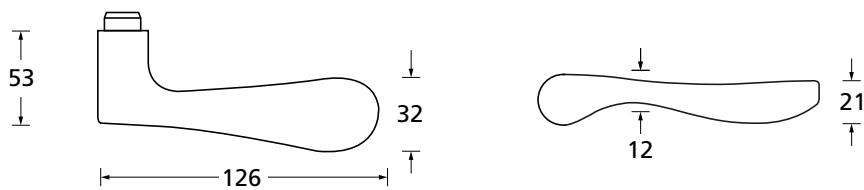



Pullbloc® 3.0 Kugellagertechnik



BB - Garnitur EDELSTAHL poliert



PZ - Garnitur EDELSTAHL poliert



WC - Garnitur EDELSTAHL poliert
WC - Garnitur rot/weiß Anzeige EDELSTAHL poliert
WC - Garnitur rot/grün Anzeige EDELSTAHL poliert



PZ - Wechselgarnitur Knopf gerade EDELSTAHL poliert



RZ - Garnitur EDELSTAHL poliert



PZ - Wechselgarnitur Knopf gekröpft EDELSTAHL poliert

Form 1024 auf Quadratrosette

	Edelstahl matt		Edelstahl poliert		PVD Messinggelb	
		€ exkl. MwSt.		€ exkl. MwSt.		€ exkl. MwSt.
Rosettengarnitur						
BB - Garnitur	PB3.0-Q10240	58,90	PB3.0-QP10240	68,90	PB3.0-QPVM10240	78,90
PZ - Garnitur	PB3.0-Q10242	58,90	PB3.0-QP10242	68,90	PB3.0-QPVM10242	78,90
OS - Garnitur (ohne Schlüsselrosette)	PB3.0-Q10240S	55,90	PB3.0-QP10240S	65,90	PB3.0-QPVM10240S	75,90
RZ - Garnitur	PB3.0-Q10248	59,90	PB3.0-QP10248	69,90	PB3.0-QPVM10248	79,90
WC - Garnitur	PB3.0-Q10243	69,90	PB3.0-QP10243	79,90	PB3.0-QPVM10243	89,90
WC - Garnitur rot/weiß Anz.	PB3.0-Q102431	73,90	PB3.0-QP102431	83,90	PB3.0-QPVM102431	93,90
WC - Garnitur rot/grün Anz.	PB3.0-Q102432	73,90	PB3.0-QP102432	83,90	PB3.0-QPVM102432	93,90
PZ-WG - Knopf ger. DIN R/L	PB3.0-Q10245/6	73,90	PB3.0-QP10245/6	83,90	PB3.0-QPVM10245/6	93,90
PZ-WG - Knopf gekr. DIN R/L	PB3.0-Q102451/61	77,90	PB3.0-QP102451/61	87,90	PB3.0-QPVM102451/61	97,90
Drückerpaar						
ohne Rosetten	D10240	29,90	DP10240	37,90	DPVM10240	45,90

Standard-Türstärken: 38 - 42 mm
Aufpreis für Türstärken ab 42 mm: € 5,00



Drücker EDELSTAHL matt
Rosette EDELSTAHL matt



Drücker EDELSTAHL poliert
Rosette EDELSTAHL poliert

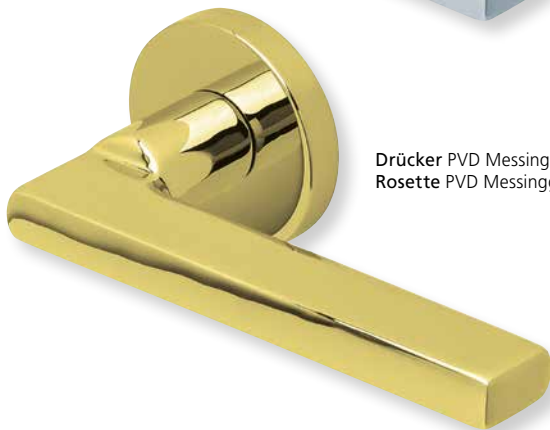

Drücker PVD Messinggelb
Rosette PVD Messinggelb

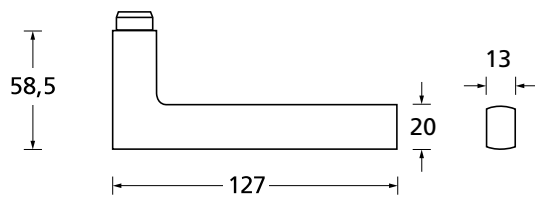



Pullbloc® 3.0 Kugellagertechnik



BB - Garnitur EDELSTAHL matt



PZ - Garnitur EDELSTAHL matt



WC - Garnitur EDELSTAHL matt
WC - Garnitur rot/weiß Anzeige EDELSTAHL matt
WC - Garnitur rot/grün Anzeige EDELSTAHL matt



PZ - Wechselgarnitur Knopf gerade
EDELSTAHL matt



RZ - Garnitur EDELSTAHL matt



PZ - Wechselgarnitur Knopf gekröpft
EDELSTAHL matt

Form 1025 auf Rundrosette

	Edelstahl matt		Edelstahl poliert		PVD Messinggelb	
	€ exkl. MwSt.		€ exkl. MwSt.		€ exkl. MwSt.	
Rosettengarnitur						
BB - Garnitur	PB3.0-10250	53,90	PB3.0-P10250	63,90	PB3.0-PVM10250	73,90
PZ - Garnitur	PB3.0-10252	53,90	PB3.0-P10252	63,90	PB3.0-PVM10252	73,90
OS - Garnitur (ohne Schlüsselrosette)	PB3.0-1025OS	49,90	PB3.0-P1025OS	59,90	PB3.0-PVM1025OS	69,90
RZ - Garnitur	PB3.0-10258	53,90	PB3.0-P10258	63,90	PB3.0-PVM10258	73,90
WC - Garnitur	PB3.0-10253	63,90	PB3.0-P10253	73,90	PB3.0-PVM10253	83,90
WC - Garnitur rot/weiß Anz.	PB3.0-102531	67,90	PB3.0-P102531	77,90	PB3.0-PVM102531	87,90
WC - Garnitur rot/grün Anz.	PB3.0-102532	67,90	PB3.0-P102532	77,90	PB3.0-PVM102532	87,90
PZ-WG - Knopf ger. DIN R/L	PB3.0-10255/6	67,90	PB3.0-P10255/6	77,90	PB3.0-PVM10255/6	87,90
PZ-WG - Knopf gekr. DIN R/L	PB3.0-102551/61	71,90	PB3.0-P102551/61	81,90	PB3.0-PVM102551/61	91,90
Drückerpaar						
ohne Rosetten	D10250	29,90	DP10250	37,90	DPVM10250	45,90

Standard-Türstärken: 38 - 42 mm
Aufpreis für Türstärken ab 42 mm: € 5,00

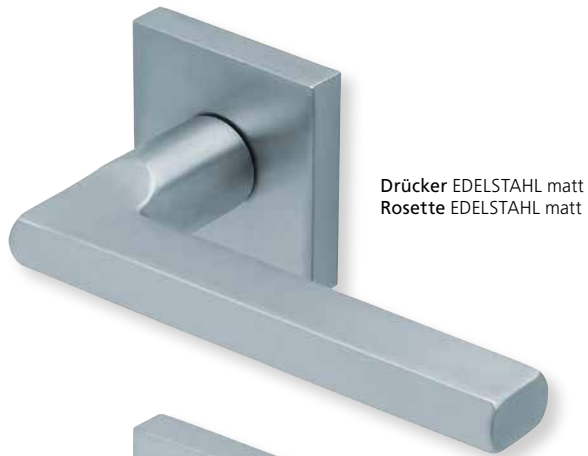

Drücker EDELSTAHL matt
Rosette EDELSTAHL matt



Drücker EDELSTAHL poliert
Rosette EDELSTAHL poliert

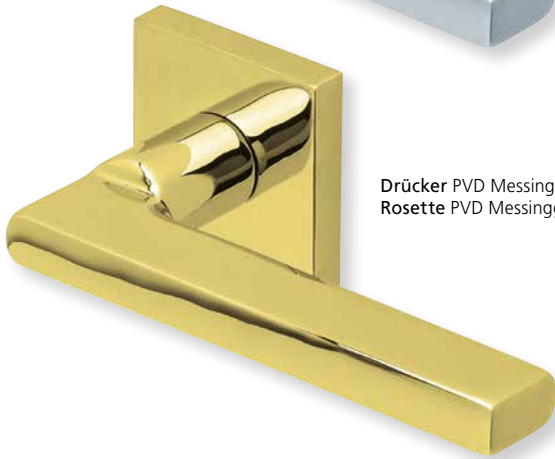

Drücker PVD Messinggelb
Rosette PVD Messinggelb

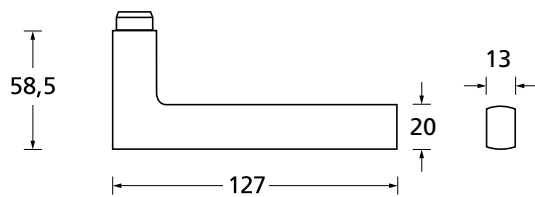



Pullbloc® 3.0 Kugellagertechnik



BB - Garnitur EDELSTAHL poliert



PZ - Garnitur EDELSTAHL poliert



WC - Garnitur EDELSTAHL poliert
WC - Garnitur rot/weiß Anzeige EDELSTAHL poliert
WC - Garnitur rot/grün Anzeige EDELSTAHL poliert



PZ - Wechselgarnitur Knopf gerade
EDELSTAHL poliert



RZ - Garnitur EDELSTAHL poliert



PZ - Wechselgarnitur Knopf gekröpft
EDELSTAHL poliert

Form 1025 auf Quadratrosette

	Edelstahl matt		Edelstahl poliert		PVD Messinggelb	
	€ exkl. MwSt.		€ exkl. MwSt.		€ exkl. MwSt.	
Rosettengarnitur						
BB - Garnitur	PB3.0-Q10250	59,90	PB3.0-QP10250	69,90	PB3.0-QPVM10250	79,90
PZ - Garnitur	PB3.0-Q10252	59,90	PB3.0-QP10252	69,90	PB3.0-QPVM10252	79,90
OS - Garnitur (ohne Schlüsselrosette)	PB3.0-Q10250S	55,90	PB3.0-QP10250S	65,90	PB3.0-QPVM10250S	75,90
RZ - Garnitur	PB3.0-Q10258	59,90	PB3.0-QP10258	69,90	PB3.0-QPVM10258	79,90
WC - Garnitur	PB3.0-Q10253	69,90	PB3.0-QP10253	79,90	PB3.0-QPVM10253	89,90
WC - Garnitur rot/weiß Anz.	PB3.0-Q102531	73,90	PB3.0-QP102531	83,90	PB3.0-QPVM102531	93,90
WC - Garnitur rot/grün Anz.	PB3.0-Q102532	73,90	PB3.0-QP102532	83,90	PB3.0-QPVM102532	93,90
PZ-WG - Knopf ger. DIN R/L	PB3.0-Q10255/6	73,90	PB3.0-QP10255/6	83,90	PB3.0-QPVM10255/6	93,90
PZ-WG - Knopf gekr. DIN R/L	PB3.0-Q102551/61	77,90	PB3.0-QP102551/61	87,90	PB3.0-QPVM102551/61	97,90
Drückerpaar						
ohne Rosetten	D10250	29,90	DP10250	37,90	DPVM10250	45,90

Standard-Türstärken: 38 - 42 mm
Aufpreis für Türstärken ab 42 mm: € 5,00



Drücker EDELSTAHL matt
Rosette EDELSTAHL matt



Drücker EDELSTAHL poliert
Rosette EDELSTAHL poliert



Drücker PVD Messinggelb
Rosette PVD Messinggelb

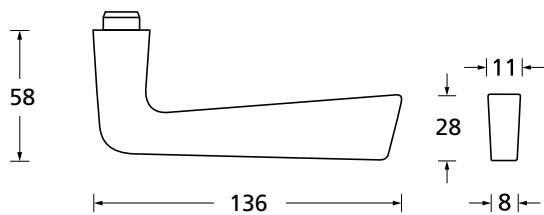



Pullbloc® 3.0 Kugellagertechnik



BB - Garnitur EDELSTAHL matt



PZ - Garnitur EDELSTAHL matt



WC - Garnitur EDELSTAHL matt
WC - Garnitur rot/weiß Anzeige EDELSTAHL matt
WC - Garnitur rot/grün Anzeige EDELSTAHL matt



PZ - Wechselgarnitur Knopf gerade
EDELSTAHL matt



RZ - Garnitur EDELSTAHL matt



PZ - Wechselgarnitur Knopf gekröpft
EDELSTAHL matt

Form 1026 auf Rundrosette

	Edelstahl matt		Edelstahl poliert		PVD Messinggelb	
	€ exkl. MwSt.		€ exkl. MwSt.		€ exkl. MwSt.	
Rosettengarnitur						
BB - Garnitur	PB3.0-10260	53,90	PB3.0-P10260	63,90	PB3.0-PVM10260	73,90
PZ - Garnitur	PB3.0-10262	53,90	PB3.0-P10262	63,90	PB3.0-PVM10262	73,90
OS - Garnitur (ohne Schlüsselrosette)	PB3.0-1026OS	49,90	PB3.0-P1026OS	59,90	PB3.0-PVM1026OS	69,90
RZ - Garnitur	PB3.0-10268	53,90	PB3.0-P10268	63,90	PB3.0-PVM10268	73,90
WC - Garnitur	PB3.0-10263	63,90	PB3.0-P10263	73,90	PB3.0-PVM10263	83,90
WC - Garnitur rot/weiß Anz.	PB3.0-102631	67,90	PB3.0-P102631	77,90	PB3.0-PVM102631	87,90
WC - Garnitur rot/grün Anz.	PB3.0-102632	67,90	PB3.0-P102632	77,90	PB3.0-PVM102632	87,90
PZ-WG - Knopf ger. DIN R/L	PB3.0-10265/6	67,90	PB3.0-P10265/6	77,90	PB3.0-PVM10265/6	87,90
PZ-WG - Knopf gekr. DIN R/L	PB3.0-102651/61	71,90	PB3.0-P102651/61	81,90	PB3.0-PVM102651/61	91,90
Drückerpaar						
ohne Rosetten	D10260	29,90	DP10260	37,90	DPVM10260	45,90

Standard-Türstärken: 38 - 42 mm
Aufpreis für Türstärken ab 42 mm: € 5,00

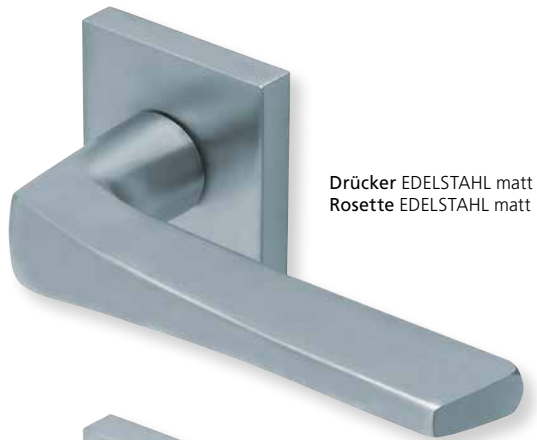

Drücker EDELSTAHL matt
Rosette EDELSTAHL matt



Drücker EDELSTAHL poliert
Rosette EDELSTAHL poliert



Drücker PVD Messinggelb
Rosette PVD Messinggelb

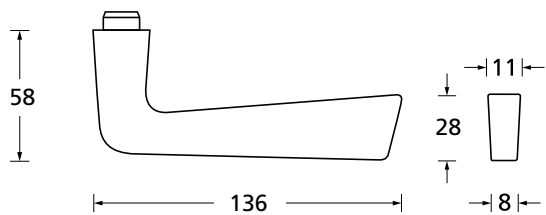



Pullbloc® 3.0 Kugellagertechnik



BB - Garnitur EDELSTAHL poliert



PZ - Garnitur EDELSTAHL poliert



WC - Garnitur EDELSTAHL poliert
WC - Garnitur rot/weiß Anzeige EDELSTAHL poliert
WC - Garnitur rot/grün Anzeige EDELSTAHL poliert



PZ - Wechselgarnitur Knopf gerade EDELSTAHL poliert



RZ - Garnitur EDELSTAHL poliert



PZ - Wechselgarnitur Knopf gekröpft EDELSTAHL poliert

Form 1026 auf Quadratrosette

	Edelstahl matt		Edelstahl poliert		PVD Messinggelb	
		€ exkl. MwSt.		€ exkl. MwSt.		€ exkl. MwSt.
Rosettengarnitur						
BB - Garnitur	PB3.0-Q10260	59,90	PB3.0-QP10260	69,90	PB3.0-QPVM10260	79,90
PZ - Garnitur	PB3.0-Q10262	59,90	PB3.0-QP10262	69,90	PB3.0-QPVM10262	79,90
OS - Garnitur (ohne Schlüsselrosette)	PB3.0-Q10260S	55,90	PB3.0-QP10260S	65,90	PB3.0-QPVM10260S	75,90
RZ - Garnitur	PB3.0-Q10268	59,90	PB3.0-QP10268	69,90	PB3.0-QPVM10268	79,90
WC - Garnitur	PB3.0-Q10263	69,90	PB3.0-QP10263	79,90	PB3.0-QPVM10263	89,90
WC - Garnitur rot/weiß Anz.	PB3.0-Q102631	73,90	PB3.0-QP102631	83,90	PB3.0-QPVM102631	93,90
WC - Garnitur rot/grün Anz.	PB3.0-Q102632	73,90	PB3.0-QP102632	83,90	PB3.0-QPVM102632	93,90
PZ-WG - Knopf ger. DIN R/L	PB3.0-Q10265/6	73,90	PB3.0-QP10265/6	83,90	PB3.0-QPVM10265/6	93,90
PZ-WG - Knopf gekr. DIN R/L	PB3.0-Q102651/61	77,90	PB3.0-QP102651/61	87,90	PB3.0-QPVM102651/61	97,90
Drückerpaar						
ohne Rosetten	D10260	29,90	DP10260	37,90	DPVM10260	45,90

Standard-Türstärken: 38 - 42 mm
Aufpreis für Türstärken ab 42 mm: € 5,00



Drücker EDELSTAHL matt
Rosette EDELSTAHL matt



Drücker EDELSTAHL poliert
Rosette EDELSTAHL poliert

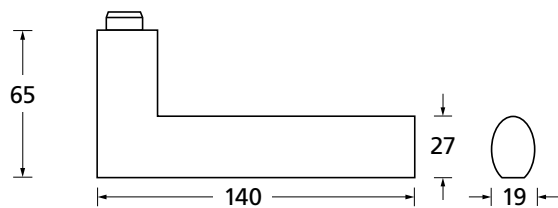



Pullbloc® 3.0 Kugellagertechnik

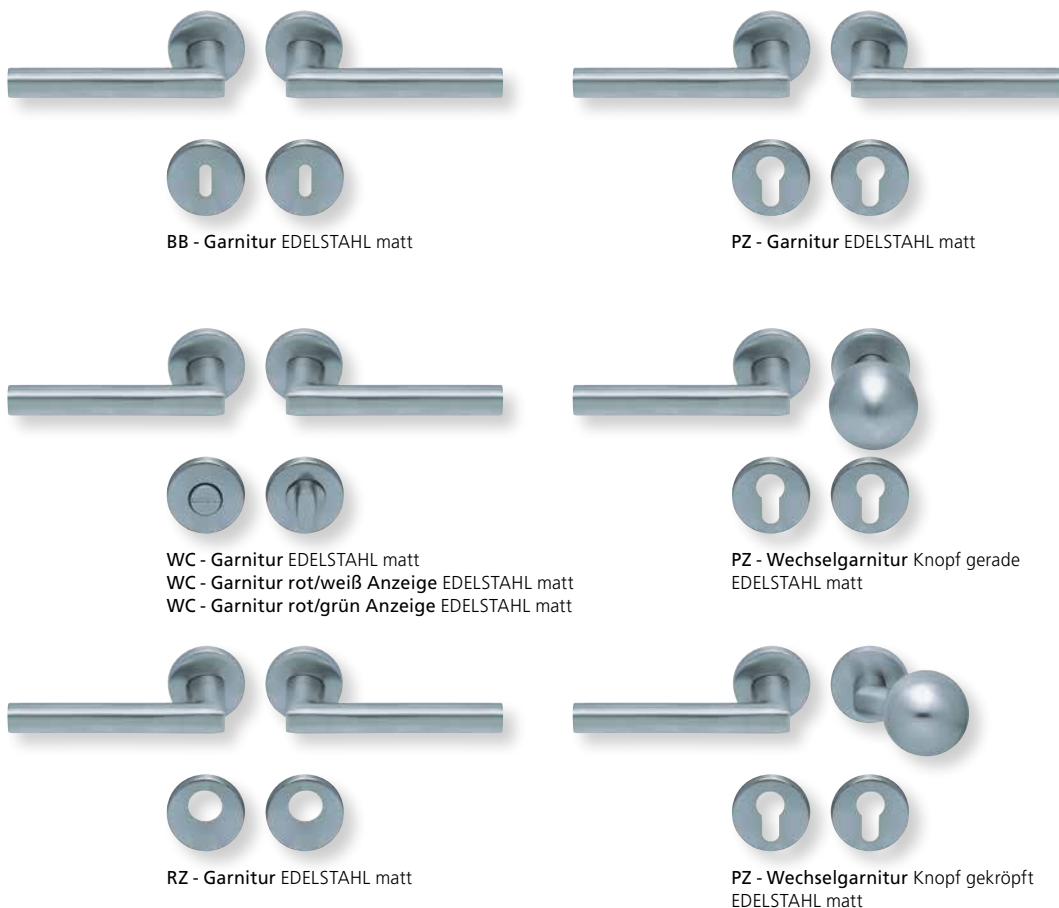

BB - Garnitur EDELSTAHL matt

PZ - Garnitur EDELSTAHL matt

WC - Garnitur EDELSTAHL matt
WC - Garnitur rot/weiß Anzeige EDELSTAHL matt
WC - Garnitur rot/grün Anzeige EDELSTAHL matt

PZ - Wechselgarnitur Knopf gerade EDELSTAHL matt

RZ - Garnitur EDELSTAHL matt

PZ - Wechselgarnitur Knopf gekröpft EDELSTAHL matt

Form 1027 auf Rundrosette

	Edelstahl matt		Edelstahl poliert	
		€ exkl. MwSt.		€ exkl. MwSt.
Rosettengarnitur				
BB - Garnitur	PB3.0-10270	53,90	PB3.0-P10270	63,90
PZ - Garnitur	PB3.0-10272	53,90	PB3.0-P10272	63,90
OS - Garnitur (ohne Schlüsselrosette)	PB3.0-1027OS	49,90	PB3.0-P1027OS	59,90
RZ - Garnitur	PB3.0-10278	53,90	PB3.0-P10278	63,90
WC - Garnitur	PB3.0-10273	63,90	PB3.0-P10273	73,90
WC - Garnitur rot/weiß Anz.	PB3.0-102731	67,90	PB3.0-P102731	77,90
WC - Garnitur rot/grün Anz.	PB3.0-102732	67,90	PB3.0-P102732	77,90
PZ-WG - Knopf ger. DIN R/L	PB3.0-10275/6	67,90	PB3.0-P10275/6	77,90
PZ-WG - Knopf gekr. DIN R/L	PB3.0-102751/61	71,90	PB3.0-P102751/61	81,90
Drückerpaar				
ohne Rosetten	D10270	29,90	DP10270	37,90

Standard-Türstärken: 38 - 42 mm
Aufpreis für Türstärken ab 42 mm: € 5,00



Drücker EDELSTAHL matt
Rosette EDELSTAHL matt



Drücker EDELSTAHL poliert
Rosette EDELSTAHL poliert

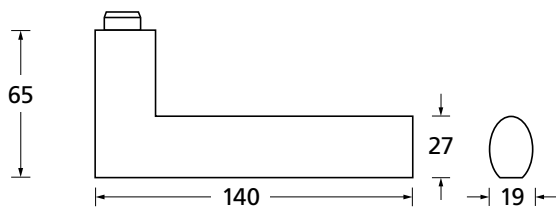



Pullbloc® 3.0 Kugellagertechnik

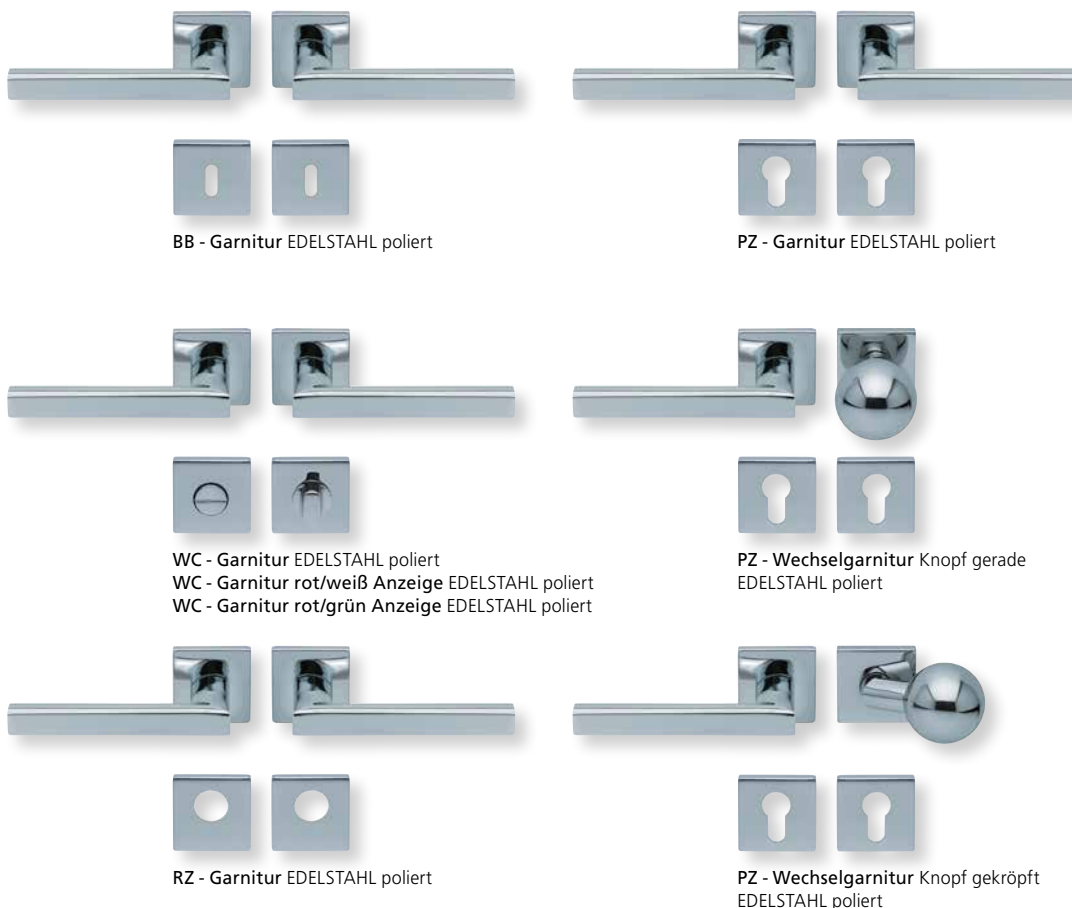

Form 1027 auf Quadratrosette

	Edelstahl matt		Edelstahl poliert	
		€ exkl. MwSt.		€ exkl. MwSt.
Rosettengarnitur				
BB - Garnitur	PB3.0-Q10270	59,90	PB3.0-QP10270	69,90
PZ - Garnitur	PB3.0-Q10272	59,90	PB3.0-QP10272	69,90
OS - Garnitur (ohne Schlüsselrosette)	PB3.0-Q10270S	55,90	PB3.0-QP10270S	65,90
RZ - Garnitur	PB3.0-Q10278	59,90	PB3.0-QP10278	69,90
WC - Garnitur	PB3.0-Q10273	69,90	PB3.0-QP10273	79,90
WC - Garnitur rot/weiß Anz.	PB3.0-Q102731	73,90	PB3.0-QP102731	83,90
WC - Garnitur rot/grün Anz.	PB3.0-Q102732	73,90	PB3.0-QP102732	83,90
PZ-WG - Knopf ger. DIN R/L	PB3.0-Q10275/6	73,90	PB3.0-QP10275/6	83,90
PZ-WG - Knopf gekr. DIN R/L	PB3.0-Q102751/61	77,90	PB3.0-QP102751/61	87,90
Drückerpaar				
ohne Rosetten	D10270	29,90	DP10270	37,90

Standard-Türstärken: 38 - 42 mm
 Aufpreis für Türstärken ab 42 mm: € 5,00

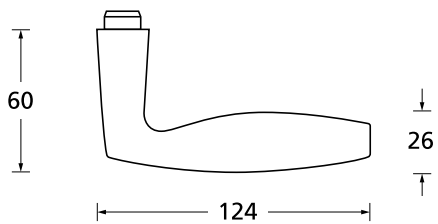



Pullbloc® 3.0 Kugellagertechnik



BB - Garnitur EDELSTAHL matt



PZ - Garnitur EDELSTAHL matt



WC - Garnitur EDELSTAHL matt
WC - Garnitur rot/weiß Anzeige EDELSTAHL matt
WC - Garnitur rot/grün Anzeige EDELSTAHL matt



PZ - Wechselgarnitur Knopf gerade
EDELSTAHL matt



RZ - Garnitur EDELSTAHL matt



PZ - Wechselgarnitur Knopf gekröpft
EDELSTAHL matt

Form 1062 auf Rundrosette

Edelstahl matt

Rosettengarnitur

		€ exkl. MwSt.
BB - Garnitur	PB3.0-10620	53,90
PZ - Garnitur	PB3.0-10622	53,90
OS - Garnitur (ohne Schlüsselrosette)	PB3.0-10620S	49,90
RZ - Garnitur	PB3.0-10628	53,90
WC - Garnitur	PB3.0-10623	63,90
WC - Garnitur rot/weiß Anz.	PB3.0-106231	67,90
WC - Garnitur rot/grün Anz.	PB3.0-106232	67,90
PZ-WG - Knopf ger. DIN R/L	PB3.0-10625/6	67,90
PZ-WG - Knopf gekr. DIN R/L	PB3.0-106251/61	71,90

Drückerpaar

ohne Rosetten	D10620	29,90
---------------	--------	-------

Standard-Türstärken: 38 - 42 mm
Aufpreis für Türstärken ab 42 mm: € 5,00

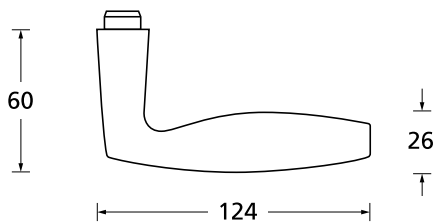



Pullbloc® 3.0 Kugellagertechnik



BB - Garnitur EDELSTAHL matt



PZ - Garnitur EDELSTAHL matt



WC - Garnitur EDELSTAHL matt
 WC - Garnitur rot/weiß Anzeige EDELSTAHL matt
 WC - Garnitur rot/grün Anzeige EDELSTAHL matt

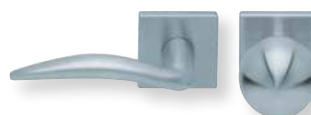

PZ - Wechselgarnitur Knopf gerade EDELSTAHL matt



RZ - Garnitur EDELSTAHL matt

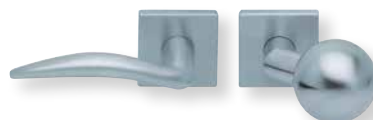

PZ - Wechselgarnitur Knopf gekröpft EDELSTAHL matt

Form 1062 auf Quadratrosette

Edelstahl matt

Rosettengarnitur

		€ exkl. MwSt.
BB - Garnitur	PB3.0-Q10620	59,90
PZ - Garnitur	PB3.0-Q10622	59,90
OS - Garnitur (ohne Schlüsselrosette)	PB3.0-Q10620S	55,90
RZ - Garnitur	PB3.0-Q10628	59,90
WC - Garnitur	PB3.0-Q10623	69,90
WC - Garnitur rot/weiß Anz.	PB3.0-Q106231	73,90
WC - Garnitur rot/grün Anz.	PB3.0-Q106232	73,90
PZ-WG - Knopf ger. DIN R/L	PB3.0-Q10625/6	73,90
PZ-WG - Knopf gekr. DIN R/L	PB3.0-Q106251/61	77,90

Drückerpaar

ohne Rosetten	D10620	29,90
---------------	--------	-------

Standard-Türstärken: 38 - 42 mm
 Aufpreis für Türstärken ab 42 mm: € 5,00



Drücker EDELSTAHL matt
Rosette EDELSTAHL matt

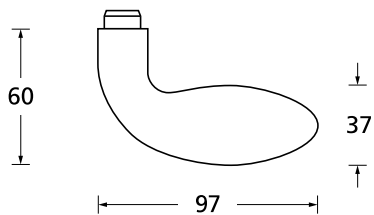



Pullbloc® 3.0 Kugellagertechnik

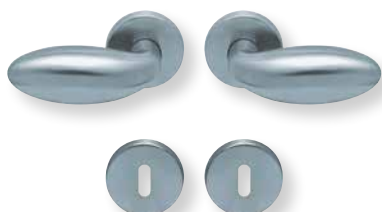

BB - Garnitur EDELSTAHL matt



PZ - Garnitur EDELSTAHL matt



WC - Garnitur EDELSTAHL matt
 WC - Garnitur rot/weiß Anzeige EDELSTAHL matt
 WC - Garnitur rot/grün Anzeige EDELSTAHL matt



PZ - Wechselgarnitur Knopf gerade EDELSTAHL matt



RZ - Garnitur EDELSTAHL matt



PZ - Wechselgarnitur Knopf gekröpft EDELSTAHL matt

Form 1066 auf Rundrosette

Edelstahl matt

Rosettengarnitur

		€ exkl. MwSt.
BB - Garnitur	PB3.0-10660	53,90
PZ - Garnitur	PB3.0-10662	53,90
OS - Garnitur (ohne Schlüsselrosette)	PB3.0-10660S	49,90
RZ - Garnitur	PB3.0-10668	53,90
WC - Garnitur	PB3.0-10663	63,90
WC - Garnitur rot/weiß Anz.	PB3.0-106631	67,90
WC - Garnitur rot/grün Anz.	PB3.0-106632	67,90
PZ-WG - Knopf ger. DIN R/L	PB3.0-10665/6	67,90
PZ-WG - Knopf gekr. DIN R/L	PB3.0-106651/61	71,90

Drückerpaar

ohne Rosetten	D10660	29,90
---------------	--------	-------

Standard-Türstärken: 38 - 42 mm
 Aufpreis für Türstärken ab 42 mm: € 5,00



Drücker EDELSTAHL matt
Rosette EDELSTAHL matt

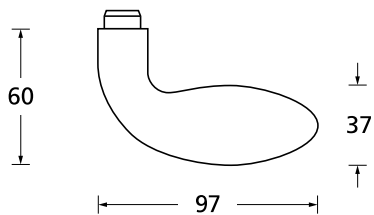



Pullbloc® 3.0 Kugellagertechnik



BB - Garnitur EDELSTAHL matt



PZ - Garnitur EDELSTAHL matt



WC - Garnitur EDELSTAHL matt
WC - Garnitur rot/weiß Anzeige EDELSTAHL matt
WC - Garnitur rot/grün Anzeige EDELSTAHL matt



PZ - Wechselgarnitur Knopf gerade EDELSTAHL matt



RZ - Garnitur EDELSTAHL matt



PZ - Wechselgarnitur Knopf gekröpft EDELSTAHL matt

Form 1066 auf Quadratrosette

Edelstahl matt

Rosettengarnitur

		€ exkl. MwSt.
BB - Garnitur	PB3.0-Q10660	59,90
PZ - Garnitur	PB3.0-Q10662	59,90
OS - Garnitur (ohne Schlüsselrosette)	PB3.0-Q1066OS	55,90
RZ - Garnitur	PB3.0-Q10668	59,90
WC - Garnitur	PB3.0-Q10663	69,90
WC - Garnitur rot/weiß Anz.	PB3.0-Q106631	73,90
WC - Garnitur rot/grün Anz.	PB3.0-Q106632	73,90
PZ-WG - Knopf ger. DIN R/L	PB3.0-Q10665/6	73,90
PZ-WG - Knopf gekr. DIN R/L	PB3.0-Q106651/61	77,90

Drückerpaar

ohne Rosetten	D10660	29,90
---------------	--------	-------

Standard-Türstärken: 38 - 42 mm
Aufpreis für Türstärken ab 42 mm: € 5,00



Drücker EDELSTAHL matt
Rosette EDELSTAHL matt



Drücker EDELSTAHL poliert
Rosette EDELSTAHL poliert

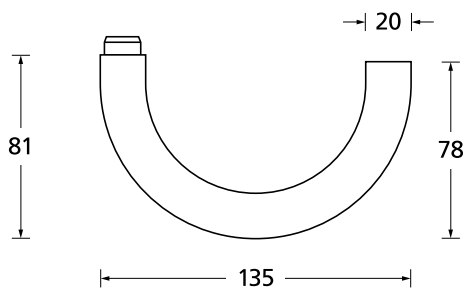



Pullbloc® 3.0 Kugellagertechnik

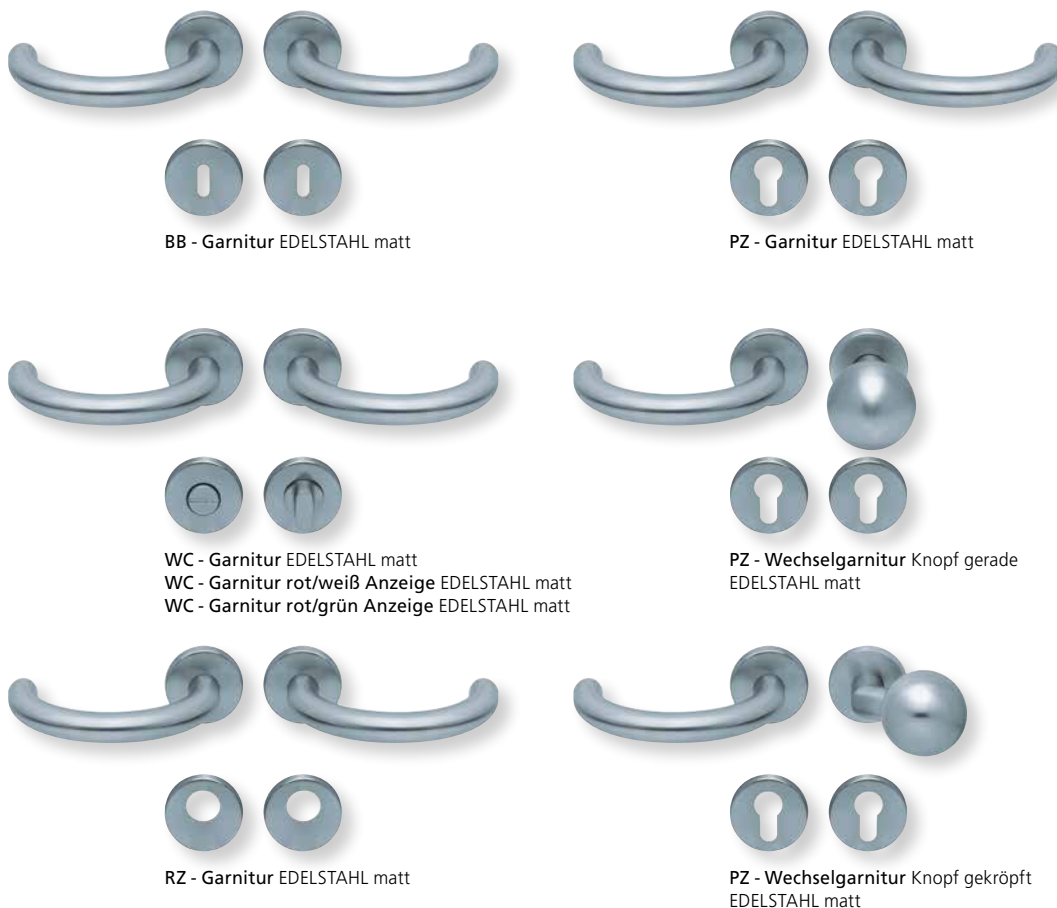

Form 1070 auf Rundrosette

	Edelstahl matt		Edelstahl poliert	
	€ exkl. MwSt.		€ exkl. MwSt.	
Rosettengarnitur				
BB - Garnitur	PB3.0-10700	47,90	PB3.0-P10700	57,90
PZ - Garnitur	PB3.0-10702	47,90	PB3.0-P10702	57,90
OS - Garnitur (ohne Schlüsselrosette)	PB3.0-10700S	43,90	PB3.0-P10700S	53,90
RZ - Garnitur	PB3.0-10708	47,90	PB3.0-P10708	57,90
WC - Garnitur	PB3.0-10703	57,90	PB3.0-P10703	67,90
WC - Garnitur rot/weiß Anz.	PB3.0-107031	61,90	PB3.0-P107031	71,90
WC - Garnitur rot/grün Anz.	PB3.0-107032	61,90	PB3.0-P107032	71,90
PZ-WG - Knopf ger. DIN R/L	PB3.0-10705/6	61,90	PB3.0-P10705/6	71,90
PZ-WG - Knopf gekr. DIN R/L	PB3.0-107051/61	65,90	PB3.0-P107051/61	75,90
Drückerpaar				
ohne Rosetten	D10700	25,90	DP10700	33,90

Standard-Türstärken: 38 - 42 mm
Aufpreis für Türstärken ab 42 mm: € 5,00

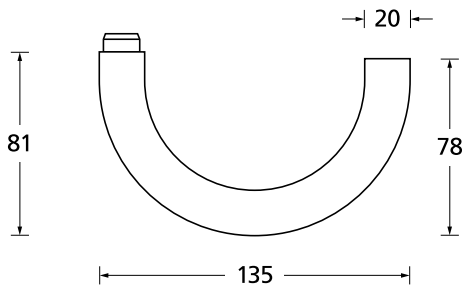

Alle Drückerformen sind kombinierbar mit **verschiedenen Ausführungen** von: **LANG- und KURZSCHILDERN**, **LANG- und KURZSCHILDERN SCHMAL** Seite 234 - 245, **SICHERHEITSROSETTEN** Seite 326 - 329, **ROSETTEN für SCHMALRAHMENTÜREN** Seite 216 - 219, **FLÄCHENBÜNDIGE OPTIK**, **QUADRATROSETTEN FLACH MIT SCHNELLMONTAGE** Seite 220 - 225.



Pullbloc® 3.0 Kugellagertechnik



BB - Garnitur EDELSTAHL poliert



PZ - Garnitur EDELSTAHL poliert



WC - Garnitur EDELSTAHL poliert
WC - Garnitur rot/weiß Anzeige EDELSTAHL poliert
WC - Garnitur rot/grün Anzeige EDELSTAHL poliert



PZ - Wechselgarnitur Knopf gerade EDELSTAHL poliert



RZ - Garnitur EDELSTAHL poliert



PZ - Wechselgarnitur Knopf gekröpft EDELSTAHL poliert

Form 1070 auf Quadratrosette

Rosettengarnitur	Edelstahl matt		Edelstahl poliert	
		€ exkl. MwSt.		€ exkl. MwSt.
BB - Garnitur	PB3.0-Q10700	53,90	PB3.0-QP10700	63,90
PZ - Garnitur	PB3.0-Q10702	53,90	PB3.0-QP10702	63,90
OS - Garnitur (ohne Schlüsselrosette)	PB3.0-Q10700S	49,90	PB3.0-QP10700S	59,90
RZ - Garnitur	PB3.0-Q10708	53,90	PB3.0-QP10708	63,90
WC - Garnitur	PB3.0-Q10703	63,90	PB3.0-QP10703	73,90
WC - Garnitur rot/weiß Anz.	PB3.0-Q107031	67,90	PB3.0-QP107031	77,90
WC - Garnitur rot/grün Anz.	PB3.0-Q107032	67,90	PB3.0-QP107032	77,90
PZ-WG - Knopf ger. DIN R/L	PB3.0-Q10705/6	67,90	PB3.0-QP10705/6	77,90
PZ-WG - Knopf gekr. DIN R/L	PB3.0-Q107051/61	71,90	PB3.0-QP107051/61	81,90
Drückerpaar				
ohne Rosetten	D10700	25,90	DP10700	33,90

Standard-Türstärken: 38 - 42 mm
Aufpreis für Türstärken ab 42 mm: € 5,00



Drücker EDELSTAHL matt
Rosette EDELSTAHL matt



Drücker EDELSTAHL poliert
Rosette EDELSTAHL poliert

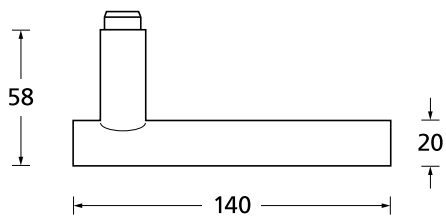



Pullbloc® 3.0 Kugellagertechnik

117



BB - Garnitur EDELSTAHL matt



PZ - Garnitur EDELSTAHL matt



WC - Garnitur EDELSTAHL matt
WC - Garnitur rot/weiß Anzeige EDELSTAHL matt
WC - Garnitur rot/grün Anzeige EDELSTAHL matt



PZ - Wechselgarnitur Knopf gerade
EDELSTAHL matt



RZ - Garnitur EDELSTAHL matt



PZ - Wechselgarnitur Knopf gekröpft
EDELSTAHL matt

Form 1074 auf Rundrosette

	Edelstahl matt		Edelstahl poliert	
		€ exkl. MwSt.		€ exkl. MwSt.
Rosettengarnitur				
BB - Garnitur	PB3.0-10740	41,90	PB3.0-P10740	51,90
PZ - Garnitur	PB3.0-10742	41,90	PB3.0-P10742	51,90
OS - Garnitur (ohne Schlüsselrosette)	PB3.0-1074OS	37,90	PB3.0-P1074OS	47,90
RZ - Garnitur	PB3.0-10748	41,90	PB3.0-P10748	51,90
WC - Garnitur	PB3.0-10743	51,90	PB3.0-P10743	61,90
WC - Garnitur rot/weiß Anz.	PB3.0-107431	55,90	PB3.0-P107431	65,90
WC - Garnitur rot/grün Anz.	PB3.0-107432	55,90	PB3.0-P107432	65,90
PZ-WG - Knopf ger. DIN R/L	PB3.0-10745/6	55,90	PB3.0-P10745/6	65,90
PZ-WG - Knopf gekr. DIN R/L	PB3.0-107451/61	59,90	PB3.0-P107451/61	69,90
Drückerpaar				
ohne Rosetten	D10740	19,90	DP10740	27,90

Standard-Türstärken: 38 - 42 mm
Aufpreis für Türstärken ab 42 mm: € 5,00



Drücker EDELSTAHL matt
Rosette EDELSTAHL matt



Drücker EDELSTAHL poliert
Rosette EDELSTAHL poliert

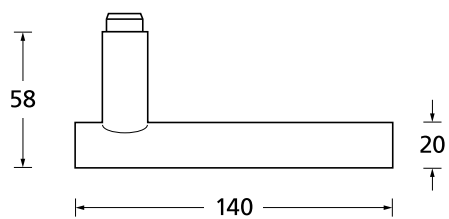



Pullbloc® 3.0 Kugellagertechnik



BB - Garnitur EDELSTAHL poliert



PZ - Garnitur EDELSTAHL poliert



WC - Garnitur EDELSTAHL poliert
WC - Garnitur rot/weiß Anzeige EDELSTAHL poliert
WC - Garnitur rot/grün Anzeige EDELSTAHL poliert



PZ - Wechselgarnitur Knopf gerade EDELSTAHL poliert



RZ - Garnitur EDELSTAHL poliert



PZ - Wechselgarnitur Knopf gekröpft EDELSTAHL poliert

Form 1074 auf Quadratrosette

	Edelstahl matt		Edelstahl poliert	
		€ exkl. MwSt.		€ exkl. MwSt.
Rosettengarnitur				
BB - Garnitur	PB3.0-Q10740	47,90	PB3.0-QP10740	57,90
PZ - Garnitur	PB3.0-Q10742	47,90	PB3.0-QP10742	57,90
OS - Garnitur (ohne Schlüsselrosette)	PB3.0-Q10740S	43,90	PB3.0-QP10740S	53,90
RZ - Garnitur	PB3.0-Q10748	47,90	PB3.0-QP10748	57,90
WC - Garnitur	PB3.0-Q10743	57,90	PB3.0-QP10743	67,90
WC - Garnitur rot/weiß Anz.	PB3.0-Q107431	61,90	PB3.0-QP107431	71,90
WC - Garnitur rot/grün Anz.	PB3.0-Q107432	61,90	PB3.0-QP107432	71,90
PZ-WG - Knopf ger. DIN R/L	PB3.0-Q10745/6	61,90	PB3.0-QP10745/6	71,90
PZ-WG - Knopf gekr. DIN R/L	PB3.0-Q107451/61	65,90	PB3.0-QP107451/61	75,90
Drückerpaar				
ohne Rosetten	D10740	19,90	DP10740	27,90

Standard-Türstärken: 38 - 42 mm
Aufpreis für Türstärken ab 42 mm: € 5,00



Drücker EDELSTAHL matt
Rosette EDELSTAHL matt



Drücker EDELSTAHL poliert
Rosette EDELSTAHL poliert



Drücker PVD Messinggelb
Rosette PVD Messinggelb

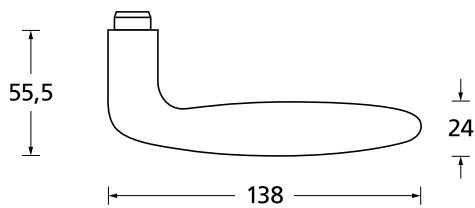



Pullbloc® 3.0 Kugellagertechnik

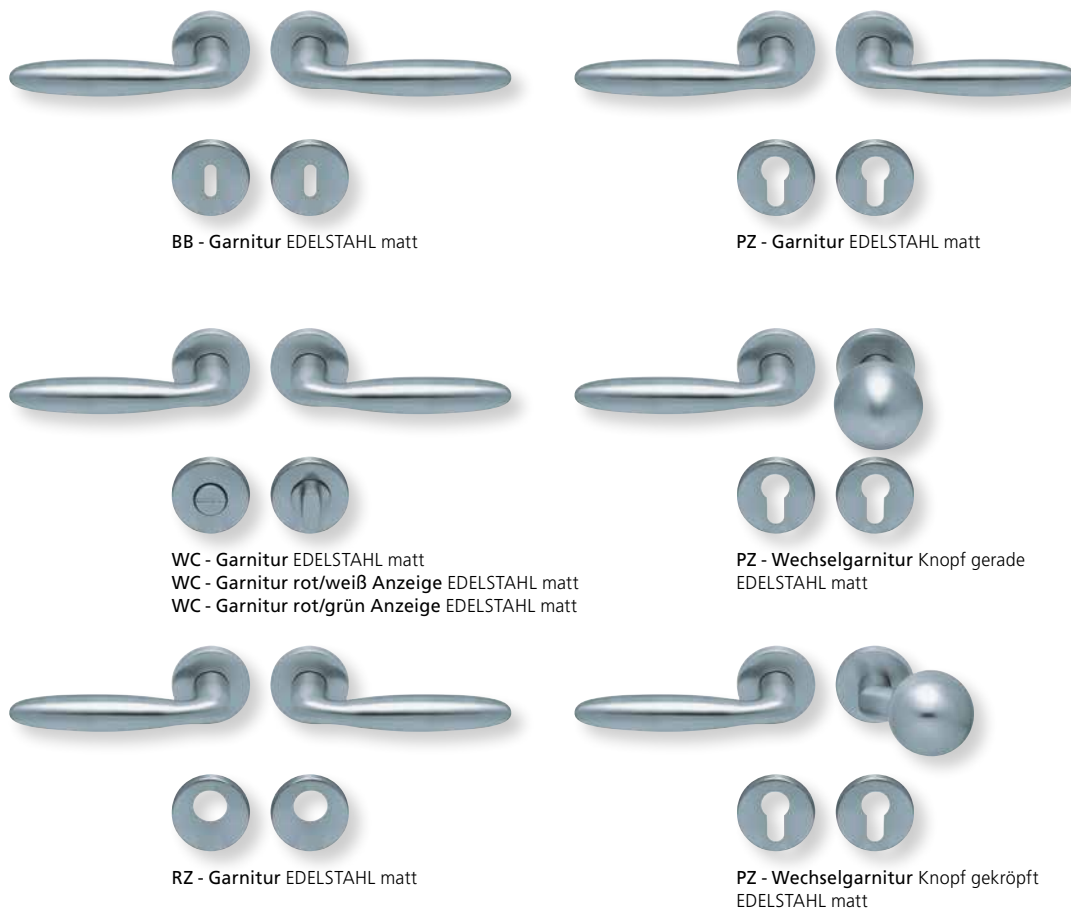

BB - Garnitur EDELSTAHL matt

PZ - Garnitur EDELSTAHL matt

WC - Garnitur EDELSTAHL matt
WC - Garnitur rot/weiß Anzeige EDELSTAHL matt
WC - Garnitur rot/grün Anzeige EDELSTAHL matt

PZ - Wechselgarnitur Knopf gerade EDELSTAHL matt

RZ - Garnitur EDELSTAHL matt

PZ - Wechselgarnitur Knopf gekröpft EDELSTAHL matt

Form 1083 auf Rundrosette

	Edelstahl matt		Edelstahl poliert		PVD Messinggelb	
	€ exkl. MwSt.		€ exkl. MwSt.		€ exkl. MwSt.	
Rosettengarnitur						
BB - Garnitur	PB3.0-10830	47,90	PB3.0-P10830	57,90	PB3.0-PVM10830	67,90
PZ - Garnitur	PB3.0-10832	47,90	PB3.0-P10832	57,90	PB3.0-PVM10832	67,90
OS - Garnitur (ohne Schlüsselrosette)	PB3.0-10830S	43,90	PB3.0-P10830S	53,90	PB3.0-PVM10830S	63,90
RZ - Garnitur	PB3.0-10838	47,90	PB3.0-P10838	57,90	PB3.0-PVM10838	67,90
WC - Garnitur	PB3.0-10833	57,90	PB3.0-P10833	67,90	PB3.0-PVM10833	77,90
WC - Garnitur rot/weiß Anz.	PB3.0-108331	61,90	PB3.0-P108331	71,90	PB3.0-PVM108331	81,90
WC - Garnitur rot/grün Anz.	PB3.0-108332	61,90	PB3.0-P108332	71,90	PB3.0-PVM108332	81,90
PZ-WG - Knopf ger. DIN R/L	PB3.0-10835/6	61,90	PB3.0-P10835/6	71,90	PB3.0-PVM10835/6	81,90
PZ-WG - Knopf gekr. DIN R/L	PB3.0-108351/61	65,90	PB3.0-P108351/61	75,90	PB3.0-PVM108351/61	85,90
Drückerpaar						
ohne Rosetten	D10830	25,90	DP10830	33,90	DPVM10830	41,90

Standard-Türstärken: 38 - 42 mm
Aufpreis für Türstärken ab 42 mm: € 5,00



Drücker EDELSTAHL matt
Rosette EDELSTAHL matt



Drücker EDELSTAHL poliert
Rosette EDELSTAHL poliert



Drücker PVD Messinggelb
Rosette PVD Messinggelb

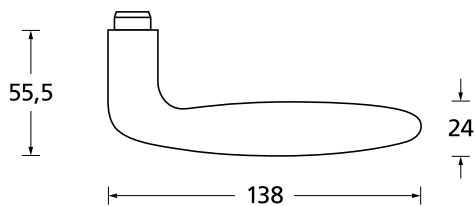



Pullbloc® 3.0 Kugellagertechnik



BB - Garnitur EDELSTAHL poliert



PZ - Garnitur EDELSTAHL poliert



WC - Garnitur EDELSTAHL poliert
WC - Garnitur rot/weiß Anzeige EDELSTAHL poliert
WC - Garnitur rot/grün Anzeige EDELSTAHL poliert



PZ - Wechselgarnitur Knopf gerade EDELSTAHL poliert



RZ - Garnitur EDELSTAHL poliert



PZ - Wechselgarnitur Knopf gekröpft EDELSTAHL poliert

Form 1083 auf Quadratrosette

	Edelstahl matt		Edelstahl poliert		PVD Messinggelb	
	€ exkl. MwSt.		€ exkl. MwSt.		€ exkl. MwSt.	
Rosettengarnitur						
BB - Garnitur	PB3.0-Q10830	53,90	PB3.0-QP10830	63,90	PB3.0-QPVM10830	73,90
PZ - Garnitur	PB3.0-Q10832	53,90	PB3.0-QP10832	63,90	PB3.0-QPVM10832	73,90
OS - Garnitur (ohne Schlüsselrosette)	PB3.0-Q10830S	49,90	PB3.0-QP10830S	59,90	PB3.0-QPVM10830S	69,90
RZ - Garnitur	PB3.0-Q10838	53,90	PB3.0-QP10838	63,90	PB3.0-QPVM10838	73,90
WC - Garnitur	PB3.0-Q10833	63,90	PB3.0-QP10833	73,90	PB3.0-QPVM10833	83,90
WC - Garnitur rot/weiß Anz.	PB3.0-Q108331	67,90	PB3.0-QP108331	77,90	PB3.0-QPVM108331	87,90
WC - Garnitur rot/grün Anz.	PB3.0-Q108332	67,90	PB3.0-QP108332	77,90	PB3.0-QPVM108332	87,90
PZ-WG - Knopf ger. DIN R/L	PB3.0-Q10835/6	67,90	PB3.0-QP10835/6	77,90	PB3.0-QPVM10835/6	87,90
PZ-WG - Knopf gekr. DIN R/L	PB3.0-Q108351/61	71,90	PB3.0-QP108351/61	81,90	PB3.0-QPVM108351/61	91,90
Drückerpaar						
ohne Rosetten	D10830	25,90	DP10830	33,90	DPVM10830	41,90

Standard-Türstärken: 38 - 42 mm
Aufpreis für Türstärken ab 42 mm: € 5,00



Drücker EDELSTAHL matt
Rosette EDELSTAHL matt



Drücker EDELSTAHL poliert
Rosette EDELSTAHL poliert



Drücker PVD Messinggelb
Rosette PVD Messinggelb

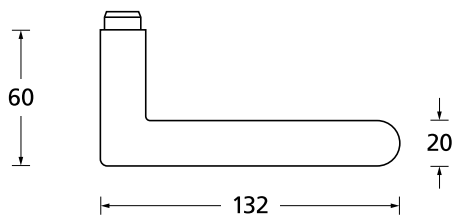



Pullbloc® 3.0 Kugellagertechnik

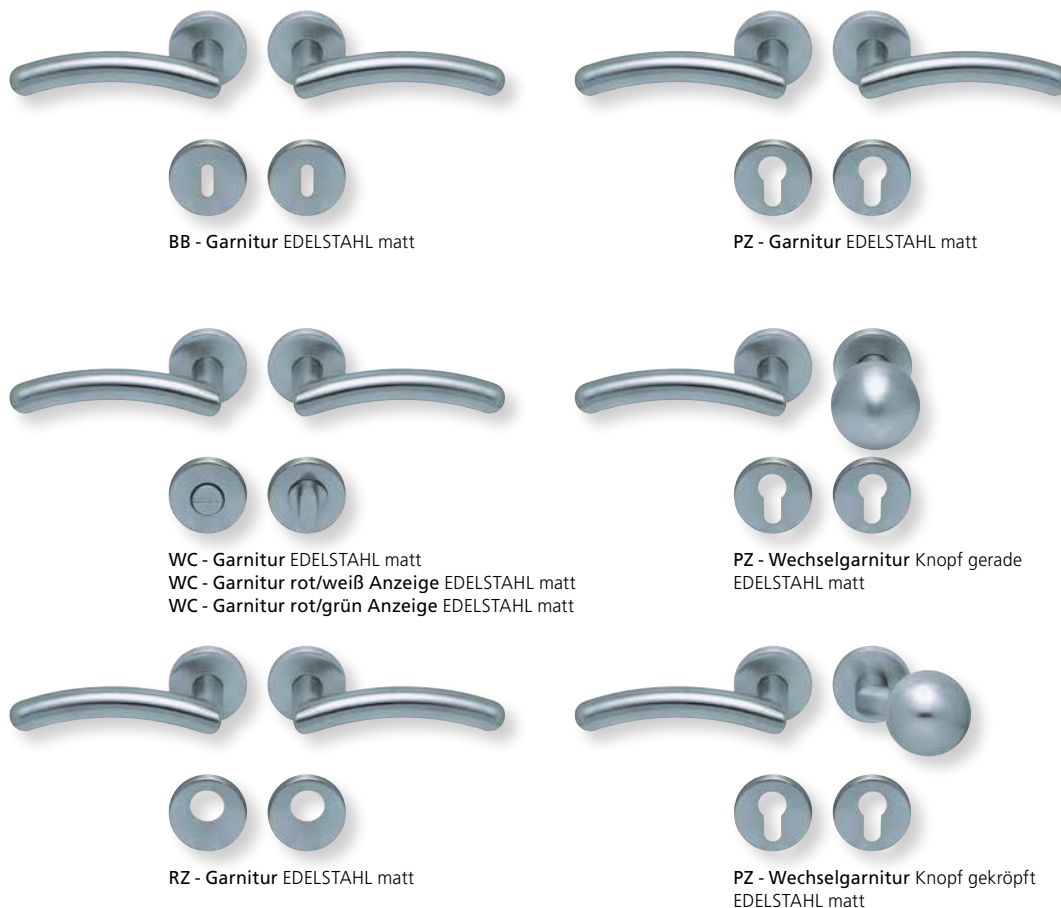

Form 1084 auf Rundrosette

	Edelstahl matt		Edelstahl poliert		PVD Messinggelb	
		€ exkl. MwSt.		€ exkl. MwSt.		€ exkl. MwSt.
Rosettengarnitur						
BB - Garnitur	PB3.0-10840	41,90	PB3.0-P10840	51,90	PB3.0-PVM10840	61,90
PZ - Garnitur	PB3.0-10842	41,90	PB3.0-P10842	51,90	PB3.0-PVM10842	61,90
OS - Garnitur (ohne Schlüsselrosette)	PB3.0-10840S	37,90	PB3.0-P10840S	47,90	PB3.0-PVM10840S	57,90
RZ - Garnitur	PB3.0-10848	41,90	PB3.0-P10848	51,90	PB3.0-PVM10848	61,90
WC - Garnitur	PB3.0-10843	51,90	PB3.0-P10843	61,90	PB3.0-PVM10843	71,90
WC - Garnitur rot/weiß Anz.	PB3.0-108431	55,90	PB3.0-P108431	65,90	PB3.0-PVM108431	75,90
WC - Garnitur rot/grün Anz.	PB3.0-108432	55,90	PB3.0-P108432	65,90	PB3.0-PVM108432	75,90
PZ-WG - Knopf ger. DIN R/L	PB3.0-10845/6	55,90	PB3.0-P10845/6	65,90	PB3.0-PVM10845/6	75,90
PZ-WG - Knopf gekr. DIN R/L	PB3.0-108451/61	59,90	PB3.0-P108451/61	69,90	PB3.0-PVM108451/61	79,90
Drückerpaar						
ohne Rosetten	D10840	19,90	DP10840	27,90	DPVM10840	35,90

Standard-Türstärken: 38 - 42 mm
 Aufpreis für Türstärken ab 42 mm: € 5,00



Drücker EDELSTAHL matt
Rosette EDELSTAHL matt



Drücker EDELSTAHL poliert
Rosette EDELSTAHL poliert

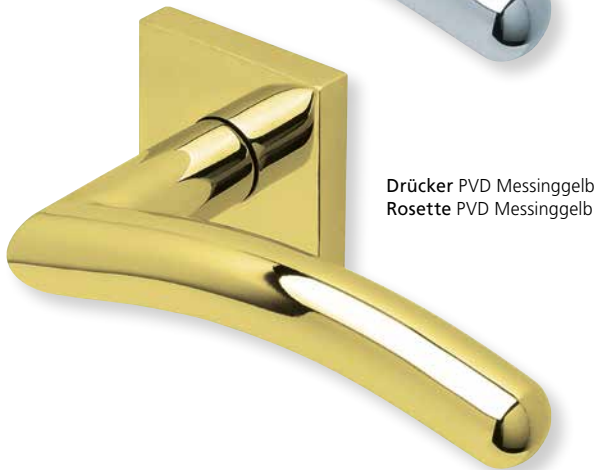

Drücker PVD Messinggelb
Rosette PVD Messinggelb

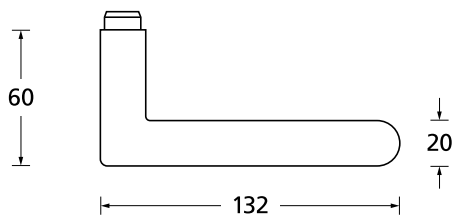



Pullbloc® 3.0 Kugellagertechnik



BB - Garnitur EDELSTAHL poliert



PZ - Garnitur EDELSTAHL poliert



WC - Garnitur EDELSTAHL poliert
WC - Garnitur rot/weiß Anzeige EDELSTAHL poliert
WC - Garnitur rot/grün Anzeige EDELSTAHL poliert



PZ - Wechselgarnitur Knopf gerade EDELSTAHL poliert



RZ - Garnitur EDELSTAHL poliert



PZ - Wechselgarnitur Knopf gekröpft EDELSTAHL poliert

Form 1084 auf Quadratrosette

	Edelstahl matt		Edelstahl poliert		PVD Messinggelb	
	€ exkl. MwSt.		€ exkl. MwSt.		€ exkl. MwSt.	
Rosettengarnitur						
BB - Garnitur	PB3.0-Q10840	47,90	PB3.0-QP10840	57,90	PB3.0-QPVM10840	67,90
PZ - Garnitur	PB3.0-Q10842	47,90	PB3.0-QP10842	57,90	PB3.0-QPVM10842	67,90
OS - Garnitur (ohne Schlüsselrosette)	PB3.0-Q10840S	43,90	PB3.0-QP10840S	53,90	PB3.0-QPVM10840S	63,90
RZ - Garnitur	PB3.0-Q10848	47,90	PB3.0-QP10848	57,90	PB3.0-QPVM10848	67,90
WC - Garnitur	PB3.0-Q10843	57,90	PB3.0-QP10843	67,90	PB3.0-QPVM10843	77,90
WC - Garnitur rot/weiß Anz.	PB3.0-Q108431	61,90	PB3.0-QP108431	71,90	PB3.0-QPVM108431	81,90
WC - Garnitur rot/grün Anz.	PB3.0-Q108432	61,90	PB3.0-QP108432	71,90	PB3.0-QPVM108432	81,90
PZ-WG - Knopf ger. DIN R/L	PB3.0-Q10845/6	61,90	PB3.0-QP10845/6	71,90	PB3.0-QPVM10845/6	81,90
PZ-WG - Knopf gekr. DIN R/L	PB3.0-Q108451/61	65,90	PB3.0-QP108451/61	75,90	PB3.0-QPVM108451/61	85,90
Drückerpaar						
ohne Rosetten	D10840	19,90	DP10840	27,90	DPVM10840	35,90

Standard-Türstärken: 38 - 42 mm
Aufpreis für Türstärken ab 42 mm: € 5,00



Drücker EDELSTAHL matt
Rosette EDELSTAHL matt



Drücker EDELSTAHL poliert
Rosette EDELSTAHL poliert



Drücker PVD Messinggelb
Rosette PVD Messinggelb

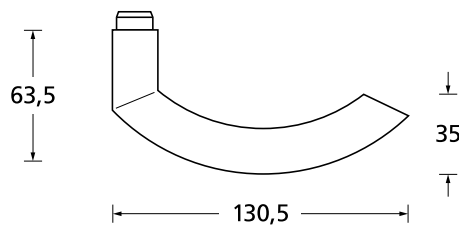



Pullbloc® 3.0 Kugellagertechnik



BB - Garnitur EDELSTAHL matt



PZ - Garnitur EDELSTAHL matt



WC - Garnitur EDELSTAHL matt
WC - Garnitur rot/weiß Anzeige EDELSTAHL matt
WC - Garnitur rot/grün Anzeige EDELSTAHL matt



PZ - Wechselgarnitur Knopf gerade
EDELSTAHL matt



RZ - Garnitur EDELSTAHL matt



PZ - Wechselgarnitur Knopf gekröpft
EDELSTAHL matt

Form 1085 auf Rundrosette

	Edelstahl matt		Edelstahl poliert		PVD Messinggelb	
	€ exkl. MwSt.		€ exkl. MwSt.		€ exkl. MwSt.	
Rosettengarnitur						
BB - Garnitur	PB3.0-10850	41,90	PB3.0-P10850	51,90	PB3.0-PVM10850	61,90
PZ - Garnitur	PB3.0-10852	41,90	PB3.0-P10852	51,90	PB3.0-PVM10852	61,90
OS - Garnitur (ohne Schlüsselrosette)	PB3.0-10850S	37,90	PB3.0-P10850S	47,90	PB3.0-PVM10850S	57,90
RZ - Garnitur	PB3.0-10858	41,90	PB3.0-P10858	51,90	PB3.0-PVM10858	61,90
WC - Garnitur	PB3.0-10853	51,90	PB3.0-P10853	61,90	PB3.0-PVM10853	71,90
WC - Garnitur rot/weiß Anz.	PB3.0-108531	55,90	PB3.0-P108531	65,90	PB3.0-PVM108531	75,90
WC - Garnitur rot/grün Anz.	PB3.0-108532	55,90	PB3.0-P108532	65,90	PB3.0-PVM108532	75,90
PZ-WG - Knopf ger. DIN R/L	PB3.0-10855/6	55,90	PB3.0-P10855/6	65,90	PB3.0-PVM10855/6	75,90
PZ-WG - Knopf gekr. DIN R/L	PB3.0-108551/61	59,90	PB3.0-P108551/61	69,90	PB3.0-PVM108551/61	79,90
Drückerpaar						
ohne Rosetten	D10850	19,90	DP10850	27,90	DPVM10850	35,90

Standard-Türstärken: 38 - 42 mm
Aufpreis für Türstärken ab 42 mm: € 5,00



Drücker EDELSTAHL matt
Rosette EDELSTAHL matt



Drücker EDELSTAHL poliert
Rosette EDELSTAHL poliert



Drücker PVD Messinggelb
Rosette PVD Messinggelb

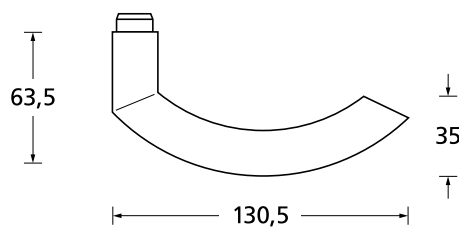



Pullbloc® 3.0 Kugellagertechnik



BB - Garnitur EDELSTAHL poliert



PZ - Garnitur EDELSTAHL poliert



WC - Garnitur EDELSTAHL poliert
WC - Garnitur rot/weiß Anzeige EDELSTAHL poliert
WC - Garnitur rot/grün Anzeige EDELSTAHL poliert



PZ - Wechselgarnitur Knopf gerade EDELSTAHL poliert



RZ - Garnitur EDELSTAHL poliert



PZ - Wechselgarnitur Knopf gekröpft EDELSTAHL poliert

Form 1085 auf Quadratrosette

	Edelstahl matt		Edelstahl poliert		PVD Messinggelb	
	€ exkl. MwSt.		€ exkl. MwSt.		€ exkl. MwSt.	
Rosettengarnitur						
BB - Garnitur	PB3.0-Q10850	47,90	PB3.0-QP10850	57,90	PB3.0-QPVM10850	67,90
PZ - Garnitur	PB3.0-Q10852	47,90	PB3.0-QP10852	57,90	PB3.0-QPVM10852	67,90
OS - Garnitur (ohne Schlüsselrosette)	PB3.0-Q10850S	43,90	PB3.0-QP10850S	53,90	PB3.0-QPVM10850S	63,90
RZ - Garnitur	PB3.0-Q10858	47,90	PB3.0-QP10858	57,90	PB3.0-QPVM10858	67,90
WC - Garnitur	PB3.0-Q10853	57,90	PB3.0-QP10853	67,90	PB3.0-QPVM10853	77,90
WC - Garnitur rot/weiß Anz.	PB3.0-Q108531	61,90	PB3.0-QP108531	71,90	PB3.0-QPVM108531	81,90
WC - Garnitur rot/grün Anz.	PB3.0-Q108532	61,90	PB3.0-QP108532	71,90	PB3.0-QPVM108532	81,90
PZ-WG - Knopf ger. DIN R/L	PB3.0-Q10855/6	61,90	PB3.0-QP10855/6	71,90	PB3.0-QPVM10855/6	81,90
PZ-WG - Knopf gekr. DIN R/L	PB3.0-Q108551/61	65,90	PB3.0-QP108551/61	75,90	PB3.0-QPVM108551/61	85,90
Drückerpaar						
ohne Rosetten	D10850	19,90	DP10850	27,90	DPVM10850	35,90

Standard-Türstärken: 38 - 42 mm
Aufpreis für Türstärken ab 42 mm: € 5,00



Drücker EDELSTAHL matt
Rosette EDELSTAHL matt



Drücker EDELSTAHL poliert
Rosette EDELSTAHL poliert

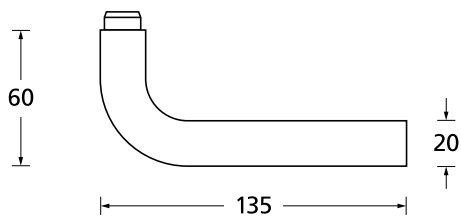



Pullbloc® 3.0 Kugellagertechnik

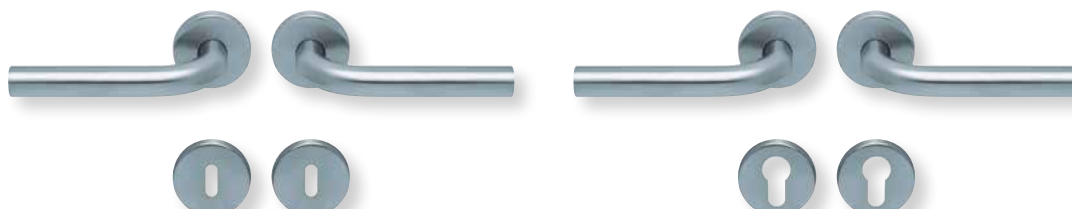

BB - Garnitur EDELSTAHL matt

PZ - Garnitur EDELSTAHL matt

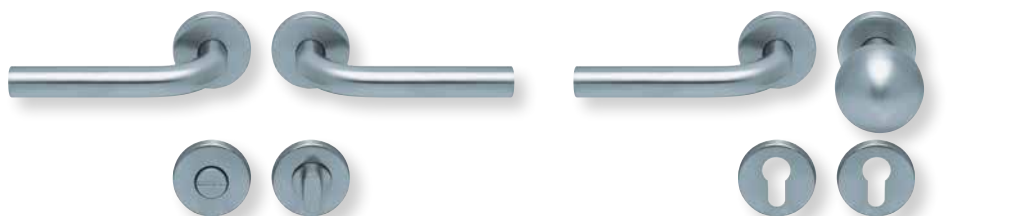

WC - Garnitur EDELSTAHL matt
WC - Garnitur rot/weiß Anzeige EDELSTAHL matt
WC - Garnitur rot/grün Anzeige EDELSTAHL matt

PZ - Wechselgarnitur Knopf gerade EDELSTAHL matt

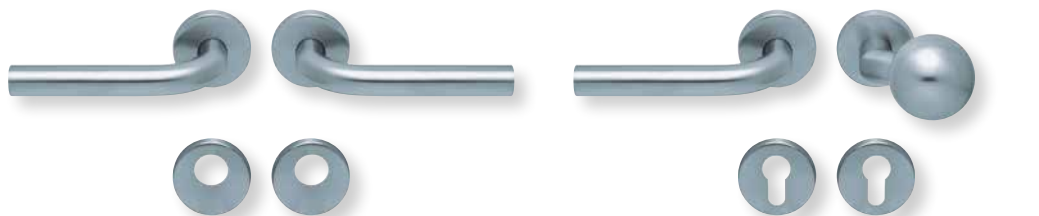

RZ - Garnitur EDELSTAHL matt

PZ - Wechselgarnitur Knopf gekröpft EDELSTAHL matt

Form 1100 auf Rundrosette

	Edelstahl matt		Edelstahl poliert	
		€ exkl. MwSt.		€ exkl. MwSt.
Rosettengarnitur				
BB - Garnitur	PB3.0-11000	41,90	PB3.0-P11000	51,90
PZ - Garnitur	PB3.0-11002	41,90	PB3.0-P11002	51,90
OS - Garnitur (ohne Schlüsselrosette)	PB3.0-1100OS	37,90	PB3.0-P1100OS	47,90
RZ - Garnitur	PB3.0-11008	41,90	PB3.0-P11008	51,90
WC - Garnitur	PB3.0-11003	51,90	PB3.0-P11003	61,90
WC - Garnitur rot/weiß Anz.	PB3.0-110031	54,90	PB3.0-P110031	64,90
WC - Garnitur rot/grün Anz.	PB3.0-110032	54,90	PB3.0-P110032	64,90
PZ-WG - Knopf ger. DIN R/L	PB3.0-11005/6	54,90	PB3.0-P11005/6	64,90
PZ-WG - Knopf gekr. DIN R/L	PB3.0-110051/61	58,90	PB3.0-P110051/61	68,90
Drückerpaar				
ohne Rosetten	D11001	19,90	DP11001	27,90

Standard-Türstärken: 38 - 42 mm
Aufpreis für Türstärken ab 42 mm: € 5,00



Drücker EDELSTAHL matt
Rosette EDELSTAHL matt



Drücker EDELSTAHL poliert
Rosette EDELSTAHL poliert

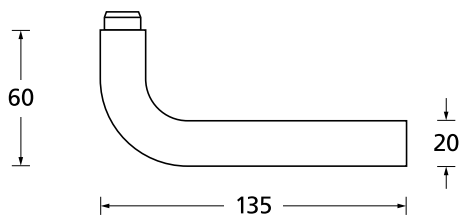



Pullbloc® 3.0 Kugellagertechnik

135



BB - Garnitur EDELSTAHL poliert



PZ - Garnitur EDELSTAHL poliert



WC - Garnitur EDELSTAHL poliert
WC - Garnitur rot/weiß Anzeige EDELSTAHL poliert
WC - Garnitur rot/grün Anzeige EDELSTAHL poliert



PZ - Wechselgarnitur Knopf gerade
EDELSTAHL poliert



RZ - Garnitur EDELSTAHL poliert



PZ - Wechselgarnitur Knopf gekröpft
EDELSTAHL poliert

Form 1100 auf Quadratrosette

Rosettengarnitur	Edelstahl matt		Edelstahl poliert	
		€ exkl. MwSt.		€ exkl. MwSt.
BB - Garnitur	PB3.0-Q11000	47,90	PB3.0-QP11000	57,90
PZ - Garnitur	PB3.0-Q11002	47,90	PB3.0-QP11002	57,90
OS - Garnitur (ohne Schlüsselrosette)	PB3.0-Q11000S	43,90	PB3.0-QP11000S	53,90
RZ - Garnitur	PB3.0-Q11008	47,90	PB3.0-QP11008	57,90
WC - Garnitur	PB3.0-Q11003	57,90	PB3.0-QP11003	67,90
WC - Garnitur rot/weiß Anz.	PB3.0-Q110031	61,90	PB3.0-QP110031	71,90
WC - Garnitur rot/grün Anz.	PB3.0-Q110032	61,90	PB3.0-QP110032	71,90
PZ-WG - Knopf ger. DIN R/L	PB3.0-Q11005/6	61,90	PB3.0-QP11005/6	71,90
PZ-WG - Knopf gekr. DIN R/L	PB3.0-Q110051/61	65,90	PB3.0-QP110051/61	75,90
Drückerpaar				
ohne Rosetten	D11001	19,90	DP11001	27,90

Standard-Türstärken: 38 - 42 mm
Aufpreis für Türstärken ab 42 mm: € 5,00



Drücker EDELSTAHL poliert/EDELSTAHL matt
Rosette EDELSTAHL matt



Drücker EDELSTAHL poliert/EDELSTAHL matt
Rosette EDELSTAHL poliert

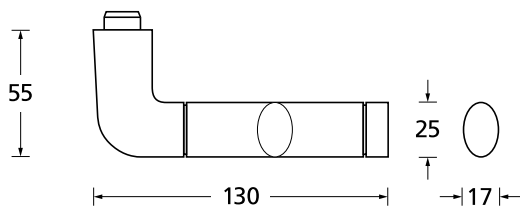



Pullbloc® 3.0 Kugellagertechnik



BB - Garnitur EDELSTAHL poliert



PZ - Garnitur EDELSTAHL poliert



WC - Garnitur EDELSTAHL poliert
WC - Garnitur rot/weiß Anzeige EDELSTAHL poliert
WC - Garnitur rot/grün Anzeige EDELSTAHL poliert



PZ - Wechselgarnitur Knopf gerade EDELSTAHL poliert



RZ - Garnitur EDELSTAHL poliert



PZ - Wechselgarnitur Knopf gekröpft EDELSTAHL poliert

Form 1101 auf Rundrosette

	Edelstahl matt		Edelstahl poliert	
		€ exkl. MwSt.		€ exkl. MwSt.
Rosettengarnitur				
BB - Garnitur	PB3.0-11010	47,90	PB3.0-P11010	52,90
PZ - Garnitur	PB3.0-11012	47,90	PB3.0-P11012	52,90
OS - Garnitur (ohne Schlüsselrosette)	PB3.0-1101OS	43,90	PB3.0-P1101OS	49,90
RZ - Garnitur	PB3.0-11018	47,90	PB3.0-P11018	53,90
WC - Garnitur	PB3.0-11013	57,90	PB3.0-P11013	63,90
WC - Garnitur rot/weiß Anz.	PB3.0-110131	61,90	PB3.0-P110131	67,90
WC - Garnitur rot/grün Anz.	PB3.0-110132	61,90	PB3.0-P110132	67,90
PZ-WG - Knopf ger. DIN R/L	PB3.0-11015/6	61,90	PB3.0-P11015/6	67,90
PZ-WG - Knopf gekr. DIN R/L	PB3.0-110151/61	65,90	PB3.0-P110151/61	71,90
Drückerpaar				
ohne Rosetten	D11010	25,90	D11010	25,90

Standard-Türstärken: 38 - 42 mm
Aufpreis für Türstärken ab 42 mm: € 5,00

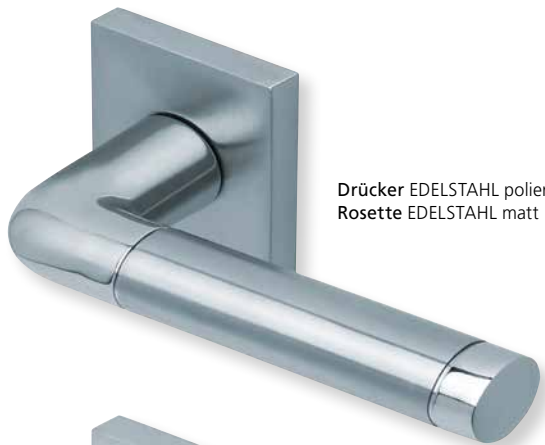

Drücker EDELSTAHL poliert/EDELSTAHL matt
Rosette EDELSTAHL matt



Drücker EDELSTAHL poliert/EDELSTAHL matt
Rosette EDELSTAHL poliert

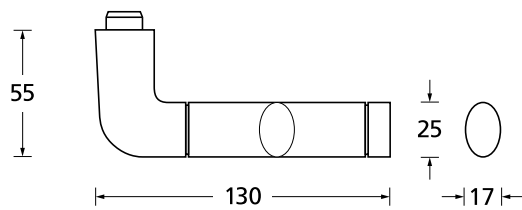



Pullbloc® 3.0 Kugellagertechnik



BB - Garnitur EDELSTAHL poliert



PZ - Garnitur EDELSTAHL poliert



WC - Garnitur EDELSTAHL poliert
WC - Garnitur rot/weiß Anzeige EDELSTAHL poliert
WC - Garnitur rot/grün Anzeige EDELSTAHL poliert



PZ - Wechselgarnitur Knopf gerade EDELSTAHL poliert



RZ - Garnitur EDELSTAHL poliert



PZ - Wechselgarnitur Knopf gekröpft EDELSTAHL poliert

Form 1101 auf Quadratrossette

Rosettengarnitur	Edelstahl matt		Edelstahl poliert	
		€ exkl. MwSt.		€ exkl. MwSt.
BB - Garnitur	PB3.0-Q11010	53,90	PB3.0-QP11010	59,90
PZ - Garnitur	PB3.0-Q11012	53,90	PB3.0-QP11012	59,90
OS - Garnitur (ohne Schlüsselrossette)	PB3.0-Q11010S	49,90	PB3.0-QP11010S	55,90
RZ - Garnitur	PB3.0-Q11018	53,90	PB3.0-QP11018	59,90
WC - Garnitur	PB3.0-Q11013	63,90	PB3.0-QP11013	69,90
WC - Garnitur rot/weiß Anz.	PB3.0-Q110131	67,90	PB3.0-QP110131	73,90
WC - Garnitur rot/grün Anz.	PB3.0-Q110132	67,90	PB3.0-QP110132	73,90
PZ-WG - Knopf ger. DIN R/L	PB3.0-Q11015/6	67,90	PB3.0-QP11015/6	73,90
PZ-WG - Knopf gekr. DIN R/L	PB3.0-Q110151/61	71,90	PB3.0-QP110151/61	77,90
Drückerpaar				
ohne Rosetten	D11010	25,90	D11010	25,90

Standard-Türstärken: 38 - 42 mm
Aufpreis für Türstärken ab 42 mm: € 5,00



Drücker EDELSTAHL matt
Rosette EDELSTAHL matt



Drücker EDELSTAHL poliert
Rosette EDELSTAHL poliert

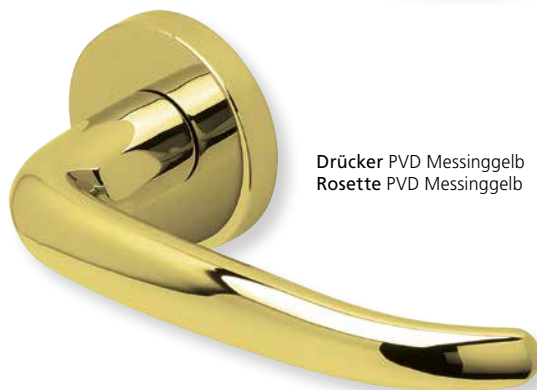

Drücker PVD Messinggelb
Rosette PVD Messinggelb

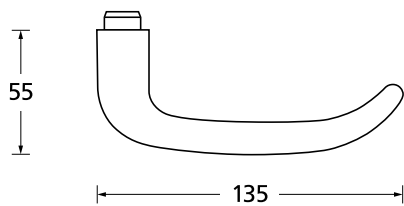



Pullbloc® 3.0 Kugellagertechnik



BB - Garnitur EDELSTAHL matt



PZ - Garnitur EDELSTAHL matt



WC - Garnitur EDELSTAHL matt
WC - Garnitur rot/weiß Anzeige EDELSTAHL matt
WC - Garnitur rot/grün Anzeige EDELSTAHL matt



PZ - Wechselgarnitur Knopf gerade EDELSTAHL matt



RZ - Garnitur EDELSTAHL matt



PZ - Wechselgarnitur Knopf gekröpft EDELSTAHL matt

Form 1103 auf Rundrosette

	Edelstahl matt		Edelstahl poliert		PVD Messinggelb	
	€ exkl. MwSt.		€ exkl. MwSt.		€ exkl. MwSt.	
Rosettengarnitur						
BB - Garnitur	PB3.0-11030	47,90	PB3.0-P11030	57,90	PB3.0-PVM11030	67,90
PZ - Garnitur	PB3.0-11032	47,90	PB3.0-P11032	57,90	PB3.0-PVM11032	67,90
OS - Garnitur (ohne Schlüsselrosette)	PB3.0-1103OS	43,90	PB3.0-P1103OS	53,90	PB3.0-PVM1103OS	63,90
RZ - Garnitur	PB3.0-11038	47,90	PB3.0-P11038	57,90	PB3.0-PVM11038	67,90
WC - Garnitur	PB3.0-11033	57,90	PB3.0-P11033	67,90	PB3.0-PVM11033	77,90
WC - Garnitur rot/weiß Anz.	PB3.0-110331	61,90	PB3.0-P110331	71,90	PB3.0-PVM110331	81,90
WC - Garnitur rot/grün Anz.	PB3.0-110332	61,90	PB3.0-P110332	71,90	PB3.0-PVM110332	81,90
PZ-WG - Knopf ger. DIN R/L	PB3.0-11035/6	61,90	PB3.0-P11035/6	71,90	PB3.0-PVM11035/6	81,90
PZ-WG - Knopf gekr. DIN R/L	PB3.0-110351/61	65,90	PB3.0-P110351/61	75,90	PB3.0-PVM110351/61	85,90
Drückerpaar						
ohne Rosetten	D11030	25,90	DP11030	33,90	DPVM11030	41,90

Standard-Türstärken: 38 - 42 mm
Aufpreis für Türstärken ab 42 mm: € 5,00



Drücker EDELSTAHL matt
Rosette EDELSTAHL matt



Drücker EDELSTAHL poliert
Rosette EDELSTAHL poliert



Drücker PVD Messinggelb
Rosette PVD Messinggelb

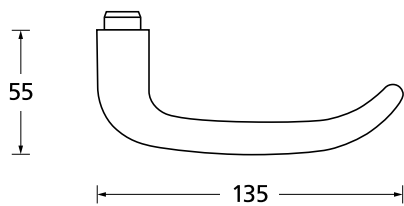



Pullbloc® 3.0 Kugellagertechnik



BB - Garnitur EDELSTAHL poliert



PZ - Garnitur EDELSTAHL poliert



WC - Garnitur EDELSTAHL poliert
WC - Garnitur rot/weiß Anzeige EDELSTAHL poliert
WC - Garnitur rot/grün Anzeige EDELSTAHL poliert



PZ - Wechselgarnitur Knopf gerade
EDELSTAHL poliert



RZ - Garnitur EDELSTAHL poliert



PZ - Wechselgarnitur Knopf gekröpft
EDELSTAHL poliert

Form 1103 auf Quadratrosette

	Edelstahl matt		Edelstahl poliert		PVD Messinggelb	
		€ exkl. MwSt.		€ exkl. MwSt.		€ exkl. MwSt.
Rosettengarnitur						
BB - Garnitur	PB3.0-Q11030	53,90	PB3.0-QP11030	63,90	PB3.0-QPVM11030	73,90
PZ - Garnitur	PB3.0-Q11032	53,90	PB3.0-QP11032	63,90	PB3.0-QPVM11032	73,90
OS - Garnitur (ohne Schlüsselrosette)	PB3.0-Q11030S	49,90	PB3.0-QP11030S	59,90	PB3.0-QPVM11030S	69,90
RZ - Garnitur	PB3.0-Q11038	53,90	PB3.0-QP11038	63,90	PB3.0-QPVM11038	73,90
WC - Garnitur	PB3.0-Q11033	63,90	PB3.0-QP11033	73,90	PB3.0-QPVM11033	83,90
WC - Garnitur rot/weiß Anz.	PB3.0-Q110331	67,90	PB3.0-QP110331	77,90	PB3.0-QPVM110331	87,90
WC - Garnitur rot/grün Anz.	PB3.0-Q110332	67,90	PB3.0-QP110332	77,90	PB3.0-QPVM110332	87,90
PZ-WG - Knopf ger. DIN R/L	PB3.0-Q11035/6	67,90	PB3.0-QP11035/6	77,90	PB3.0-QPVM11035/6	87,90
PZ-WG - Knopf gekr. DIN R/L	PB3.0-Q110351/61	71,90	PB3.0-QP110351/61	81,90	PB3.0-QPVM110351/61	91,90
Drückerpaar						
ohne Rosetten	D11030	25,90	DP11030	33,90	DPVM11030	41,90

Standard-Türstärken: 38 - 42 mm
Aufpreis für Türstärken ab 42 mm: € 5,00



Drücker EDELSTAHL matt
Rosette EDELSTAHL matt



Drücker EDELSTAHL poliert
Rosette EDELSTAHL poliert

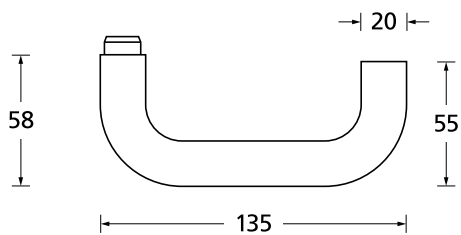



Pullbloc® 3.0 Kugellagertechnik

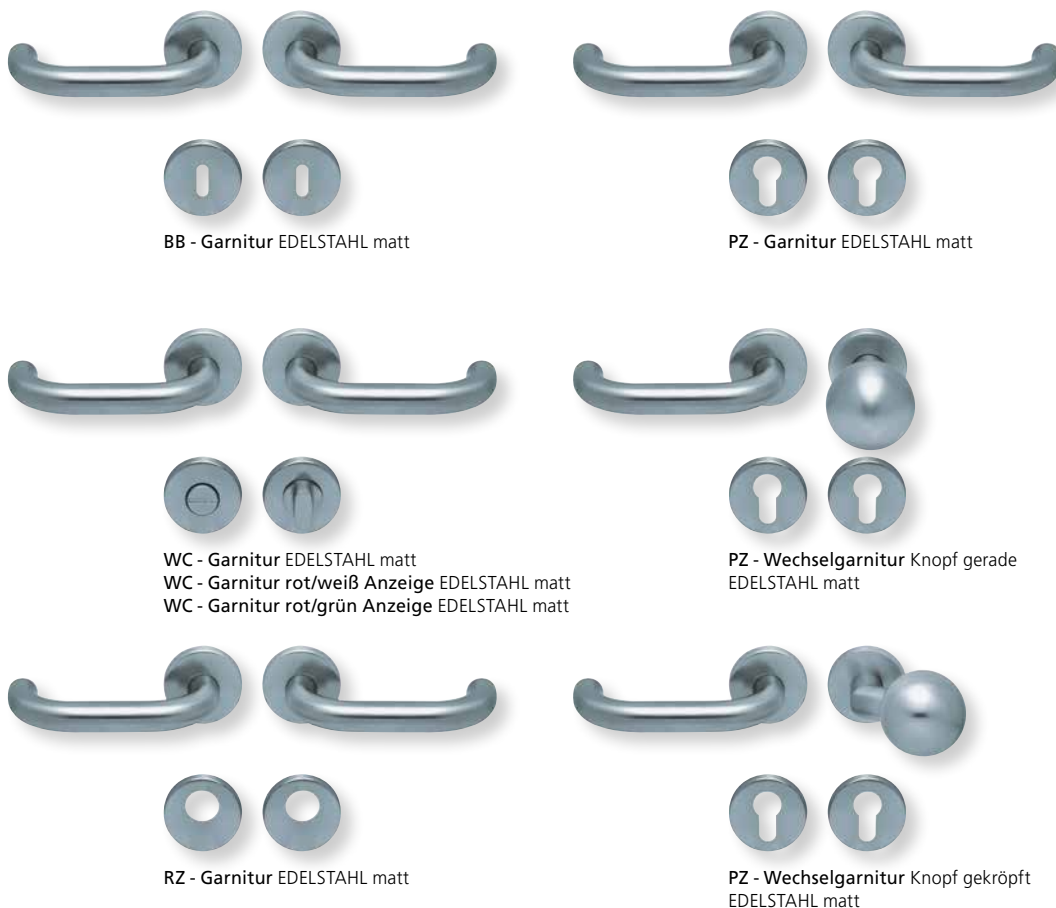

Form 1104 auf Rundrosette

	Edelstahl matt		Edelstahl poliert	
	€ exkl. MwSt.		€ exkl. MwSt.	
Rosettengarnitur				
BB - Garnitur	PB3.0-11040	41,90	PB3.0-P11040	51,90
PZ - Garnitur	PB3.0-11042	41,90	PB3.0-P11042	51,90
OS - Garnitur (ohne Schlüsselrosette)	PB3.0-1104OS	37,90	PB3.0-P1104OS	47,90
RZ - Garnitur	PB3.0-11048	41,90	PB3.0-P11048	51,90
WC - Garnitur	PB3.0-11043	51,90	PB3.0-P11043	61,90
WC - Garnitur rot/weiß Anz.	PB3.0-110431	55,90	PB3.0-P110431	65,90
WC - Garnitur rot/grün Anz.	PB3.0-110432	55,90	PB3.0-P110432	65,90
PZ-WG - Knopf ger. DIN R/L	PB3.0-11045/6	55,90	PB3.0-P11045/6	65,90
PZ-WG - Knopf gekr. DIN R/L	PB3.0-110451/61	59,90	PB3.0-P110451/61	69,90
Drückerpaar				
ohne Rosetten	D11040	19,90	DP11040	27,90

Standard-Türstärken: 38 - 42 mm
Aufpreis für Türstärken ab 42 mm: € 5,00



Drücker EDELSTAHL matt
Rosette EDELSTAHL matt



Drücker EDELSTAHL poliert
Rosette EDELSTAHL poliert

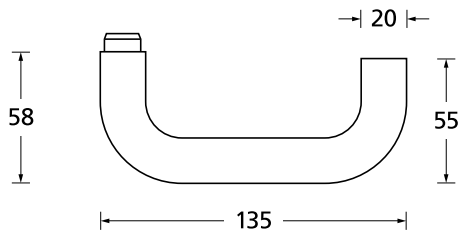



Pullbloc® 3.0 Kugellagertechnik

147



BB - Garnitur EDELSTAHL poliert



PZ - Garnitur EDELSTAHL poliert



WC - Garnitur EDELSTAHL poliert
WC - Garnitur rot/weiß Anzeige EDELSTAHL poliert
WC - Garnitur rot/grün Anzeige EDELSTAHL poliert



PZ - Wechselgarnitur Knopf gerade EDELSTAHL poliert



RZ - Garnitur EDELSTAHL poliert



PZ - Wechselgarnitur Knopf gekröpft EDELSTAHL poliert

Form 1104 auf Quadratrosette

	Edelstahl matt		Edelstahl poliert	
		€ exkl. MwSt.		€ exkl. MwSt.
Rosettengarnitur				
BB - Garnitur	PB3.0-Q11040	47,90	PB3.0-QP11040	57,90
PZ - Garnitur	PB3.0-Q11042	47,90	PB3.0-QP11042	57,90
OS - Garnitur (ohne Schlüsselrosette)	PB3.0-Q1104OS	43,90	PB3.0-QP1104OS	53,90
RZ - Garnitur	PB3.0-Q11048	47,90	PB3.0-QP11048	57,90
WC - Garnitur	PB3.0-Q11043	57,90	PB3.0-QP11043	67,90
WC - Garnitur rot/weiß Anz.	PB3.0-Q110431	61,90	PB3.0-QP110431	71,90
WC - Garnitur rot/grün Anz.	PB3.0-Q110432	61,90	PB3.0-QP110432	71,90
PZ-WG - Knopf ger. DIN R/L	PB3.0-Q11045/6	61,90	PB3.0-QP11045/6	71,90
PZ-WG - Knopf gekr. DIN R/L	PB3.0-Q110451/61	65,90	PB3.0-QP110451/61	75,90
Drückerpaar				
ohne Rosetten	D11040	19,90	DP11040	27,90

Standard-Türstärken: 38 - 42 mm
Aufpreis für Türstärken ab 42 mm: € 5,00



Drücker EDELSTAHL matt
Rosette EDELSTAHL matt



Drücker EDELSTAHL poliert
Rosette EDELSTAHL poliert

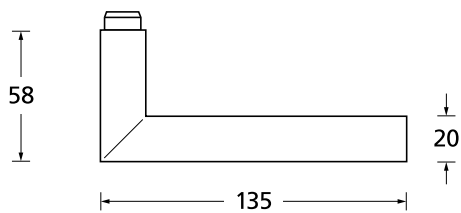



Pullbloc® 3.0 Kugellagertechnik

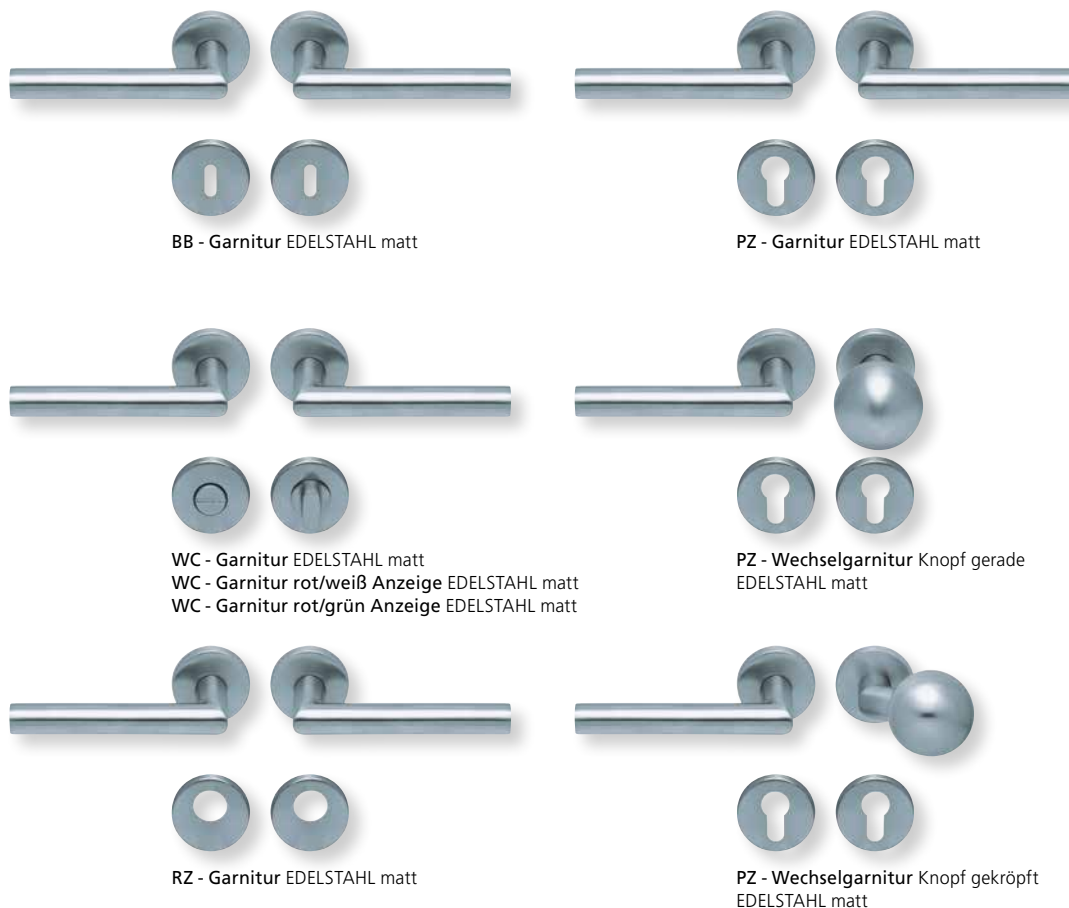

Form 1106 auf Rundrosette

Rosettengarnitur	Edelstahl matt		Edelstahl poliert	
		€ exkl. MwSt.		€ exkl. MwSt.
BB - Garnitur	PB3.0-11060	41,90	PB3.0-P11060	51,90
PZ - Garnitur	PB3.0-11062	41,90	PB3.0-P11062	51,90
OS - Garnitur (ohne Schlüsselrosette)	PB3.0-1106OS	37,90	PB3.0-P1106OS	47,90
RZ - Garnitur	PB3.0-11068	41,90	PB3.0-P11068	51,90
WC - Garnitur	PB3.0-11063	51,90	PB3.0-P11063	61,90
WC - Garnitur rot/weiß Anz.	PB3.0-110631	55,90	PB3.0-P110631	65,90
WC - Garnitur rot/grün Anz.	PB3.0-110632	55,90	PB3.0-P110632	65,90
PZ-WG - Knopf ger. DIN R/L	PB3.0-11065/6	55,90	PB3.0-P11065/6	65,90
PZ-WG - Knopf gekr. DIN R/L	PB3.0-110651/61	59,90	PB3.0-P110651/61	69,90
Drückerpaar				
ohne Rosetten	D11060	19,90	DP11060	27,90

Standard-Türstärken: 38 - 42 mm
Aufpreis für Türstärken ab 42 mm: € 5,00

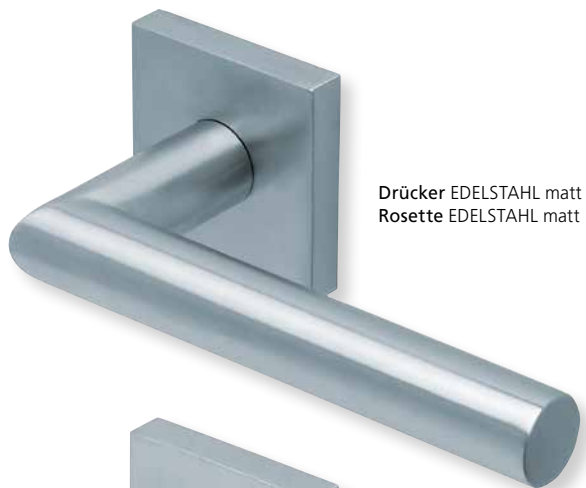

Drücker EDELSTAHL matt
Rosette EDELSTAHL matt



Drücker EDELSTAHL poliert
Rosette EDELSTAHL poliert

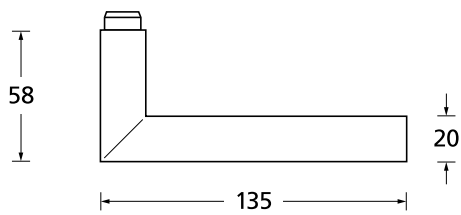



Pullbloc® 3.0 Kugellagertechnik



BB - Garnitur EDELSTAHL poliert



PZ - Garnitur EDELSTAHL poliert



WC - Garnitur EDELSTAHL poliert
WC - Garnitur rot/weiß Anzeige EDELSTAHL poliert
WC - Garnitur rot/grün Anzeige EDELSTAHL poliert



PZ - Wechselgarnitur Knopf gerade
EDELSTAHL poliert



RZ - Garnitur EDELSTAHL poliert



PZ - Wechselgarnitur Knopf gekröpft
EDELSTAHL poliert

Form 1106 auf Quadratrosette

	Edelstahl matt		Edelstahl poliert	
		€ exkl. MwSt.		€ exkl. MwSt.
Rosettengarnitur				
BB - Garnitur	PB3.0-Q11060	47,90	PB3.0-QP11060	57,90
PZ - Garnitur	PB3.0-Q11062	47,90	PB3.0-QP11062	57,90
OS - Garnitur (ohne Schlüsselrosette)	PB3.0-Q1106OS	43,90	PB3.0-QP1106OS	53,90
RZ - Garnitur	PB3.0-Q11068	47,90	PB3.0-QP11068	57,90
WC - Garnitur	PB3.0-Q11063	57,90	PB3.0-QP11063	67,90
WC - Garnitur rot/weiß Anz.	PB3.0-Q110631	61,90	PB3.0-QP110631	71,90
WC - Garnitur rot/grün Anz.	PB3.0-Q110632	61,90	PB3.0-QP110632	71,90
PZ-WG - Knopf ger. DIN R/L	PB3.0-Q11065/6	61,90	PB3.0-QP11065/6	71,90
PZ-WG - Knopf gekr. DIN R/L	PB3.0-Q110651/61	65,90	PB3.0-QP110651/61	75,90
Drückerpaar				
ohne Rosetten	D11060	19,90	DP11060	27,90

Standard-Türstärken: 38 - 42 mm
Aufpreis für Türstärken ab 42 mm: € 5,00



Drücker EDELSTAHL matt
Rosette EDELSTAHL matt



Drücker EDELSTAHL poliert
Rosette EDELSTAHL poliert

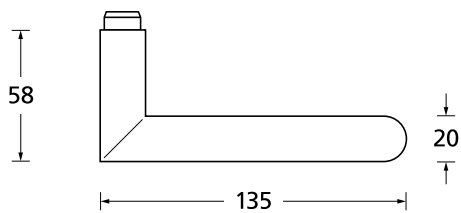



Pullbloc® 3.0 Kugellagertechnik

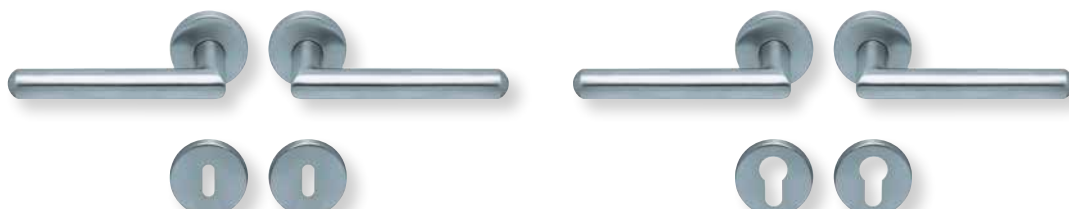

BB - Garnitur EDELSTAHL matt

PZ - Garnitur EDELSTAHL matt

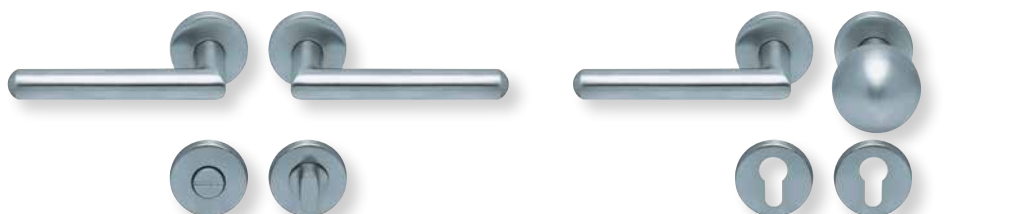

WC - Garnitur EDELSTAHL matt
WC - Garnitur rot/weiß Anzeige EDELSTAHL matt
WC - Garnitur rot/grün Anzeige EDELSTAHL matt

PZ - Wechselgarnitur Knopf gerade EDELSTAHL matt

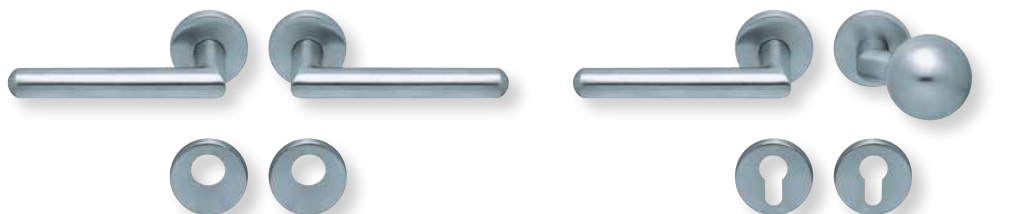

RZ - Garnitur EDELSTAHL matt

PZ - Wechselgarnitur Knopf gekröpft EDELSTAHL matt

Form 1107 auf Rundrosette

Rosettengarnitur	Edelstahl matt		Edelstahl poliert	
		€ exkl. MwSt.		€ exkl. MwSt.
BB - Garnitur	PB3.0-11070	41,90	PB3.0-P11070	51,90
PZ - Garnitur	PB3.0-11072	41,90	PB3.0-P11072	51,90
OS - Garnitur (ohne Schlüsselrosette)	PB3.0-1107OS	37,90	PB3.0-P1107OS	47,90
RZ - Garnitur	PB3.0-11078	41,90	PB3.0-P11078	51,90
WC - Garnitur	PB3.0-11073	51,90	PB3.0-P11073	61,90
WC - Garnitur rot/weiß Anz.	PB3.0-110731	55,90	PB3.0-P110731	65,90
WC - Garnitur rot/grün Anz.	PB3.0-110732	55,90	PB3.0-P110732	65,90
PZ-WG - Knopf ger. DIN R/L	PB3.0-11075/6	55,90	PB3.0-P11075/6	65,90
PZ-WG - Knopf gekr. DIN R/L	PB3.0-110751/61	59,90	PB3.0-P110751/61	69,90
Drückerpaar				
ohne Rosetten	D11070	19,90	DP11070	27,90

Standard-Türstärken: 38 - 42 mm
Aufpreis für Türstärken ab 42 mm: € 5,00

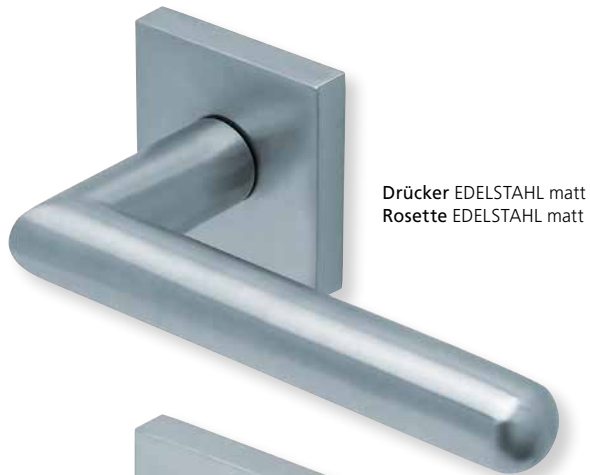

Drücker EDELSTAHL matt
Rosette EDELSTAHL matt



Drücker EDELSTAHL poliert
Rosette EDELSTAHL poliert

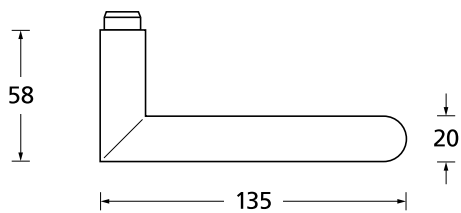



Pullbloc® 3.0 Kugellagertechnik



BB - Garnitur EDELSTAHL poliert



PZ - Garnitur EDELSTAHL poliert



WC - Garnitur EDELSTAHL poliert
WC - Garnitur rot/weiß Anzeige EDELSTAHL poliert
WC - Garnitur rot/grün Anzeige EDELSTAHL poliert



PZ - Wechselgarnitur Knopf gerade EDELSTAHL poliert



RZ - Garnitur EDELSTAHL poliert



PZ - Wechselgarnitur Knopf gekröpft EDELSTAHL poliert

Form 1107 auf Quadratrosette

	Edelstahl matt		Edelstahl poliert	
		€ exkl. MwSt.		€ exkl. MwSt.
Rosettengarnitur				
BB - Garnitur	PB3.0-Q11070	47,90	PB3.0-QP11070	57,90
PZ - Garnitur	PB3.0-Q11072	47,90	PB3.0-QP11072	57,90
OS - Garnitur (ohne Schlüsselrosette)	PB3.0-Q11070S	43,90	PB3.0-QP11070S	53,90
RZ - Garnitur	PB3.0-Q11078	47,90	PB3.0-QP11078	57,90
WC - Garnitur	PB3.0-Q11073	57,90	PB3.0-QP11073	67,90
WC - Garnitur rot/weiß Anz.	PB3.0-Q110731	61,90	PB3.0-QP110731	71,90
WC - Garnitur rot/grün Anz.	PB3.0-Q110732	61,90	PB3.0-QP110732	71,90
PZ-WG - Knopf ger. DIN R/L	PB3.0-Q11075/6	61,90	PB3.0-QP11075/6	71,90
PZ-WG - Knopf gekr. DIN R/L	PB3.0-Q110751/61	65,90	PB3.0-QP110751/61	75,90
Drückerpaar				
ohne Rosetten	D11070	19,90	DP11070	27,90

Standard-Türstärken: 38 - 42 mm
Aufpreis für Türstärken ab 42 mm: € 5,00



Drücker EDELSTAHL matt
Rosette EDELSTAHL matt



Drücker EDELSTAHL poliert
Rosette EDELSTAHL poliert

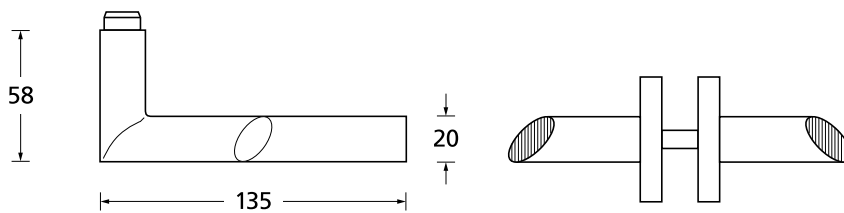



Pullbloc® 3.0 Kugellagertechnik

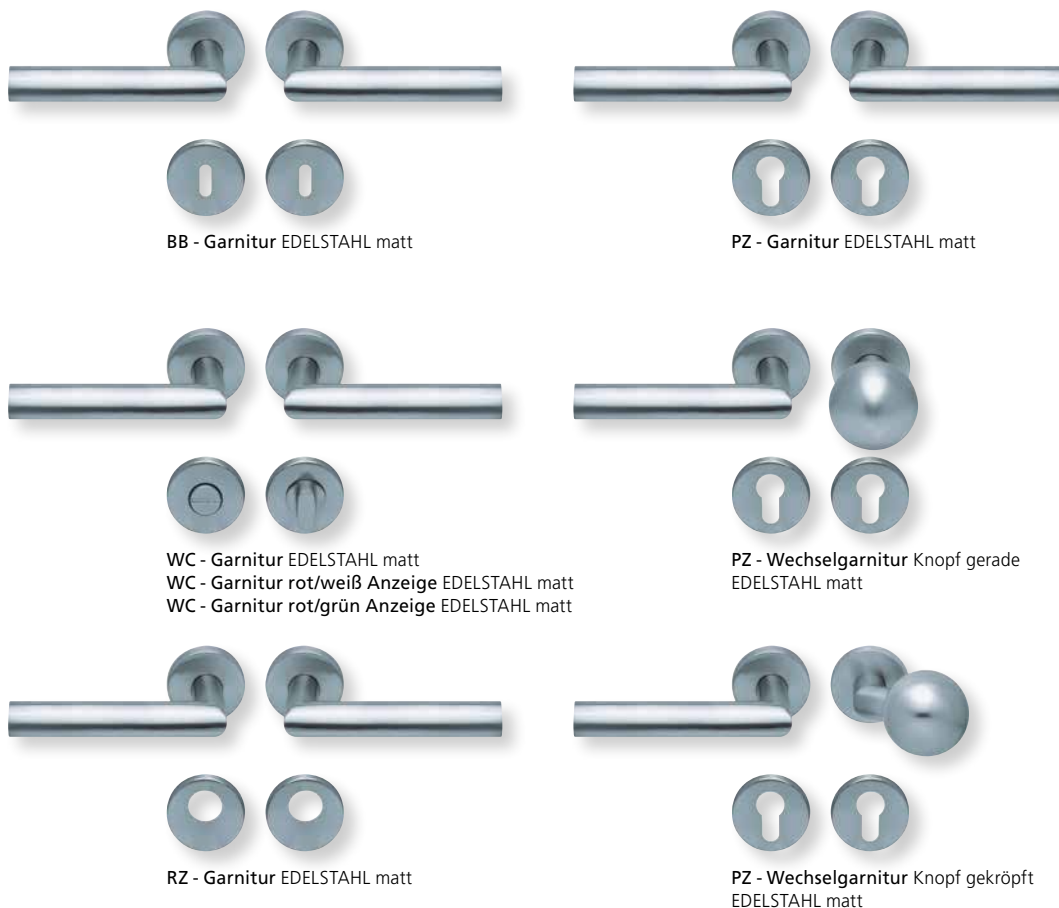

Form 1108 auf Rundrosette

	Edelstahl matt		Edelstahl poliert	
		€ exkl. MwSt.		€ exkl. MwSt.
Rosettengarnitur				
BB - Garnitur	PB3.0-11080	41,90	PB3.0-P11080	51,90
PZ - Garnitur	PB3.0-11082	41,90	PB3.0-P11082	51,90
OS - Garnitur (ohne Schlüsselrosette)	PB3.0-1108OS	37,90	PB3.0-P1108OS	47,90
RZ - Garnitur	PB3.0-11088	41,90	PB3.0-P11088	51,90
WC - Garnitur	PB3.0-11083	51,90	PB3.0-P11083	61,90
WC - Garnitur rot/weiß Anz.	PB3.0-110831	55,90	PB3.0-P110831	65,90
WC - Garnitur rot/grün Anz.	PB3.0-110832	55,90	PB3.0-P110832	65,90
PZ-WG - Knopf ger. DIN R/L	PB3.0-11086/7	55,90	PB3.0-P11086/7	65,90
PZ-WG - Knopf gekr. DIN R/L	PB3.0-110861/71	59,90	PB3.0-P110861/71	69,90
Drückerpaar				
ohne Rosetten	D11080	19,90	DP11080	27,90

Standard-Türstärken: 38 - 42 mm
 Aufpreis für Türstärken ab 42 mm: € 5,00

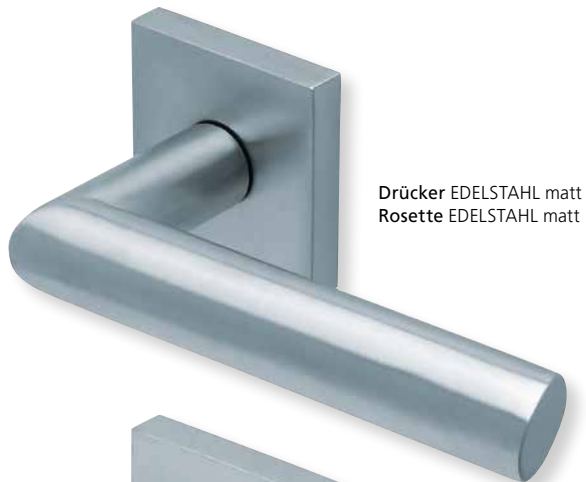

Drücker EDELSTAHL matt
Rosette EDELSTAHL matt

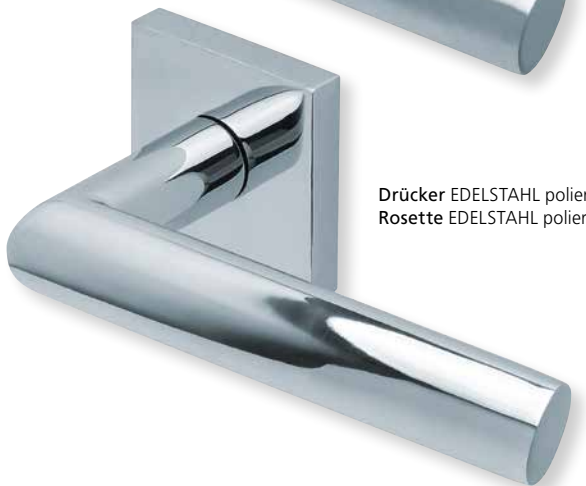

Drücker EDELSTAHL poliert
Rosette EDELSTAHL poliert

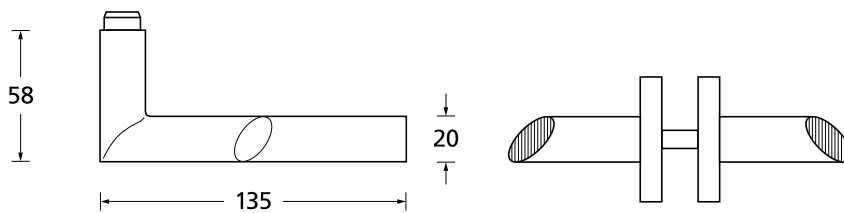



Pullbloc® 3.0 Kugellagertechnik



BB - Garnitur EDELSTAHL poliert



PZ - Garnitur EDELSTAHL poliert



WC - Garnitur EDELSTAHL poliert
WC - Garnitur rot/weiß Anzeige EDELSTAHL poliert
WC - Garnitur rot/grün Anzeige EDELSTAHL poliert



PZ - Wechselgarnitur Knopf gerade EDELSTAHL poliert



RZ - Garnitur EDELSTAHL poliert



PZ - Wechselgarnitur Knopf gekröpft EDELSTAHL poliert

Form 1108 auf Quadratrosette

	Edelstahl matt		Edelstahl poliert	
		€ exkl. MwSt.		€ exkl. MwSt.
Rosettengarnitur				
BB - Garnitur	PB3.0-Q11080	47,90	PB3.0-QP11080	57,90
PZ - Garnitur	PB3.0-Q11082	47,90	PB3.0-QP11082	57,90
OS - Garnitur (ohne Schlüsselrosette)	PB3.0-Q1108OS	43,90	PB3.0-QP1108OS	53,90
RZ - Garnitur	PB3.0-Q11088	47,90	PB3.0-QP11088	57,90
WC - Garnitur	PB3.0-Q11083	57,90	PB3.0-QP11083	67,90
WC - Garnitur rot/weiß Anz.	PB3.0-Q110831	61,90	PB3.0-QP110831	71,90
WC - Garnitur rot/grün Anz.	PB3.0-Q110832	61,90	PB3.0-QP110832	71,90
PZ-WG - Knopf ger. DIN R/L	PB3.0-Q11086/7	61,90	PB3.0-QP11086/7	71,90
PZ-WG - Knopf gekr. DIN R/L	PB3.0-Q110861/71	65,90	PB3.0-QP110861/71	75,90
Drückerpaar				
ohne Rosetten	D11080	19,90	DP11080	27,90

Standard-Türstärken: 38 - 42 mm
Aufpreis für Türstärken ab 42 mm: € 5,00



Drücker EDELSTAHL matt
Rosette EDELSTAHL matt



Drücker EDELSTAHL poliert
Rosette EDELSTAHL poliert

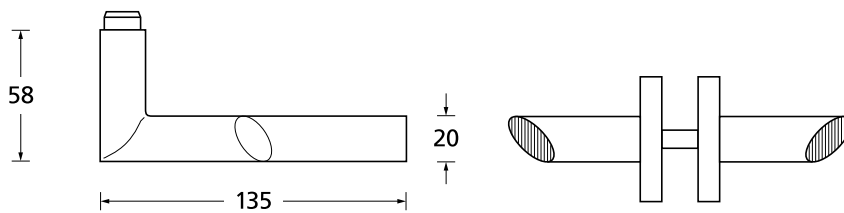



Pullbloc® 3.0 Kugellagertechnik

161

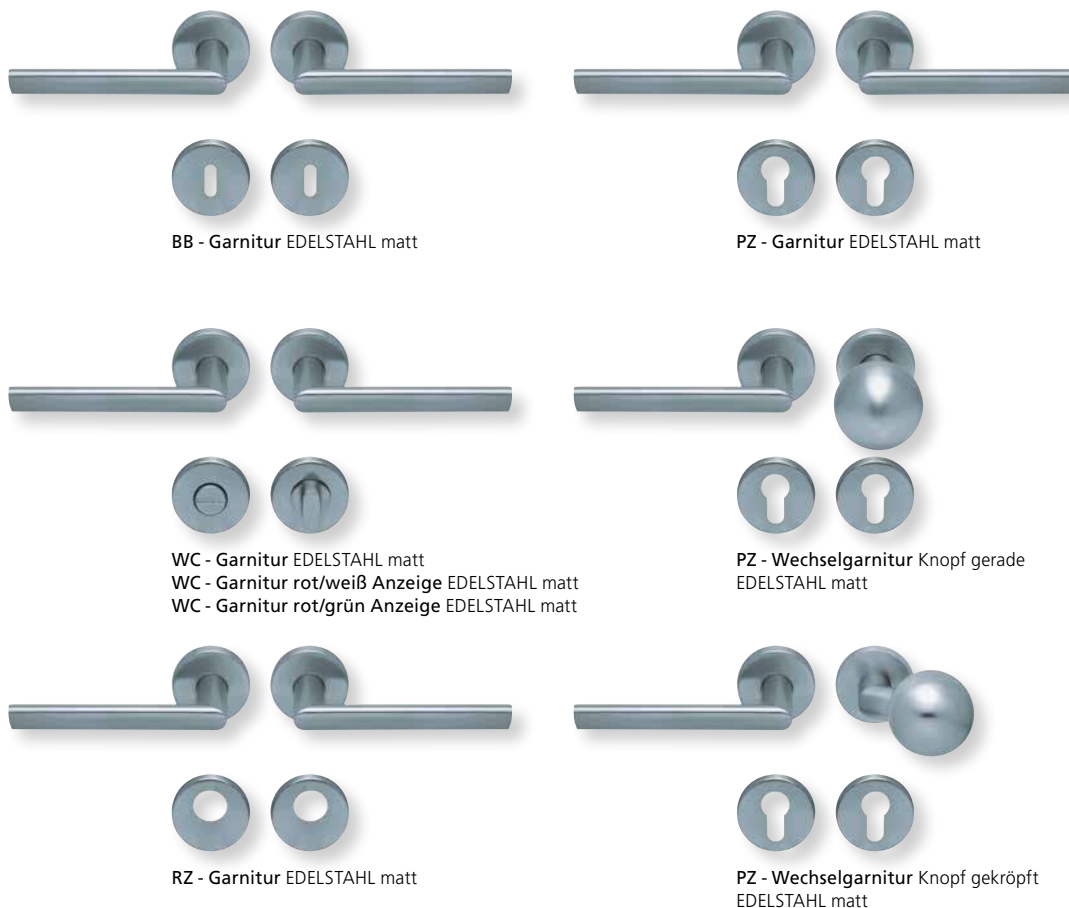

Form 1109 auf Rundrosette

	Edelstahl matt		Edelstahl poliert	
	€ exkl. MwSt.		€ exkl. MwSt.	
Rosettengarnitur				
BB - Garnitur	PB3.0-11090	41,90	PB3.0-P11090	51,90
PZ - Garnitur	PB3.0-11092	41,90	PB3.0-P11092	51,90
OS - Garnitur (ohne Schlüsselrosette)	PB3.0-1109OS	37,90	PB3.0-P1109OS	47,90
RZ - Garnitur	PB3.0-11098	41,90	PB3.0-P11098	51,90
WC - Garnitur	PB3.0-11093	51,90	PB3.0-P11093	61,90
WC - Garnitur rot/weiß Anz.	PB3.0-110931	55,90	PB3.0-P110931	65,90
WC - Garnitur rot/grün Anz.	PB3.0-110932	55,90	PB3.0-P110932	65,90
PZ-WG - Knopf ger. DIN R/L	PB3.0-11096/7	55,90	PB3.0-P11096/7	65,90
PZ-WG - Knopf gekr. DIN R/L	PB3.0-110961/71	59,90	PB3.0-P110961/71	69,90
Drückerpaar				
ohne Rosetten	D11090	19,90	DP11090	27,90

Standard-Türstärken: 38 - 42 mm
 Aufpreis für Türstärken ab 42 mm: € 5,00

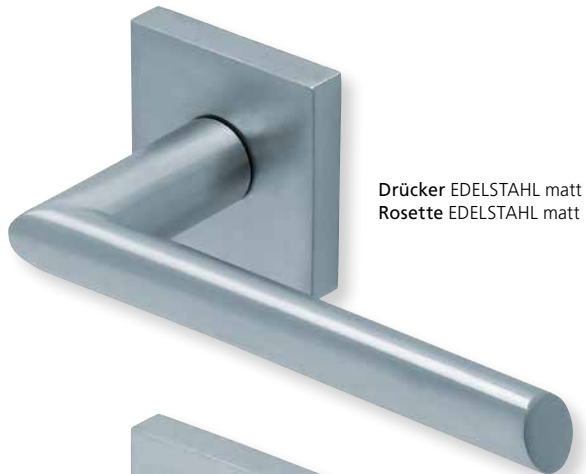

Drücker EDELSTAHL matt
Rosette EDELSTAHL matt



Drücker EDELSTAHL poliert
Rosette EDELSTAHL poliert

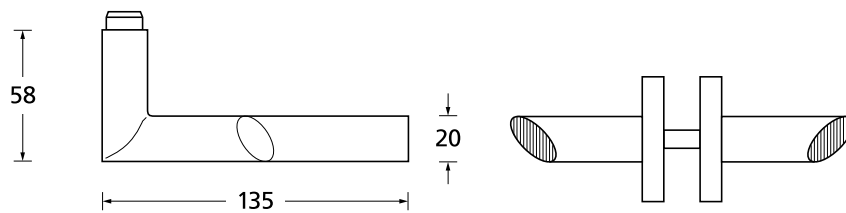



Pullbloc® 3.0 Kugellagertechnik

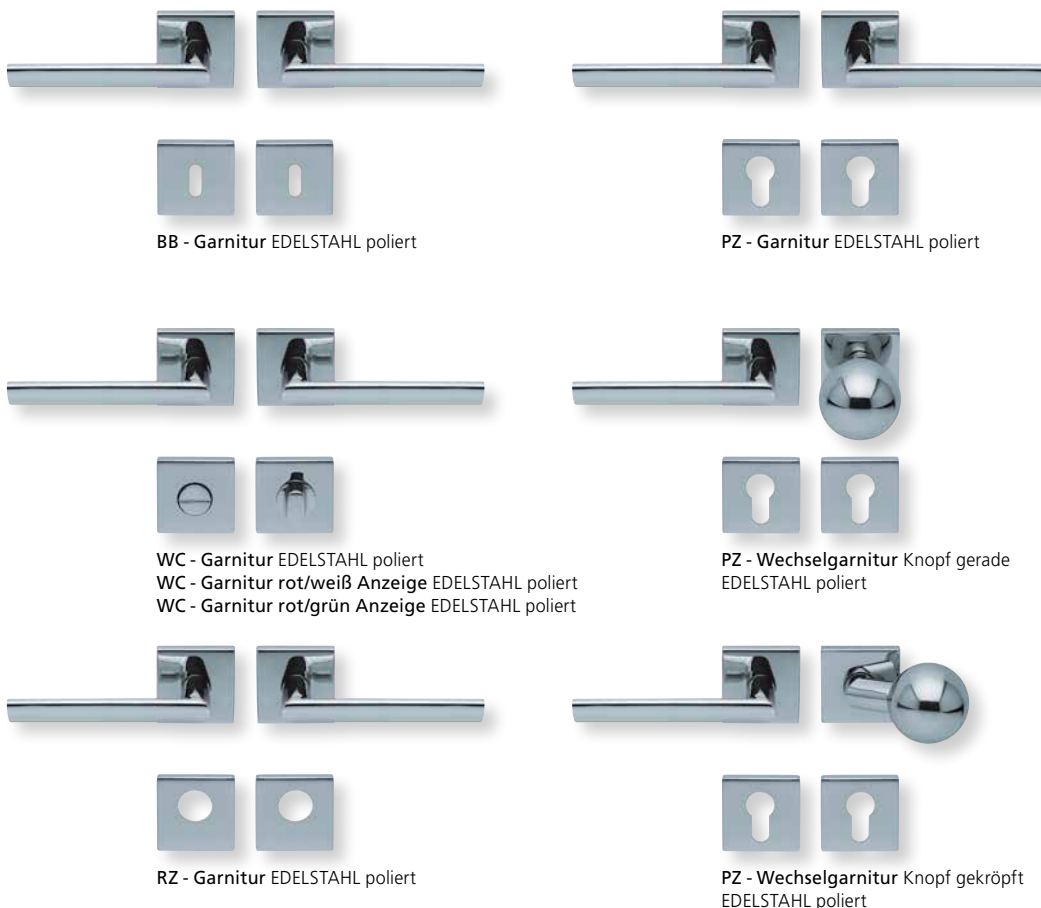

BB - Garnitur EDELSTAHL poliert

PZ - Garnitur EDELSTAHL poliert

WC - Garnitur EDELSTAHL poliert
WC - Garnitur rot/weiß Anzeige EDELSTAHL poliert
WC - Garnitur rot/grün Anzeige EDELSTAHL poliert

PZ - Wechselgarnitur Knopf gerade EDELSTAHL poliert

RZ - Garnitur EDELSTAHL poliert

PZ - Wechselgarnitur Knopf gekröpft EDELSTAHL poliert

Form 1109 auf Quadratrosette

Rosettengarnitur	Edelstahl matt		Edelstahl poliert	
		€ exkl. MwSt.		€ exkl. MwSt.
BB - Garnitur	PB3.0-Q11090	47,90	PB3.0-QP11090	57,90
PZ - Garnitur	PB3.0-Q11092	47,90	PB3.0-QP11092	57,90
OS - Garnitur (ohne Schlüsselrosette)	PB3.0-Q1109OS	43,90	PB3.0-QP1109OS	53,90
RZ - Garnitur	PB3.0-Q11098	47,90	PB3.0-QP11098	57,90
WC - Garnitur	PB3.0-Q11093	57,90	PB3.0-QP11093	67,90
WC - Garnitur rot/weiß Anz.	PB3.0-Q110931	61,90	PB3.0-QP110931	71,90
WC - Garnitur rot/grün Anz.	PB3.0-Q110932	61,90	PB3.0-QP110932	71,90
PZ-WG - Knopf ger. DIN R/L	PB3.0-Q11096/7	61,90	PB3.0-QP11096/7	71,90
PZ-WG - Knopf gekr. DIN R/L	PB3.0-Q110961/71	65,90	PB3.0-QP110961/71	75,90
Drückerpaar				
ohne Rosetten	D11090	19,90	DP11090	27,90

Standard-Türstärken: 38 - 42 mm
Aufpreis für Türstärken ab 42 mm: € 5,00

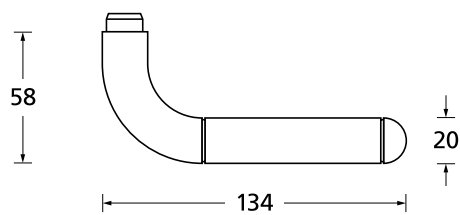



Pullbloc® 3.0 Kugellagertechnik



BB - Garnitur EDELSTAHL poliert



PZ - Garnitur EDELSTAHL poliert



WC - Garnitur EDELSTAHL poliert
WC - Garnitur rot/weiß Anzeige EDELSTAHL poliert
WC - Garnitur rot/grün Anzeige EDELSTAHL poliert



PZ - Wechselgarnitur Knopf gerade EDELSTAHL poliert



RZ - Garnitur EDELSTAHL poliert



PZ - Wechselgarnitur Knopf gekröpft EDELSTAHL poliert

Form 1173 auf Rundrosette

Rosettengarnitur	Edelstahl matt		Edelstahl poliert	
		€ exkl. MwSt.		€ exkl. MwSt.
BB - Garnitur	PB3.0-11730	43,90	PB3.0-P11730	49,90
PZ - Garnitur	PB3.0-11732	43,90	PB3.0-P11732	49,90
OS - Garnitur (ohne Schlüsselrosette)	PB3.0-1173OS	39,90	PB3.0-P1173OS	45,90
RZ - Garnitur	PB3.0-11738	43,90	PB3.0-P11738	49,90
WC - Garnitur	PB3.0-11733	53,90	PB3.0-P11733	59,90
WC - Garnitur rot/weiß Anz.	PB3.0-117331	57,90	PB3.0-P117331	63,90
WC - Garnitur rot/grün Anz.	PB3.0-117332	57,90	PB3.0-P117332	63,90
PZ-WG - Knopf ger. DIN R/L	PB3.0-11736/7	57,90	PB3.0-P11736/7	63,90
PZ-WG - Knopf gekr. DIN R/L	PB3.0-117361/71	61,90	PB3.0-P117361/71	67,90
Drückerpaar				
ohne Rosetten	D11730	21,90	D11730	21,90

Standard-Türstärken: 38 - 42 mm
Aufpreis für Türstärken ab 42 mm: € 5,00



Drücker EDELSTAHL poliert/EDELSTAHL matt
Rosette EDELSTAHL matt

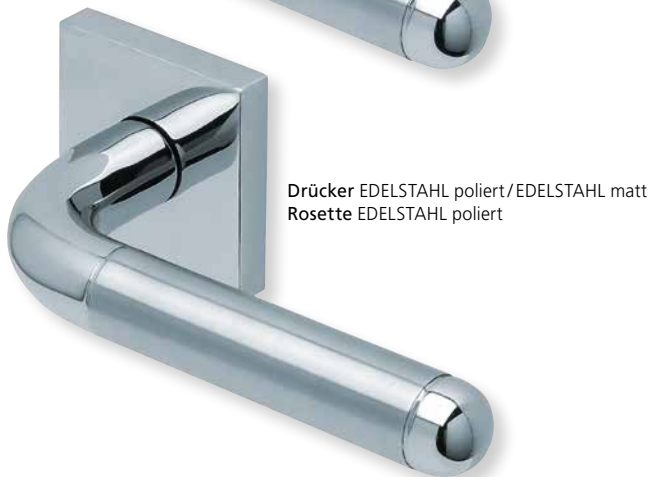

Drücker EDELSTAHL poliert/EDELSTAHL matt
Rosette EDELSTAHL poliert

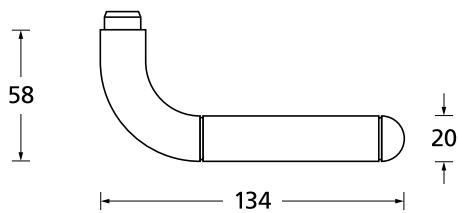



Pullbloc® 3.0 Kugellagertechnik



BB - Garnitur EDELSTAHL poliert



PZ - Garnitur EDELSTAHL poliert



WC - Garnitur EDELSTAHL poliert
WC - Garnitur rot/weiß Anzeige EDELSTAHL poliert
WC - Garnitur rot/grün Anzeige EDELSTAHL poliert



PZ - Wechselgarnitur Knopf gerade EDELSTAHL poliert



RZ - Garnitur EDELSTAHL poliert



PZ - Wechselgarnitur Knopf gekröpft EDELSTAHL poliert

Form 1173 auf Quadratrosette

Rosettengarnitur	Edelstahl matt		Edelstahl poliert	
		€ exkl. MwSt.		€ exkl. MwSt.
BB - Garnitur	PB3.0-Q11730	49,90	PB3.0-QP11730	55,90
PZ - Garnitur	PB3.0-Q11732	49,90	PB3.0-QP11732	55,90
OS - Garnitur (ohne Schlüsselrosette)	PB3.0-Q11730S	45,90	PB3.0-QP11730S	51,90
RZ - Garnitur	PB3.0-Q11738	49,90	PB3.0-QP11738	55,90
WC - Garnitur	PB3.0-Q11733	59,90	PB3.0-QP11733	65,90
WC - Garnitur rot/weiß Anz.	PB3.0-Q117331	63,90	PB3.0-QP117331	69,90
WC - Garnitur rot/grün Anz.	PB3.0-Q117332	63,90	PB3.0-QP117332	69,90
PZ-WG - Knopf ger. DIN R/L	PB3.0-Q11736/7	63,90	PB3.0-QP11736/7	69,90
PZ-WG - Knopf gekr. DIN R/L	PB3.0-Q117361/71	67,90	PB3.0-QP117361/71	73,90
Drückerpaar				
ohne Rosetten	D11730	21,90	D11730	21,90

Standard-Türstärken: 38 - 42 mm
Aufpreis für Türstärken ab 42 mm: € 5,00



Drücker EDELSTAHL poliert/EDELSTAHL matt
Rosette EDELSTAHL matt



Drücker EDELSTAHL poliert/EDELSTAHL matt
Rosette EDELSTAHL poliert

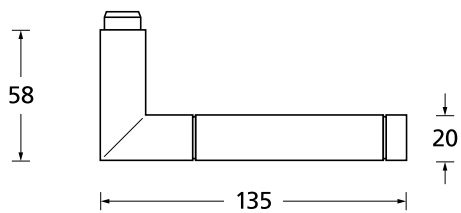



Pullbloc® 3.0 Kugellagertechnik

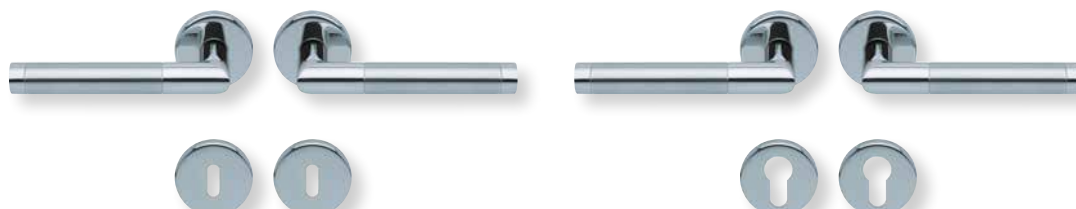

BB - Garnitur EDELSTAHL poliert

PZ - Garnitur EDELSTAHL poliert

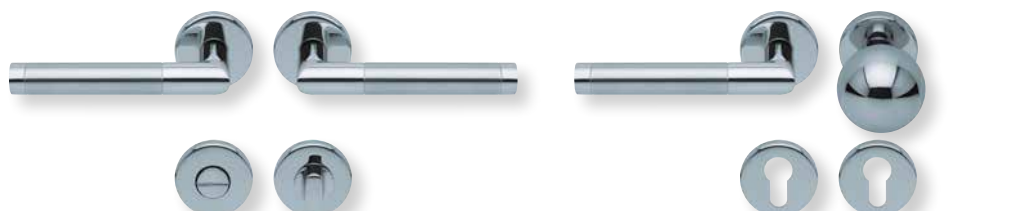

WC - Garnitur EDELSTAHL poliert
WC - Garnitur rot/weiß Anzeige EDELSTAHL poliert
WC - Garnitur rot/grün Anzeige EDELSTAHL poliert

PZ - Wechselgarnitur Knopf gerade EDELSTAHL poliert

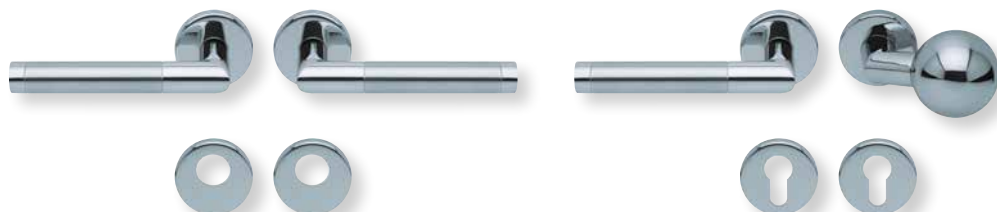

RZ - Garnitur EDELSTAHL poliert

PZ - Wechselgarnitur Knopf gekröpft EDELSTAHL poliert

Form 1174 auf Rundrosette

	Edelstahl matt		Edelstahl poliert	
		€ exkl. MwSt.		€ exkl. MwSt.
Rosettengarnitur				
BB - Garnitur	PB3.0-11740	43,90	PB3.0-P11740	49,90
PZ - Garnitur	PB3.0-11742	43,90	PB3.0-P11742	49,90
OS - Garnitur (ohne Schlüsselrosette)	PB3.0-1174OS	39,90	PB3.0-P1174OS	45,90
RZ - Garnitur	PB3.0-11748	43,90	PB3.0-P11748	49,90
WC - Garnitur	PB3.0-11743	53,90	PB3.0-P11743	59,90
WC - Garnitur rot/weiß Anz.	PB3.0-117431	57,90	PB3.0-P117431	63,90
WC - Garnitur rot/grün Anz.	PB3.0-117432	57,90	PB3.0-P117432	63,90
PZ-WG - Knopf ger. DIN R/L	PB3.0-11746/7	57,90	PB3.0-P11746/7	63,90
PZ-WG - Knopf gekr. DIN R/L	PB3.0-117461/71	61,90	PB3.0-P117461/71	67,90
Drückerpaar				
ohne Rosetten	D11740	21,90	D11740	21,90

Standard-Türstärken: 38 - 42 mm
Aufpreis für Türstärken ab 42 mm: € 5,00



Drücker EDELSTAHL poliert/EDELSTAHL matt
Rosette EDELSTAHL matt

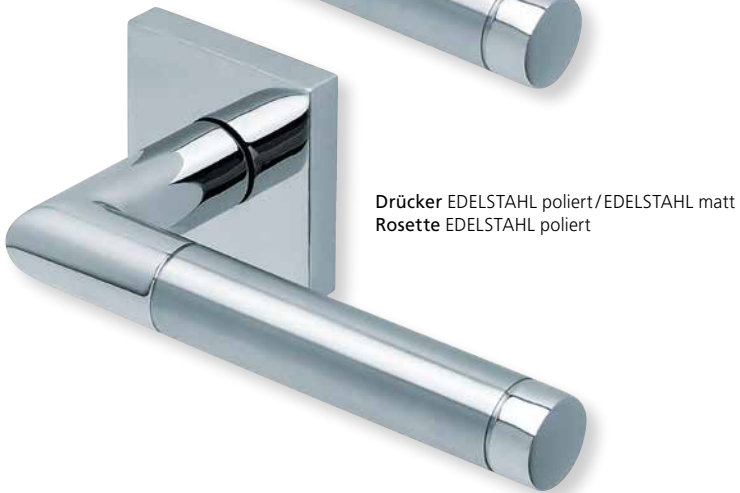

Drücker EDELSTAHL poliert/EDELSTAHL matt
Rosette EDELSTAHL poliert

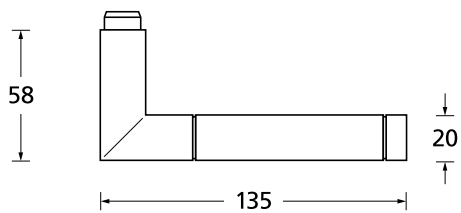



Pullbloc® 3.0 Kugellagertechnik



BB - Garnitur EDELSTAHL poliert



PZ - Garnitur EDELSTAHL poliert



WC - Garnitur EDELSTAHL poliert
WC - Garnitur rot/weiß Anzeige EDELSTAHL poliert
WC - Garnitur rot/grün Anzeige EDELSTAHL poliert



PZ - Wechselgarnitur Knopf gerade
EDELSTAHL poliert



RZ - Garnitur EDELSTAHL poliert



PZ - Wechselgarnitur Knopf gekröpft
EDELSTAHL poliert

Form 1174 auf Quadratrosette

	Edelstahl matt		Edelstahl poliert	
		€ exkl. MwSt.		€ exkl. MwSt.
Rosettengarnitur				
BB - Garnitur	PB3.0-Q11740	49,90	PB3.0-QP11740	55,90
PZ - Garnitur	PB3.0-Q11742	49,90	PB3.0-QP11742	55,90
OS - Garnitur (ohne Schlüsselrosette)	PB3.0-Q11740S	45,90	PB3.0-QP11740S	51,90
RZ - Garnitur	PB3.0-Q11748	49,90	PB3.0-QP11748	55,90
WC - Garnitur	PB3.0-Q11743	59,90	PB3.0-QP11743	65,90
WC - Garnitur rot/weiß Anz.	PB3.0-Q117431	63,90	PB3.0-QP117431	69,90
WC - Garnitur rot/grün Anz.	PB3.0-Q117432	63,90	PB3.0-QP117432	69,90
PZ-WG - Knopf ger. DIN R/L	PB3.0-Q11746/7	63,90	PB3.0-QP11746/7	69,90
PZ-WG - Knopf gekr. DIN R/L	PB3.0-Q117461/71	67,90	PB3.0-QP117461/71	73,90
Drückerpaar				
ohne Rosetten	D11740	21,90	D11740	21,90

Standard-Türstärken: 38 - 42 mm
Aufpreis für Türstärken ab 42 mm: € 5,00



Drücker EDELSTAHL matt
Rosette EDELSTAHL matt



Drücker EDELSTAHL poliert
Rosette EDELSTAHL poliert

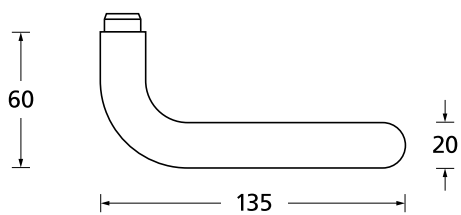



Pullbloc® 3.0 Kugellagertechnik

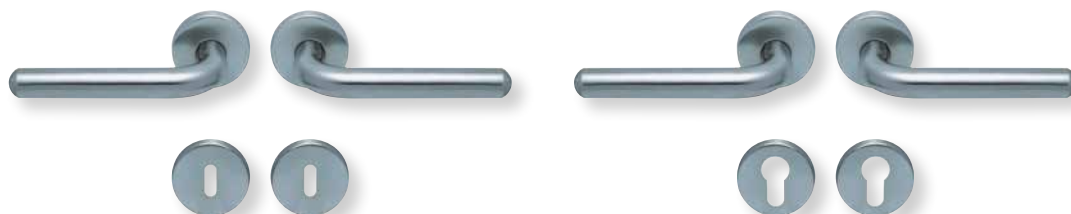

BB - Garnitur EDELSTAHL matt

PZ - Garnitur EDELSTAHL matt



WC - Garnitur EDELSTAHL matt
 WC - Garnitur rot/weiß Anzeige EDELSTAHL matt
 WC - Garnitur rot/grün Anzeige EDELSTAHL matt



PZ - Wechselgarnitur Knopf gerade EDELSTAHL matt



RZ - Garnitur EDELSTAHL matt



PZ - Wechselgarnitur Knopf gekröpft EDELSTAHL matt

Form 1200 auf Rundrosette

	Edelstahl matt		Edelstahl poliert	
		€ exkl. MwSt.		€ exkl. MwSt.
Rosettengarnitur				
BB - Garnitur	PB3.0-12000	41,90	PB3.0-P12000	51,90
PZ - Garnitur	PB3.0-12002	41,90	PB3.0-P12002	51,90
OS - Garnitur (ohne Schlüsselrosette)	PB3.0-12000S	37,90	PB3.0-P12000S	47,90
RZ - Garnitur	PB3.0-12008	41,90	PB3.0-P12008	51,90
WC - Garnitur	PB3.0-12003	51,90	PB3.0-P12003	61,90
WC - Garnitur rot/weiß Anz.	PB3.0-120031	55,90	PB3.0-P120031	65,90
WC - Garnitur rot/grün Anz.	PB3.0-120032	55,90	PB3.0-P120032	65,90
PZ-WG - Knopf ger. DIN R/L	PB3.0-12005/6	55,90	PB3.0-P12005/6	65,90
PZ-WG - Knopf gekr. DIN R/L	PB3.0-120051/61	59,90	PB3.0-P120051/61	69,90
Drückerpaar				
ohne Rosetten	D12001	19,90	DP12001	27,90

Standard-Türstärken: 38 - 42 mm
 Aufpreis für Türstärken ab 42 mm: € 5,00



Drücker EDELSTAHL matt
Rosette EDELSTAHL matt



Drücker EDELSTAHL poliert
Rosette EDELSTAHL poliert

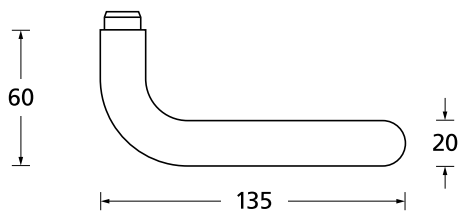



Pullbloc® 3.0 Kugellagertechnik



BB - Garnitur EDELSTAHL poliert



PZ - Garnitur EDELSTAHL poliert



WC - Garnitur EDELSTAHL poliert
WC - Garnitur rot/weiß Anzeige EDELSTAHL poliert
WC - Garnitur rot/grün Anzeige EDELSTAHL poliert



PZ - Wechselgarnitur Knopf gerade
EDELSTAHL poliert



RZ - Garnitur EDELSTAHL poliert



PZ - Wechselgarnitur Knopf gekröpft
EDELSTAHL poliert

Form 1200 auf Quadratrosette

Rosettengarnitur	Edelstahl matt		Edelstahl poliert	
		€ exkl. MwSt.		€ exkl. MwSt.
BB - Garnitur	PB3.0-Q12000	47,90	PB3.0-QP12000	57,90
PZ - Garnitur	PB3.0-Q12002	47,90	PB3.0-QP12002	57,90
OS - Garnitur (ohne Schlüsselrosette)	PB3.0-Q12000S	43,90	PB3.0-QP12000S	53,90
RZ - Garnitur	PB3.0-Q12008	47,90	PB3.0-QP12008	57,90
WC - Garnitur	PB3.0-Q12003	57,90	PB3.0-QP12003	67,90
WC - Garnitur rot/weiß Anz.	PB3.0-Q120031	61,90	PB3.0-QP120031	71,90
WC - Garnitur rot/grün Anz.	PB3.0-Q120032	61,90	PB3.0-QP120032	71,90
PZ-WG - Knopf ger. DIN R/L	PB3.0-Q12005/6	61,90	PB3.0-QP12005/6	71,90
PZ-WG - Knopf gekr. DIN R/L	PB3.0-Q120051/61	65,90	PB3.0-QP120051/61	75,90
Drückerpaar				
ohne Rosetten	D12001	19,90	DP12001	27,90

Standard-Türstärken: 38 - 42 mm
Aufpreis für Türstärken ab 42 mm: € 5,00



Drücker EDELSTAHL matt
Rosette EDELSTAHL matt

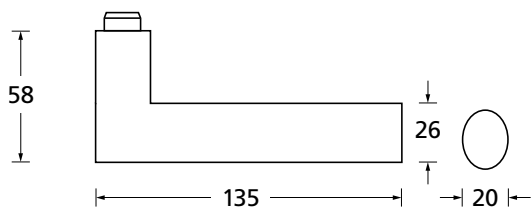



Pullbloc® 3.0 Kugellagertechnik



BB - Garnitur EDELSTAHL matt



PZ - Garnitur EDELSTAHL matt



WC - Garnitur EDELSTAHL matt
WC - Garnitur rot/weiß Anzeige EDELSTAHL matt
WC - Garnitur rot/grün Anzeige EDELSTAHL matt



PZ - Wechselgarnitur Knopf gerade
EDELSTAHL matt



RZ - Garnitur EDELSTAHL matt



PZ - Wechselgarnitur Knopf gekröpft
EDELSTAHL matt

Form 1206 auf Rundrosette

Edelstahl matt

Rosettengarnitur

		€ exkl. MwSt.
BB - Garnitur	PB3.0-12060	43,90
PZ - Garnitur	PB3.0-12062	43,90
OS - Garnitur (ohne Schlüsselrosette)	PB3.0-1206OS	39,90
RZ - Garnitur	PB3.0-12068	43,90
WC - Garnitur	PB3.0-12063	53,90
WC - Garnitur rot/weiß Anz.	PB3.0-120631	57,90
WC - Garnitur rot/grün Anz.	PB3.0-120632	57,90
PZ-WG - Knopf ger. DIN R/L	PB3.0-12065/6	57,90
PZ-WG - Knopf gekr. DIN R/L	PB3.0-120651/61	61,90

Drückerpaar

ohne Rosetten	D12060	21,90
---------------	--------	-------

Standard-Türstärken: 38 - 42 mm
Aufpreis für Türstärken ab 42 mm: € 5,00

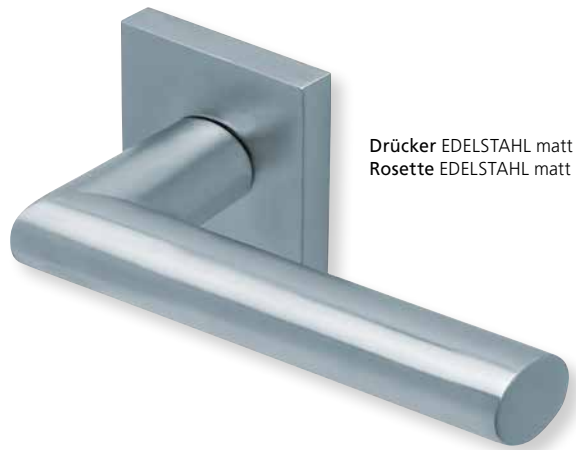

Drücker EDELSTAHL matt
Rosette EDELSTAHL matt

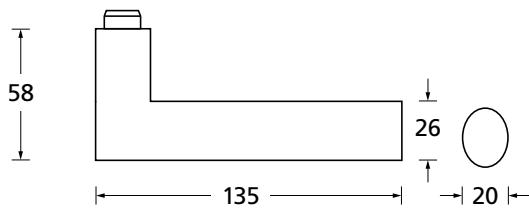



Pullbloc® 3.0 Kugellagertechnik



BB - Garnitur EDELSTAHL matt



PZ - Garnitur EDELSTAHL matt



WC - Garnitur EDELSTAHL matt
WC - Garnitur rot/weiß Anzeige EDELSTAHL matt
WC - Garnitur rot/grün Anzeige EDELSTAHL matt



PZ - Wechselgarnitur Knopf gerade EDELSTAHL matt



RZ - Garnitur EDELSTAHL matt



PZ - Wechselgarnitur Knopf gekröpft EDELSTAHL matt

Form 1206 auf Quadratrosette

Edelstahl matt

Rosettengarnitur

		€ exkl. MwSt.
BB - Garnitur	PB3.0-Q12060	49,90
PZ - Garnitur	PB3.0-Q12062	49,90
OS - Garnitur (ohne Schlüsselrosette)	PB3.0-Q1206OS	45,90
RZ - Garnitur	PB3.0-Q12068	49,90
WC - Garnitur	PB3.0-Q12063	59,90
WC - Garnitur rot/weiß Anz.	PB3.0-Q120631	63,90
WC - Garnitur rot/grün Anz.	PB3.0-Q120632	63,90
PZ-WG - Knopf ger. DIN R/L	PB3.0-Q12065/6	63,90
PZ-WG - Knopf gekr. DIN R/L	PB3.0-Q120651/61	67,90

Drückerpaar

ohne Rosetten	D12060	21,90
---------------	--------	-------

Standard-Türstärken: 38 - 42 mm
Aufpreis für Türstärken ab 42 mm: € 5,00



Drücker EDELSTAHL poliert/EDELSTAHL matt
Rosette EDELSTAHL matt

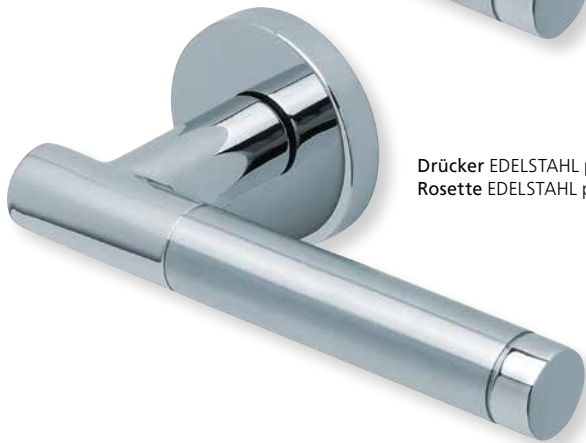

Drücker EDELSTAHL poliert/EDELSTAHL matt
Rosette EDELSTAHL poliert

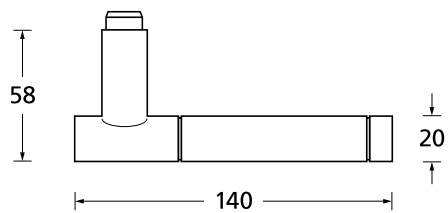



Pullbloc® 3.0 Kugellagertechnik



BB - Garnitur EDELSTAHL poliert



PZ - Garnitur EDELSTAHL poliert



WC - Garnitur EDELSTAHL poliert
WC - Garnitur rot/weiß Anzeige EDELSTAHL poliert
WC - Garnitur rot/grün Anzeige EDELSTAHL poliert



PZ - Wechselgarnitur Knopf gerade EDELSTAHL poliert



RZ - Garnitur EDELSTAHL poliert

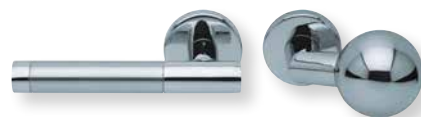

PZ - Wechselgarnitur Knopf gekröpft EDELSTAHL poliert

Form 1275 auf Rundrosette

	Edelstahl matt		Edelstahl poliert	
		€ exkl. MwSt.		€ exkl. MwSt.
Rosettengarnitur				
BB - Garnitur	PB3.0-12750	47,90	PB3.0-P12750	53,90
PZ - Garnitur	PB3.0-12752	47,90	PB3.0-P12752	53,90
OS - Garnitur (ohne Schlüsselrosette)	PB3.0-12750S	43,90	PB3.0-P12750S	49,90
RZ - Garnitur	PB3.0-12758	47,90	PB3.0-P12758	53,90
WC - Garnitur	PB3.0-12753	57,90	PB3.0-P12753	63,90
WC - Garnitur rot/weiß Anz.	PB3.0-127531	61,90	PB3.0-P127531	67,90
WC - Garnitur rot/grün Anz.	PB3.0-127532	61,90	PB3.0-P127532	67,90
PZ-WG - Knopf ger. DIN R/L	PB3.0-12755/6	61,90	PB3.0-P12755/6	67,90
PZ-WG - Knopf gekr. DIN R/L	PB3.0-127551/61	65,90	PB3.0-P127551/61	71,90
Drückerpaar				
ohne Rosetten	D12750	25,90	D12750	25,90

Standard-Türstärken: 38 - 42 mm
Aufpreis für Türstärken ab 42 mm: € 5,00



Drücker EDELSTAHL poliert/EDELSTAHL matt
Rosette EDELSTAHL matt



Drücker EDELSTAHL poliert/EDELSTAHL matt
Rosette EDELSTAHL poliert

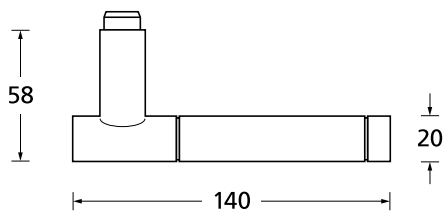



Pullbloc® 3.0 Kugellagertechnik



BB - Garnitur EDELSTAHL poliert



PZ - Garnitur EDELSTAHL poliert



WC - Garnitur EDELSTAHL poliert
WC - Garnitur rot/weiß Anzeige EDELSTAHL poliert
WC - Garnitur rot/grün Anzeige EDELSTAHL poliert



PZ - Wechselgarnitur Knopf gerade EDELSTAHL poliert



RZ - Garnitur EDELSTAHL poliert



PZ - Wechselgarnitur Knopf gekröpft EDELSTAHL poliert

Form 1275 auf Quadratrosette

	Edelstahl matt		Edelstahl poliert	
	€ exkl. MwSt.		€ exkl. MwSt.	
Rosettengarnitur				
BB - Garnitur	PB3.0-Q12750	53,90	PB3.0-QP12750	59,90
PZ - Garnitur	PB3.0-Q12752	53,90	PB3.0-QP12752	59,90
OS - Garnitur (ohne Schlüsselrosette)	PB3.0-Q12750S	49,90	PB3.0-QP12750S	55,90
RZ - Garnitur	PB3.0-Q12758	53,90	PB3.0-QP12758	59,90
WC - Garnitur	PB3.0-Q12753	63,90	PB3.0-QP12753	69,90
WC - Garnitur rot/weiß Anz.	PB3.0-Q127531	67,90	PB3.0-QP127531	73,90
WC - Garnitur rot/grün Anz.	PB3.0-Q127532	67,90	PB3.0-QP127532	73,90
PZ-WG - Knopf ger. DIN R/L	PB3.0-Q12755/6	67,90	PB3.0-QP12755/6	73,90
PZ-WG - Knopf gekr. DIN R/L	PB3.0-Q127551/61	71,90	PB3.0-QP127551/61	77,90
Drückerpaar				
ohne Rosetten	D12750	25,90	D12750	25,90

Standard-Türstärken: 38 - 42 mm
Aufpreis für Türstärken ab 42 mm: € 5,00



Drücker verchromt/nickelmatt
Rosette EDELSTAHL matt



Drücker verchromt/nickelmatt
Rosette EDELSTAHL poliert

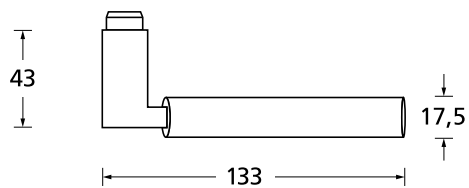



Pullbloc® 3.0 Kugellagertechnik

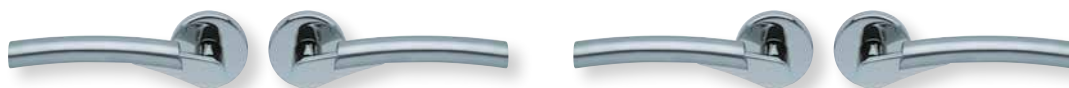

BB - Garnitur EDELSTAHL poliert



PZ - Garnitur EDELSTAHL poliert



WC - Garnitur EDELSTAHL poliert
WC - Garnitur rot/weiß Anzeige EDELSTAHL poliert
WC - Garnitur rot/grün Anzeige EDELSTAHL poliert



PZ - Wechselgarnitur Knopf gerade
EDELSTAHL poliert



RZ - Garnitur EDELSTAHL poliert



PZ - Wechselgarnitur Knopf gekröpft
EDELSTAHL poliert

Form 1764 auf Rundrosette

	Edelstahl matt		Edelstahl poliert	
		€ exkl. MwSt.		€ exkl. MwSt.
Rosettengarnitur				
BB - Garnitur	PB3.0-17640	47,90	PB3.0-P17640	53,90
PZ - Garnitur	PB3.0-17642	47,90	PB3.0-P17642	53,90
OS - Garnitur (ohne Schlüsselrosette)	PB3.0-1764OS	43,90	PB3.0-P1764OS	49,90
RZ - Garnitur	PB3.0-17648	47,90	PB3.0-P17648	53,90
WC - Garnitur	PB3.0-17643	57,90	PB3.0-P17643	63,90
WC - Garnitur rot/weiß Anz.	PB3.0-176431	61,90	PB3.0-P176431	67,90
WC - Garnitur rot/grün Anz.	PB3.0-176432	61,90	PB3.0-P176432	67,90
PZ-WG - Knopf ger. DIN R/L	PB3.0-17645/6	61,90	PB3.0-P17645/6	67,90
PZ-WG - Knopf gekr. DIN R/L	PB3.0-176451/61	65,90	PB3.0-P176451/61	71,90
Drückerpaar				
ohne Rosetten	D17640	25,90	D17640	25,90

Standard-Türstärken: 38 - 42 mm
Aufpreis für Türstärken ab 42 mm: € 5,00



Drücker verchromt/nickelmatt
Rosette EDELSTAHL matt



Drücker verchromt/nickelmatt
Rosette EDELSTAHL poliert

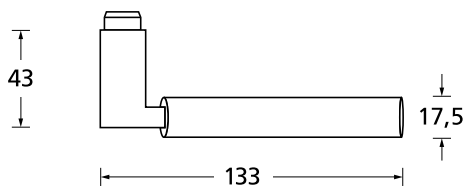



Pullbloc® 3.0 Kugellagertechnik



BB - Garnitur EDELSTAHL poliert



PZ - Garnitur EDELSTAHL poliert



WC - Garnitur EDELSTAHL poliert
WC - Garnitur rot/weiß Anzeige EDELSTAHL poliert
WC - Garnitur rot/grün Anzeige EDELSTAHL poliert



PZ - Wechselgarnitur Knopf gerade
EDELSTAHL poliert



RZ - Garnitur EDELSTAHL poliert



PZ - Wechselgarnitur Knopf gekröpft
EDELSTAHL poliert

Form 1764 auf Quadratrosette

Rosettengarnitur	Edelstahl matt		Edelstahl poliert	
		€ exkl. MwSt.		€ exkl. MwSt.
BB - Garnitur	PB3.0-Q17640	53,90	PB3.0-QP17640	59,90
PZ - Garnitur	PB3.0-Q17642	53,90	PB3.0-QP17642	59,90
OS - Garnitur (ohne Schlüsselrosette)	PB3.0-Q1764OS	49,90	PB3.0-QP1764OS	55,90
RZ - Garnitur	PB3.0-Q17648	53,90	PB3.0-QP17648	59,90
WC - Garnitur	PB3.0-Q17643	63,90	PB3.0-QP17643	69,90
WC - Garnitur rot/weiß Anz.	PB3.0-Q176431	67,90	PB3.0-QP176431	73,90
WC - Garnitur rot/grün Anz.	PB3.0-Q176432	67,90	PB3.0-QP176432	73,90
PZ-WG - Knopf ger. DIN R/L	PB3.0-Q17645/6	67,90	PB3.0-QP17645/6	73,90
PZ-WG - Knopf gekr. DIN R/L	PB3.0-Q176451/61	71,90	PB3.0-QP176451/61	77,90
Drückerpaar				
ohne Rosetten	D17640	25,90	D17640	25,90

Standard-Türstärken: 38 - 42 mm
Aufpreis für Türstärken ab 42 mm: € 5,00

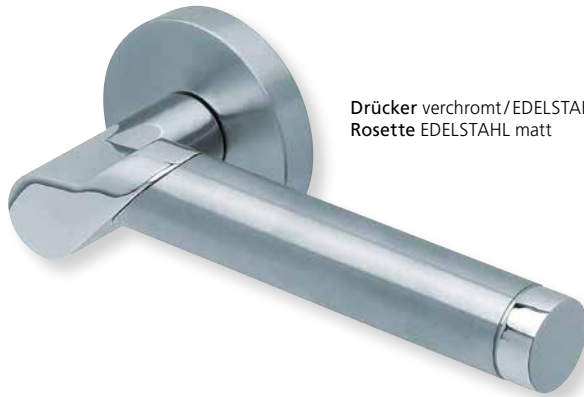

Drücker verchromt/EDELSTAHL matt
Rosette EDELSTAHL matt



Drücker verchromt/EDELSTAHL matt
Rosette EDELSTAHL poliert

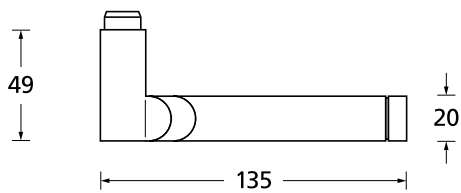



Pullbloc® 3.0 Kugellagertechnik

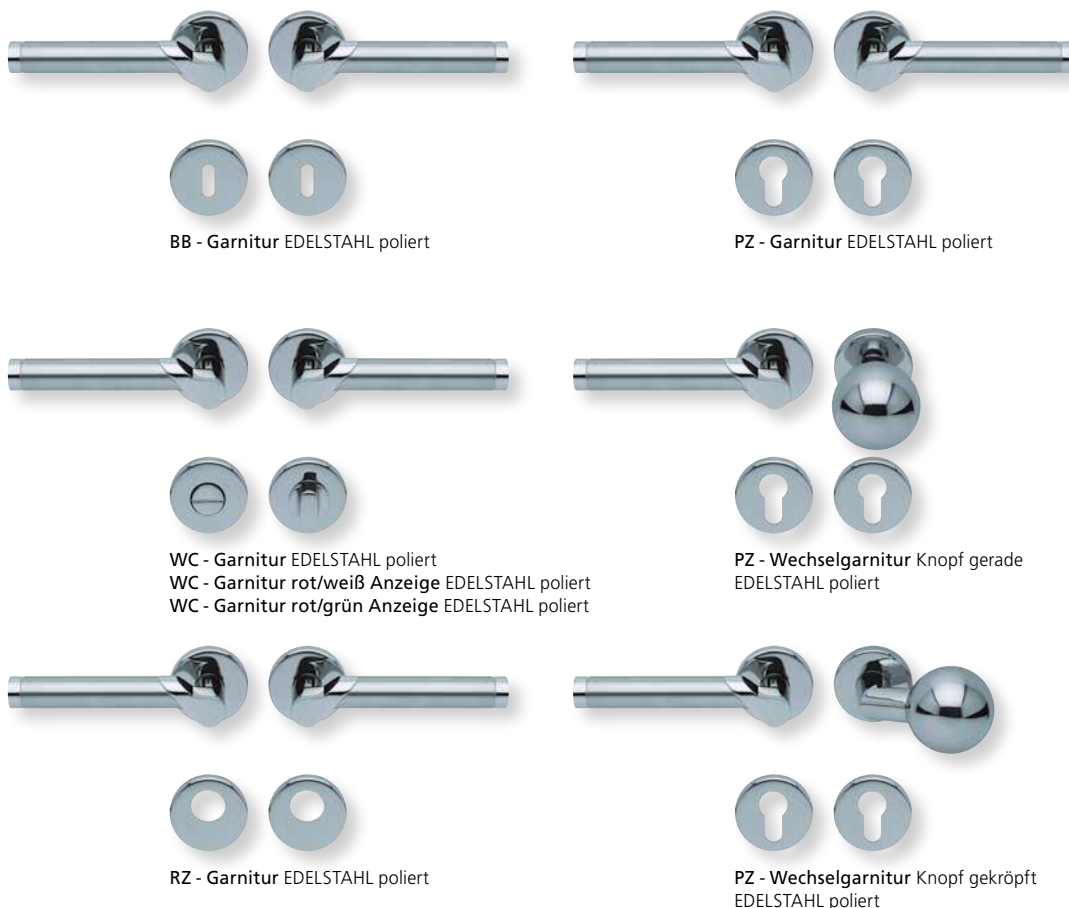

Form 1765 auf Rundrosette

	Edelstahl matt		Edelstahl poliert	
		€ exkl. MwSt.		€ exkl. MwSt.
Rosettengarnitur				
BB - Garnitur	PB3.0-17650	47,90	PB3.0-P17650	53,90
PZ - Garnitur	PB3.0-17652	47,90	PB3.0-P17652	53,90
OS - Garnitur (ohne Schlüsselrosette)	PB3.0-1765OS	43,90	PB3.0-P1765OS	49,90
RZ - Garnitur	PB3.0-17658	47,90	PB3.0-P17658	53,90
WC - Garnitur	PB3.0-17653	57,90	PB3.0-P17653	63,90
WC - Garnitur rot/weiß Anz.	PB3.0-176531	61,90	PB3.0-P176531	67,90
WC - Garnitur rot/grün Anz.	PB3.0-176532	61,90	PB3.0-P176532	67,90
PZ-WG - Knopf ger. DIN R/L	PB3.0-17656/7	61,90	PB3.0-P17656/7	67,90
PZ-WG - Knopf gekr. DIN R/L	PB3.0-176561/71	65,90	PB3.0-P176561/71	71,90
Drückerpaar				
ohne Rosetten	D17650	25,90	D17650	25,90

Standard-Türstärken: 38 - 42 mm
 Aufpreis für Türstärken ab 42 mm: € 5,00

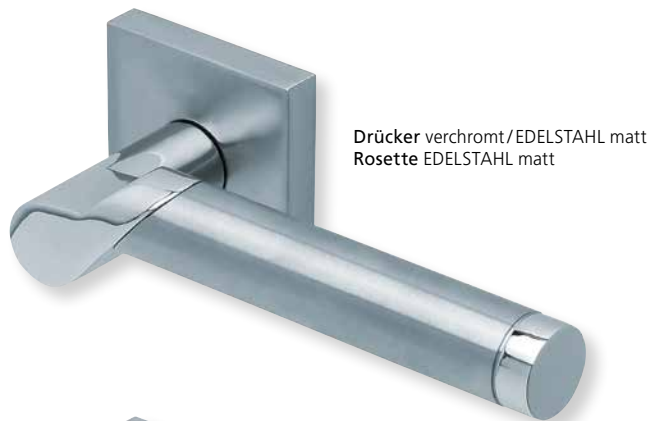

Drücker verchromt/EDELSTAHL matt
Rosette EDELSTAHL matt



Drücker verchromt/EDELSTAHL matt
Rosette EDELSTAHL poliert

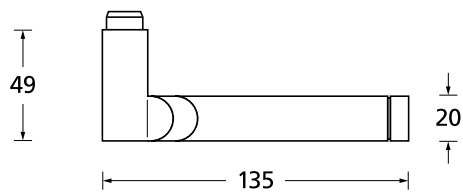



Pullbloc® 3.0 Kugellagertechnik



BB - Garnitur EDELSTAHL poliert



PZ - Garnitur EDELSTAHL poliert



WC - Garnitur EDELSTAHL poliert
WC - Garnitur rot/weiß Anzeige EDELSTAHL poliert
WC - Garnitur rot/grün Anzeige EDELSTAHL poliert



PZ - Wechselgarnitur Knopf gerade EDELSTAHL poliert



RZ - Garnitur EDELSTAHL poliert



PZ - Wechselgarnitur Knopf gekröpft EDELSTAHL poliert

Form 1765 auf Quadratrosette

	Edelstahl matt		Edelstahl poliert	
		€ exkl. MwSt.		€ exkl. MwSt.
Rosettengarnitur				
BB - Garnitur	PB3.0-Q17650	53,90	PB3.0-QP17650	59,90
PZ - Garnitur	PB3.0-Q17652	53,90	PB3.0-QP17652	59,90
OS - Garnitur (ohne Schlüsselrosette)	PB3.0-Q1765OS	49,90	PB3.0-QP1765OS	55,90
RZ - Garnitur	PB3.0-Q17658	53,90	PB3.0-QP17658	59,90
WC - Garnitur	PB3.0-Q17653	63,90	PB3.0-QP17653	69,90
WC - Garnitur rot/weiß Anz.	PB3.0-Q176531	67,90	PB3.0-QP176531	73,90
WC - Garnitur rot/grün Anz.	PB3.0-Q176532	67,90	PB3.0-QP176532	73,90
PZ-WG - Knopf ger. DIN R/L	PB3.0-Q17656/7	67,90	PB3.0-QP17656/7	73,90
PZ-WG - Knopf gekr. DIN R/L	PB3.0-Q176561/71	71,90	PB3.0-QP176561/71	77,90
Drückerpaar				
ohne Rosetten	D17650	25,90	D17650	25,90

Standard-Türstärken: 38 - 42 mm
Aufpreis für Türstärken ab 42 mm: € 5,00



Drücker EDELSTAHL matt - Buche
Rosette EDELSTAHL matt



Drücker EDELSTAHL matt - Eiche
Rosette EDELSTAHL matt



Drücker EDELSTAHL matt - Merbau
Rosette EDELSTAHL matt

In allen heimischen Holzarten lieferbar!

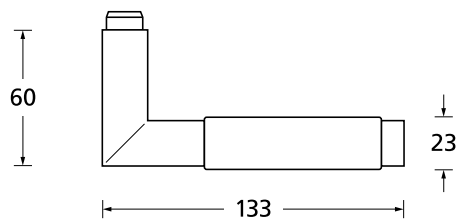



Pullbloc® 3.0 Kugellagertechnik

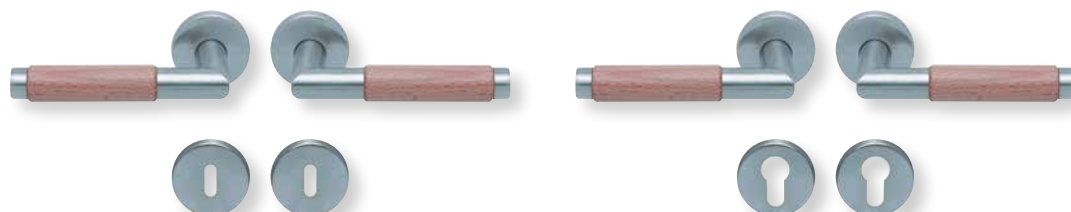

BB - Garnitur EDELSTAHL matt

PZ - Garnitur EDELSTAHL matt

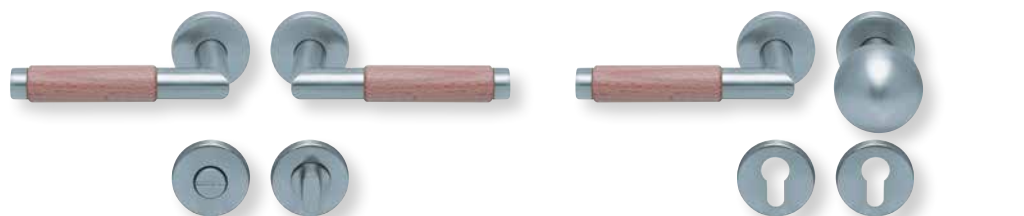

WC - Garnitur EDELSTAHL matt
WC - Garnitur rot/weiß Anzeige EDELSTAHL matt
WC - Garnitur rot/grün Anzeige EDELSTAHL matt

PZ - Wechselgarnitur Knopf gerade EDELSTAHL matt

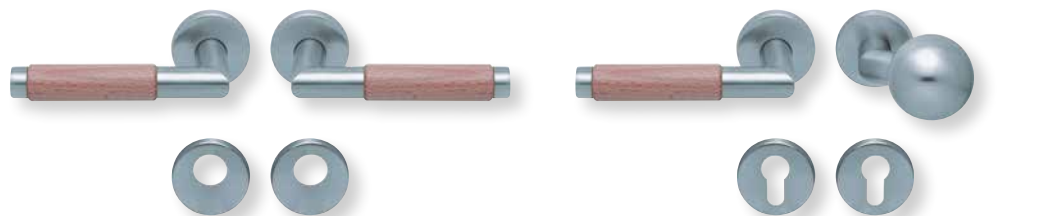

RZ - Garnitur EDELSTAHL matt

PZ - Wechselgarnitur Knopf gekröpft EDELSTAHL matt

Form 1X74 auf Rundrosette

Edelstahl matt

Rosettengarnitur

		€ exkl. MwSt.
BB - Garnitur	PB3.0-1X740	53,90
PZ - Garnitur	PB3.0-1X742	53,90
OS - Garnitur (ohne Schlüsselrosette)	PB3.0-1X740S	49,90
RZ - Garnitur	PB3.0-1X748	53,90
WC - Garnitur	PB3.0-1X743	63,90
WC - Garnitur rot/weiß Anz.	PB3.0-1X7431	67,90
WC - Garnitur rot/grün Anz.	PB3.0-1X7432	67,90
PZ-WG - Knopf ger. DIN R/L	PB3.0-1X746/7	67,90
PZ-WG - Knopf gekr. DIN R/L	PB3.0-1X7461/71	71,90

Drückerpaar

ohne Rosetten	D1X740	29,90
---------------	--------	-------

Standard-Türstärken: 38 - 42 mm
Aufpreis für Türstärken ab 42 mm: € 5,00



Drücker EDELSTAHL matt - Buche
Rosette EDELSTAHL matt

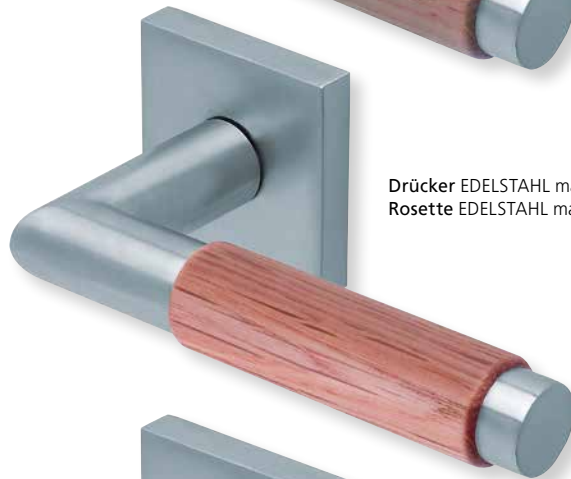

Drücker EDELSTAHL matt - Eiche
Rosette EDELSTAHL matt



Drücker EDELSTAHL matt - Merbau
Rosette EDELSTAHL matt

In allen heimischen Holzarten lieferbar!

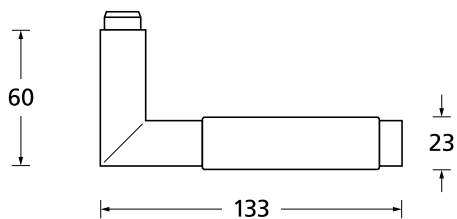



Pullbloc® 3.0 Kugellagertechnik



BB - Garnitur EDELSTAHL matt



PZ - Garnitur EDELSTAHL matt



WC - Garnitur EDELSTAHL matt
WC - Garnitur rot/weiß Anzeige EDELSTAHL matt
WC - Garnitur rot/grün Anzeige EDELSTAHL matt



PZ - Wechselgarnitur Knopf gerade EDELSTAHL matt



RZ - Garnitur EDELSTAHL matt



PZ - Wechselgarnitur Knopf gekröpft EDELSTAHL matt

Form 1X74 auf Quadratrosette

Edelstahl matt

Rosettengarnitur

		€ exkl. MwSt.
BB - Garnitur	PB3.0-Q1X740	59,90
PZ - Garnitur	PB3.0-Q1X742	59,90
OS - Garnitur (ohne Schlüsselrosette)	PB3.0-Q1X740S	55,90
RZ - Garnitur	PB3.0-Q1X748	59,90
WC - Garnitur	PB3.0-Q1X743	69,90
WC - Garnitur rot/weiß Anz.	PB3.0-Q1X7431	73,90
WC - Garnitur rot/grün Anz.	PB3.0-Q1X7432	73,90
PZ-WG - Knopf ger. DIN R/L	PB3.0-Q1X746/7	73,90
PZ-WG - Knopf gekr. DIN R/L	PB3.0-Q1X7461/71	77,90

Drückerpaar

ohne Rosetten	D1X740	29,90
---------------	--------	-------

Standard-Türstärken: 38 - 42 mm
Aufpreis für Türstärken ab 42 mm: € 5,00



Von Seite 198 bis Seite 209 finden Sie Türdrückergarnituren
zertifiziert nach **DIN 18273** für Feuerschutztüren und Rauchschutztüren.

Einleitung	ab	2
Kombinationsmöglichkeiten	ab	18
Schnellübersicht Formen	ab	20
Privat- und Objektbau GK3	ab	27

Feuerschutzgarnituren

Rosetten/Knöpfe/Schilder	ab	211
Office Glastürbeschläge	ab	247
Glastürbeschläge	ab	253
Fenstergriffe	ab	277
Sicherheit	ab	311
Stoßgriffe	ab	331
Muschelgriffe	ab	342
Türstopper	ab	347
Türfixierer	ab	349
Hausnummern	ab	350
Buchstaben und Hinweisschilder	ab	351

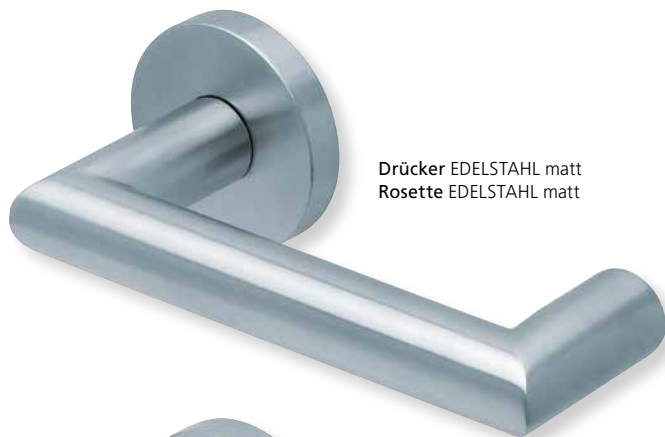

Drücker EDELSTAHL matt
Rosette EDELSTAHL matt



Drücker EDELSTAHL poliert
Rosette EDELSTAHL poliert

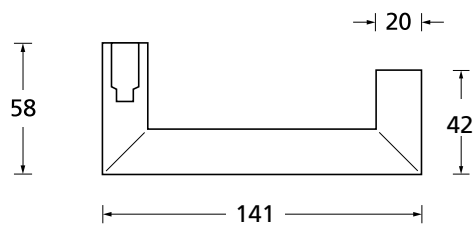



Pullbloc® 3.0 FS Kugellagertechnik DIN 18273 Feuerschutz



PZ - Garnitur EDELSTAHL matt



RZ - Garnitur EDELSTAHL matt



PZ - Wechselgarnitur Knopf gerade
EDELSTAHL matt



PZ - Wechselgarnitur Knopf gekröpft
EDELSTAHL matt

Form 1009 auf Rundrosette

Feuerschutz DIN 18273	Edelstahl matt		Edelstahl poliert	
		€ exkl. MwSt.		€ exkl. MwSt.
PZ - Garnitur	PB3.0FS-10092	57,90	PB3.0FS-P10092	67,90
Blind - Garnitur	PB3.0FS-10091	57,90	PB3.0FS-P10091	67,90
OS - Garnitur (ohne Schlüsselrosette)	PB3.0FS-10090S	53,90	PB3.0FS-P10090S	63,90
RZ - Garnitur	PB3.0FS-10098	57,90	PB3.0FS-P10098	67,90
PZ-WG - Knopf ger. DIN R/L	PB3.0FS-10095/6	71,90	PB3.0FS-P10095/6	81,90
PZ-WG - Knopf gekr. DIN R/L	PB3.0FS-100951/61	75,90	PB3.0FS-P100951/61	85,90
Halbgarnitur für Treibriegel	PB3.0FS-80090S	31,90	PB3.0FS-P80090S	37,90

Standard-Türstärken: 36 - 45 mm
Aufpreis für Türstärken ab 45 mm: € 5,90

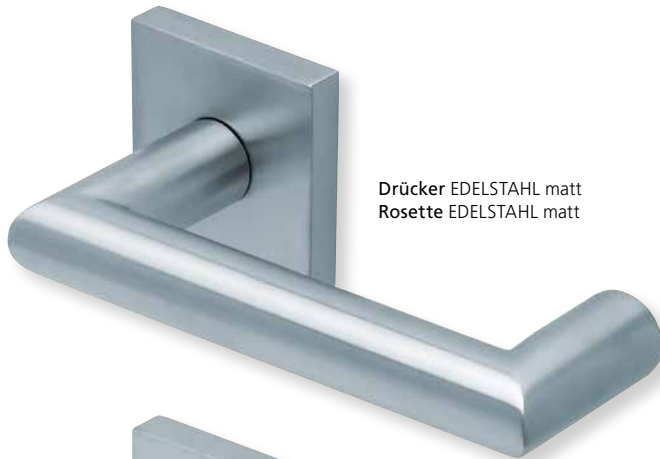

Drücker EDELSTAHL matt
Rosette EDELSTAHL matt



Drücker EDELSTAHL poliert
Rosette EDELSTAHL poliert

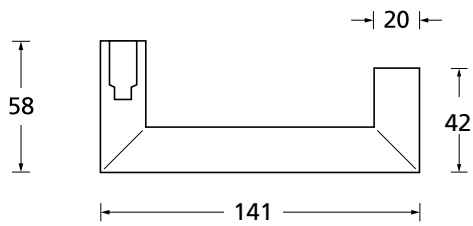



Pullbloc® 3.0 FS Kugellagertechnik DIN 18273 Feuerschutz

201



PZ - Garnitur EDELSTAHL poliert



RZ - Garnitur EDELSTAHL poliert



PZ - Wechselgarnitur Knopf gerade
EDELSTAHL poliert



PZ - Wechselgarnitur Knopf gekröpft
EDELSTAHL poliert

Form 1009 auf Quadratrosette

Feuerschutz DIN 18273	Edelstahl matt		Edelstahl poliert	
		€ exkl. MwSt.		€ exkl. MwSt.
PZ - Garnitur	PB3.0FS-Q10092	63,90	PB3.0FS-QP10092	73,90
Blind - Garnitur	PB3.0FS-Q10091	63,90	PB3.0FS-QP10091	73,90
OS - Garnitur (ohne Schlüsselrosette)	PB3.0FS-Q1009OS	59,90	PB3.0FS-QP1009OS	69,90
RZ - Garnitur	PB3.0FS-Q10098	63,90	PB3.0FS-QP10098	73,90
PZ-WG - Knopf ger. DIN R/L	PB3.0FS-Q10095/6	68,90	PB3.0FS-QP10095/6	78,90
PZ-WG - Knopf gekr. DIN R/L	PB3.0FS-Q100951/61	71,90	PB3.0FS-QP100951/61	81,90
Halbgarnitur für Treibriegel	PB3.0FS-Q8009OS	35,90	PB3.0FS-QP8009OS	41,90

Standard-Türstärken: 36 - 45 mm
Aufpreis für Türstärken ab 45 mm: € 5,90



Drücker EDELSTAHL matt
Rosette EDELSTAHL matt



Drücker EDELSTAHL poliert
Rosette EDELSTAHL poliert

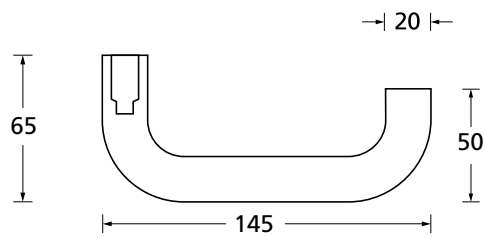



Pullbloc® 3.0 FS Kugellagertechnik DIN 18273 Feuerschutz



PZ - Garnitur EDELSTAHL matt



RZ - Garnitur EDELSTAHL matt



PZ - Wechselgarnitur Knopf gerade
EDELSTAHL matt



PZ - Wechselgarnitur Knopf gekröpft
EDELSTAHL matt

Form 1104 auf Rundrosette

Feuerschutz DIN 18273	Edelstahl matt		Edelstahl poliert	
		€ exkl. MwSt.		€ exkl. MwSt.
PZ - Garnitur	PB3.0FS-11042	51,90	PB3.0FS-P11042	61,90
Blind - Garnitur	PB3.0FS-11041	51,90	PB3.0FS-P11041	61,90
OS - Garnitur (ohne Schlüsselrosette)	PB3.0FS-11040S	47,90	PB3.0FS-P11040S	57,90
RZ - Garnitur	PB3.0FS-11048	51,90	PB3.0FS-P11048	61,90
PZ-WG - Knopf ger. DIN R/L	PB3.0FS-11045/6	65,90	PB3.0FS-P11045/6	75,90
PZ-WG - Knopf gekr. DIN R/L	PB3.0FS-110451/61	69,90	PB3.0FS-P110451/61	79,90
Halbgarnitur für Treibriegel	PB3.0FS-81040S	27,90	PB3.0FS-P81040S	33,90

Standard-Türstärken: 36 - 45 mm
Aufpreis für Türstärken ab 45 mm: € 5,90



Drücker EDELSTAHL matt
Rosette EDELSTAHL matt



Drücker EDELSTAHL poliert
Rosette EDELSTAHL poliert

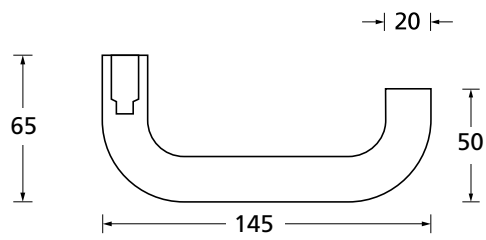



Pullbloc® 3.0 FS Kugellagertechnik DIN 18273 Feuerschutz



PZ - Garnitur EDELSTAHL poliert



RZ - Garnitur EDELSTAHL poliert



PZ - Wechselgarnitur Knopf gerade
EDELSTAHL poliert



PZ - Wechselgarnitur Knopf gekröpft
EDELSTAHL poliert

Form 1104 auf Quadratrosette

Feuerschutz DIN 18273	Edelstahl matt		Edelstahl poliert	
		€ exkl. MwSt.		€ exkl. MwSt.
PZ - Garnitur	PB3.0FS-Q11042	57,90	PB3.0FS-QP11042	67,90
Blind - Garnitur	PB3.0FS-Q11041	57,90	PB3.0FS-QP11041	67,90
OS - Garnitur (ohne Schlüsselrosette)	PB3.0FS-Q11040S	53,90	PB3.0FS-QP11040S	63,90
RZ - Garnitur	PB3.0FS-Q11048	57,90	PB3.0FS-QP11048	67,90
PZ-WG - Knopf ger. DIN R/L	PB3.0FS-Q11045/6	71,90	PB3.0FS-QP11045/6	81,90
PZ-WG - Knopf gekr. DIN R/L	PB3.0FS-Q110451/61	75,90	PB3.0FS-QP110451/61	85,90
Halbgarnitur für Treibriegel	PB3.0FS-Q81040S	31,90	PB3.0FS-QP81040S	37,90

Standard-Türstärken: 36 - 45 mm
Aufpreis für Türstärken ab 45 mm: € 5,90



Drücker EDELSTAHL matt
Rosette EDELSTAHL matt



Drücker EDELSTAHL poliert
Rosette EDELSTAHL poliert

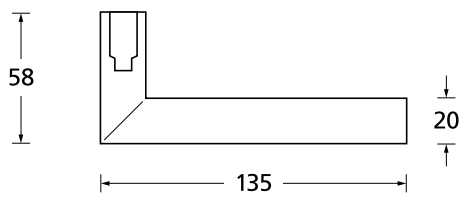



Pullbloc® 3.0 FS Kugellagertechnik DIN 18273 Feuerschutz



PZ - Garnitur EDELSTAHL matt



RZ - Garnitur EDELSTAHL matt



PZ - Wechselgarnitur Knopf gerade
EDELSTAHL matt



PZ - Wechselgarnitur Knopf gekröpft
EDELSTAHL matt

Form 1106 auf Rundrosette

Feuerschutz DIN 18273	Edelstahl matt		Edelstahl poliert	
		€ exkl. MwSt.		€ exkl. MwSt.
PZ - Garnitur	PB3.0FS-11062	51,90	PB3.0FS-P11062	61,90
Blind - Garnitur	PB3.0FS-11061	51,90	PB3.0FS-P11061	61,90
OS - Garnitur (ohne Schlüsselrosette)	PB3.0FS-1106OS	47,90	PB3.0FS-P1106OS	57,90
RZ - Garnitur	PB3.0FS-11068	51,90	PB3.0FS-P11068	61,90
PZ-WG - Knopf ger. DIN R/L	PB3.0FS-11065/6	65,90	PB3.0FS-P11065/6	75,90
PZ-WG - Knopf gekr. DIN R/L	PB3.0FS-110651/61	69,90	PB3.0FS-P110651/61	79,90
Halbgarnitur für Treibriegel	PB3.0FS-8106OS	27,90	PB3.0FS-P8106OS	33,90

Standard-Türstärken: 36 - 45 mm
Aufpreis für Türstärken ab 45 mm: € 5,90

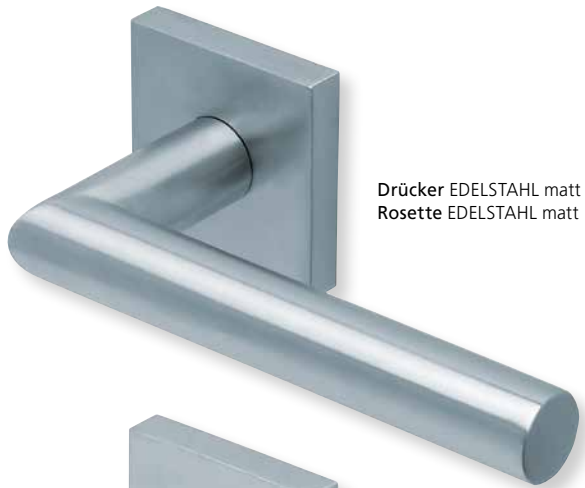

Drücker EDELSTAHL matt
Rosette EDELSTAHL matt



Drücker EDELSTAHL poliert
Rosette EDELSTAHL poliert

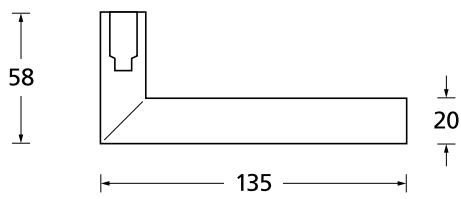



Pullbloc® 3.0 FS Kugellagertechnik DIN 18273 Feuerschutz



PZ - Garnitur EDELSTAHL poliert



RZ - Garnitur EDELSTAHL poliert



PZ - Wechselgarnitur Knopf gerade
EDELSTAHL poliert



PZ - Wechselgarnitur Knopf gekröpft
EDELSTAHL poliert

Form 1106 auf Quadratrosette

Feuerschutz DIN 18273	Edelstahl matt		Edelstahl poliert	
		€ exkl. MwSt.		€ exkl. MwSt.
PZ - Garnitur	PB3.0FS-Q11062	57,90	PB3.0FS-QP11062	67,90
Blind - Garnitur	PB3.0FS-Q11061	57,90	PB3.0FS-QP11061	67,90
OS - Garnitur (ohne Schlüsselrosette)	PB3.0FS-Q11060S	53,90	PB3.0FS-QP11060S	63,90
RZ - Garnitur	PB3.0FS-Q11068	57,90	PB3.0FS-QP11068	67,90
PZ-WG - Knopf ger. DIN R/L	PB3.0FS-Q11065/6	71,90	PB3.0FS-QP11065/6	81,90
PZ-WG - Knopf gekr. DIN R/L	PB3.0FS-Q110651/61	75,90	PB3.0FS-QP110651/61	85,90
Halbgarnitur für Treibriegel	PB3.0FS-Q81060S	31,90	PB3.0FS-QP81060S	37,90

Standard-Türstärken: 36 - 45 mm
Aufpreis für Türstärken ab 45 mm: € 5,90

Einleitung	ab	2
Kombinationsmöglichkeiten	ab	18
Schnellübersicht Formen	ab	20
Privat- und Objektbau GK3	ab	27
Feuerschutzgarnituren	ab	197

Rosetten / Knöpfe / Schilder

Office Glastürbeschläge	ab	247
Glastürbeschläge	ab	253
Fenstergriffe	ab	277
Sicherheit	ab	311
Stoßgriffe	ab	331
Muschelgriffe	ab	342
Türstopper	ab	347
Türfixierer	ab	349
Hausnummern	ab	350
Buchstaben und Hinweisschilder	ab	351

Rundrosetten

Pullbloc® Kugellagertechnik

212



Rosette EDELSTAHL matt



Rosette EDELSTAHL poliert



Rosette PVD Messinggelb

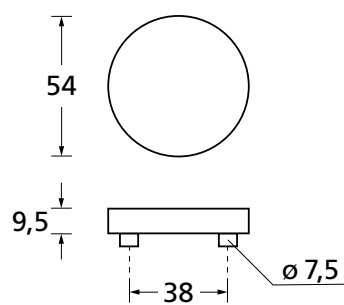



Drückerrosette
EDELSTAHL matt



BB - Rosette
EDELSTAHL matt



PZ - Rosette
EDELSTAHL matt



RZ - Rosette
EDELSTAHL matt



Blind - Rosette
EDELSTAHL matt



WC - Rosette
EDELSTAHL matt



WC - Rosette rot/weiß Anzeige EDELSTAHL matt
WC - Rosette rot/grün Anzeige EDELSTAHL matt

	Edelstahl matt		Edelstahl poliert		PVD Messinggelb	
	€ exkl. MwSt.		€ exkl. MwSt.		€ exkl. MwSt.	
Drückerrosette						
Rosettenpaar	PB3.0-37002	19,80	PB3.0-P37002	23,80	PB3.0-PVM37002	27,80
Drückerrosette Stk.						
DIN R	PB3.0-37001	9,90	PB3.0-P37001	11,90	PB3.0-PVM37001	13,90
DIN L	PB3.0-37000	9,90	PB3.0-P37000	11,90	PB3.0-PVM37000	13,90
Schlüsselrosette						
BB - Rosettenpaar	PB3.0-37006	11,40	PB3.0-P37006	15,40	PB3.0-PVM37006	19,40
PZ - Rosettenpaar	PB3.0-37007	11,40	PB3.0-P37007	15,40	PB3.0-PVM37007	19,40
RZ - Rosettenpaar	PB3.0-37008	11,40	PB3.0-P37008	15,40	PB3.0-PVM37008	19,40
Blind - Rosettenpaar	PB3.0-37012	11,40	PB3.0-P37012	15,40	PB3.0-PVM37012	19,40
WC - Rosetten inkl. Riegel						
ohne Anzeige	PB3.0-27015	27,30	PB3.0-P27015	31,30	PB3.0-PVM27015	35,30
rot/weiß Anzeige	PB3.0-27016	31,30	PB3.0-P27016	35,30	PB3.0-PVM27016	39,30
rot/grün Anzeige	PB3.0-27017	31,30	PB3.0-P27017	35,30	PB3.0-PVM27017	39,30

Quadratrossetten

Pullbloc® Kugellagertechnik

214



Rosette EDELSTAHL matt



Rosette EDELSTAHL poliert



Rosette PVD Messinggelb

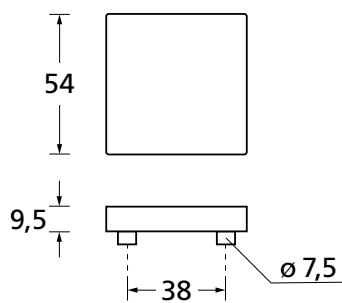



Drückerrosette
EDELSTAHL matt



BB - Rosette
EDELSTAHL matt



PZ - Rosette
EDELSTAHL matt



RZ - Rosette
EDELSTAHL matt



Blind - Rosette
EDELSTAHL matt



WC - Rosette
EDELSTAHL matt



WC - Rosette rot/weiß Anzeige EDELSTAHL matt
WC - Rosette rot/grün Anzeige EDELSTAHL matt

	Edelstahl matt		Edelstahl poliert		PVD Messinggelb	
		€ exkl. MwSt.		€ exkl. MwSt.		€ exkl. MwSt.
Drückerrosette						
Rosettenpaar	PB3.0-Q37002	27,80	PB3.0-QP37002	31,80	PB3.0-QPVM37002	35,80
Drückerrosette Stk.						
DIN R	PB3.0-Q37001	13,90	PB3.0-QP37001	15,90	PB3.0-QPVM37001	17,90
DIN L	PB3.0-Q37000	13,90	PB3.0-QP37000	15,90	PB3.0-QPVM37000	17,90
Schlüsselrosette						
BB - Rosettenpaar	PB3.0-Q37006	19,40	PB3.0-QP37006	23,40	PB3.0-QPVM37006	27,40
PZ - Rosettenpaar	PB3.0-Q37007	19,40	PB3.0-QP37007	23,40	PB3.0-QPVM37007	27,40
RZ - Rosettenpaar	PB3.0-Q37008	19,40	PB3.0-QP37008	23,40	PB3.0-QPVM37008	27,40
Blind - Rosettenpaar	PB3.0-Q37012	19,40	PB3.0-QP37012	23,40	PB3.0-QPVM37012	27,40
WC - Rosetten inkl. Riegel						
ohne Anzeige	PB3.0-Q27015	31,30	PB3.0-QP27015	35,30	PB3.0-QPVM27015	39,30
rot/weiß Anzeige	PB3.0-Q27016	35,30	PB3.0-QP27016	39,30	PB3.0-QPVM27016	43,30
rot/grün Anzeige	PB3.0-Q27017	35,30	PB3.0-QP27017	39,30	PB3.0-QPVM27017	43,30

Ovalrosetten

Pullbloc® Kugellagertechnik

216



Rosette EDELSTAHL matt



Rosette EDELSTAHL poliert

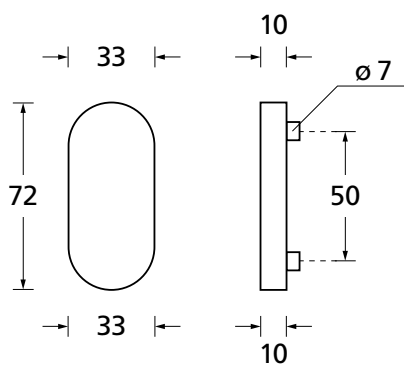



Drückerrosette
EDELSTAHL matt



PZ - Rosette
EDELSTAHL matt



Blind - Rosette
EDELSTAHL matt



WC - Rosette
EDELSTAHL matt

	Edelstahl matt		Edelstahl poliert	
	€ exkl. MwSt.		€ exkl. MwSt.	
Drückerrosette				
durchgeschraubt Paar	PB57100	31,80	PBP57100	35,80
einseitig befestigt Stk.	PB57000	15,90	PBP57000	17,90
Schlüsselrosette PZ				
durchgeschraubt Paar	PB57107	23,40	PBP57107	27,40
einseitig befestigt Stk.	PB57007	11,70	PBP57007	13,70
Schlüsselrosette Blind				
durchgeschraubt Paar	PB57112	23,40	PBP57112	27,40
einseitig befestigt Stk.	PB57012	11,70	PBP57012	13,70
WC - Rosetten inkl. Riegel				
durchgeschraubt Paar	PB57115	39,90	PBP57115	43,90
einseitig befestigt Paar	PB57015	39,90	PBP57015	43,90

Rosetten eckig

Pullbloc® Kugellagertechnik

218



Rosette EDELSTAHL matt



Rosette EDELSTAHL poliert

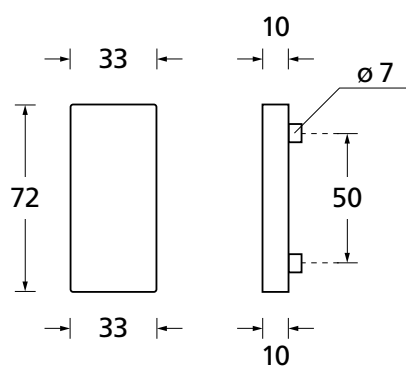



Drückerrosette
EDELSTAHL matt



PZ - Rosette
EDELSTAHL matt



Blind - Rosette
EDELSTAHL matt



WC - Rosette
EDELSTAHL matt

	Edelstahl matt		Edelstahl poliert	
	€ exkl. MwSt.		€ exkl. MwSt.	
Drückerrosette				
durchgeschraubt Paar	PBE57100	39,80	PBEP57100	43,80
einseitig befestigt Stk.	PBE57000	19,90	PBEP57000	21,90
Schlüsselrosette PZ				
durchgeschraubt Paar	PBE57107	31,40	PBEP57107	35,40
einseitig befestigt Stk.	PBE57007	15,70	PBEP57007	17,70
Schlüsselrosette Blind				
durchgeschraubt Paar	PBE57112	31,40	PBEP57112	35,40
einseitig befestigt Stk.	PBE57012	15,70	PBEP57012	17,70
WC - Rosetten inkl. Riegel				
durchgeschraubt Paar	PBE57115	43,90	PBEP57115	47,90
einseitig befestigt Paar	PBE57015	43,90	PBEP57015	47,90

Die Schnellmontage

Flächenbündige Optik und Quadratrosetten flach

220

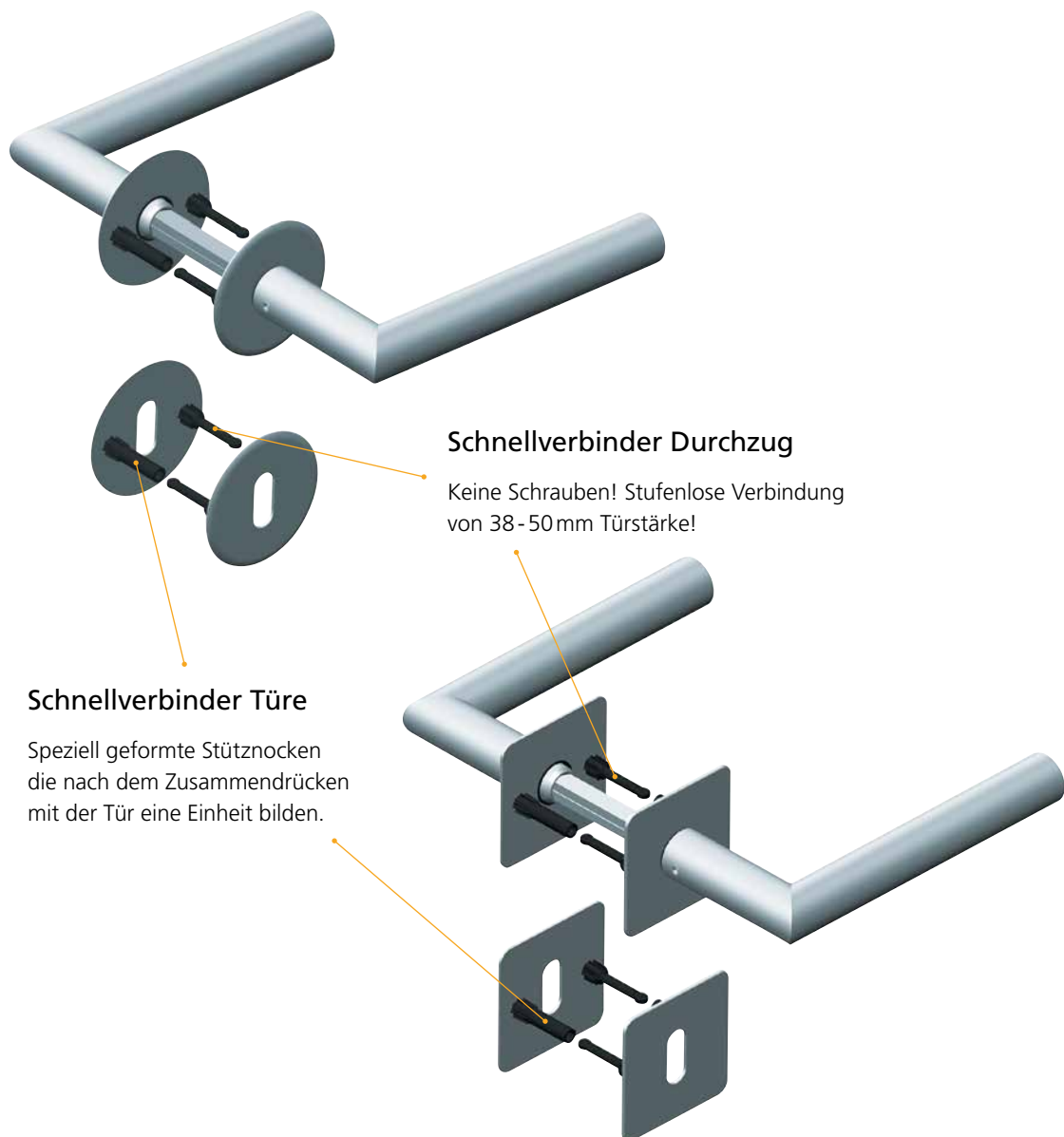



Flächenbündige Optik ohne fräsen, ohne schrauben!



Ausführung: WC



Ausführung: PZ

Flächenbündige Optik Rundrosetten

222



Rosette EDELSTAHL matt



Rosette EDELSTAHL poliert



Rosette PVD Messinggelb

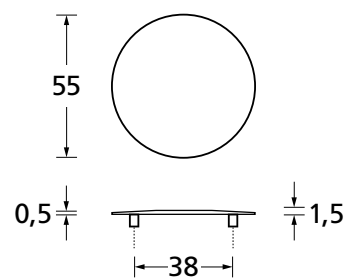

Rundrosetten mit flächenbündiger Optik sind mit allen Türdrückerformen kombinierbar. Rosettengarnituren preisgleich wie **Pullbloc® 3.0**.



Drückerrosette
EDELSTAHL matt



BB - Rosette
EDELSTAHL matt



PZ - Rosette
EDELSTAHL matt



RZ - Rosette
EDELSTAHL matt



Blind - Rosette
EDELSTAHL matt



WC - Rosette
EDELSTAHL matt

	Edelstahl matt	Edelstahl poliert	PVD Messinggelb
Drückerrosette			
Rosettenpaar	F57002 € exkl. MwSt. 25,90	FP57002 € exkl. MwSt. 29,90	FPVM57002 € exkl. MwSt. 33,90
Schlüsselrosette			
BB - Rosettenpaar	F57006 25,90	FP57006 29,90	FPVM57006 33,90
PZ - Rosettenpaar	F57007 25,90	FP57007 29,90	FPVM57007 33,90
RZ - Rosettenpaar	F57008 25,90	FP57008 29,90	FPVM57008 33,90
Blind - Rosettenpaar	F57012 25,90	FP57012 29,90	FPVM57012 33,90
WC - Rosetten			
inkl. WC-Riegel	F57015 29,30	FP57015 33,30	FPVM57015 37,30

Quadratrossetten flach mit Schnellmontage

224



Rosette EDELSTAHL matt



Rosette EDELSTAHL poliert



Rosette PVD Messinggelb

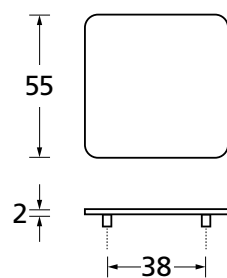

Quadratrossetten flach sind mit allen Türdrückerformen kombinierbar. Rosettengarnituren preisgleich **wie Pullbloc® 3.0**.



Drückerrosette
EDELSTAHL matt



BB - Rosette
EDELSTAHL matt



PZ - Rosette
EDELSTAHL matt



RZ - Rosette
EDELSTAHL matt



Blind - Rosette
EDELSTAHL matt



WC - Rosette
EDELSTAHL matt

	Edelstahl matt	Edelstahl poliert	PVD Messinggelb
	€ exkl. MwSt.	€ exkl. MwSt.	€ exkl. MwSt.
Drückerrosette			
Rosettenpaar	FQ57002 33,90	FQP57002 37,90	FQPVM57002 41,90
Schlüsselrosette			
BB - Rosettenpaar	FQ57006 33,90	FQP57006 37,90	FQPVM57006 41,90
PZ - Rosettenpaar	FQ57007 33,90	FQP57007 37,90	FQPVM57007 41,90
RZ - Rosettenpaar	FQ57008 33,90	FQP57008 37,90	FQPVM57008 41,90
Blind - Rosettenpaar	FQ57012 33,90	FQP57012 37,90	FQPVM57012 41,90
WC - Rosetten			
inkl. WC-Riegel	FQ57015 37,30	FQP57015 41,30	FQPVM57015 45,30

Kugelknopf auf Rundrosette



Kugelknopf gerade
EDELSTAHL matt



Kugelknopf gekröpft
EDELSTAHL matt



Kugelknopf gerade
EDELSTAHL poliert



Kugelknopf gekröpft
EDELSTAHL poliert



Kugelknopf gerade
PVD Messinggelb



Kugelknopf gekröpft
PVD Messinggelb

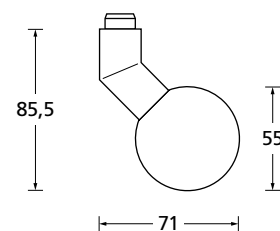
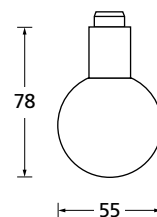

	Edelstahl matt		Edelstahl poliert		PVD Messinggelb	
	€ exkl. MwSt.		€ exkl. MwSt.		€ exkl. MwSt.	
Knopf für Wechselgarnitur						
inkl. PZ-Rosette						
Knopf gerade	77101	31,60	P77101	35,60	PVM77101	39,60
Knopf gekröpft	78101	35,60	P78101	39,60	PVM78101	43,60
Knopf drehbar						
ohne Schlüsselrosette						
Knopf gerade DIN R/L	PB30-16180/1	31,60	PB30-P16180/1	35,60	PB30-PVM16180/1	39,60
Knopf gekröpft DIN R/L	PB30-16182/3	35,60	PB30-P16182/3	39,60	PB30-PVM16182/3	43,60
Knopf einseitig fix						
ohne Schlüsselrosette						
Knopf gerade	69100	31,60	P69100	35,60	PVM69100	39,60
Knopf gekröpft	69101	35,60	P69101	39,60	PVM69101	43,60



Kugelknopf auf Quadratrosette



Kugelknopf gerade
EDELSTAHL matt



Kugelknopf gekröpft
EDELSTAHL matt



Kugelknopf gerade
EDELSTAHL poliert



Kugelknopf gekröpft
EDELSTAHL poliert



Kugelknopf gerade
PVD Messinggelb



Kugelknopf gekröpft
PVD Messinggelb

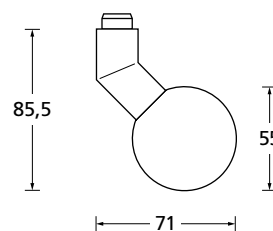
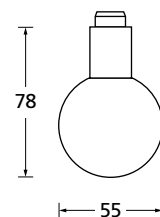

	Edelstahl matt		Edelstahl poliert		PVD Messinggelb	
	€ exkl. MwSt.		€ exkl. MwSt.		€ exkl. MwSt.	
Knopf für Wechselgarnitur						
inkl. PZ-Rosette						
Knopf gerade	Q77101	37,60	QP77101	41,60	QPVM77101	45,60
Knopf gekröpft	Q78101	41,60	QP78101	45,60	QPVM78101	49,60
Knopf drehbar						
ohne Schlüsselrosette						
Knopf gerade DIN R/L	PB3.0-Q16180/1	37,60	PB3.0-QP16180/1	41,60	PB3.0-QPVM16180/1	45,60
Knopf gekröpft DIN R/L	PB3.0-Q16182/3	41,60	PB3.0-QP16182/3	45,60	PB3.0-QPVM16182/3	49,60
Knopf einseitig fix						
ohne Schlüsselrosette						
Knopf gerade	Q69100	37,60	QP69100	41,60	QPVM69100	45,60
Knopf gekröpft	Q69101	41,60	QP69101	45,60	QPVM69101	49,60

Zylindrischer Knopf auf Rundrosette



Zylindrischer Knopf gerade
EDELSTAHL matt



Zylindrischer Knopf versetzt
EDELSTAHL matt



Zylindrischer Knopf gerade
EDELSTAHL poliert



Zylindrischer Knopf versetzt
EDELSTAHL poliert



Zylindrischer Knopf gerade
PVD Messinggelb



Zylindrischer Knopf versetzt
PVD Messinggelb

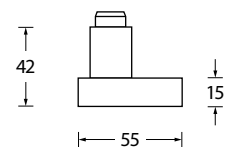
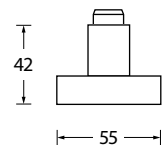

	Edelstahl matt		Edelstahl poliert		PVD Messinggelb	
	€ exkl. MwSt.		€ exkl. MwSt.		€ exkl. MwSt.	
Knopf für Wechselgarnitur						
inkl. PZ-Rosette						
Knopf gerade	72101	31,60	P27101	35,60	PVM72101	39,60
Knopf versetzt	76201	35,60	P76201	39,60	PVM76201	43,60
Knopf drehbar						
ohne Schlüsselrosette						
Knopf gerade DIN R/L	PB3.0-16084/5	31,60	PB3.0-P16084/5	35,60	PB3.0-PVM16084/5	39,60
Knopf versetzt DIN R/L	PB3.0-16086/7	35,60	PB3.0-P16086/7	39,60	PB3.0-PVM16086/7	43,60
Knopf einseitig fix						
ohne Schlüsselrosette						
Knopf gerade	691002	31,60	P691002	35,60	PVM691002	39,60
Knopf versetzt	691012	35,60	P691012	39,60	PVM691012	43,60



Zylindrischer Knopf auf Quadratrosette



Zylindrischer Knopf gerade
EDELSTAHL matt



Zylindrischer Knopf versetzt
EDELSTAHL matt



Zylindrischer Knopf gerade
EDELSTAHL poliert



Zylindrischer Knopf versetzt
EDELSTAHL poliert

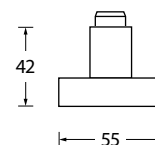

Zylindrischer Knopf gerade
PVD Messinggelb



Zylindrischer Knopf versetzt
PVD Messinggelb

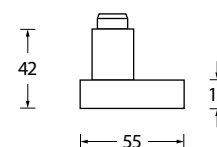

	Edelstahl matt		Edelstahl poliert		PVD Messinggelb	
	€ exkl. MwSt.		€ exkl. MwSt.		€ exkl. MwSt.	
Knopf für Wechselgarnitur						
inkl. PZ-Rosette						
Knopf gerade	Q72101	37,60	QP72101	41,60	QPVM72101	45,60
Knopf versetzt	Q76201	41,60	QP76201	45,60	QPVM76201	49,60
Knopf drehbar						
ohne Schlüsselrosette						
Knopf gerade DIN R/L	PB3.0-Q16084/5	37,60	PB3.0-QP16084/5	41,60	PB3.0-QPVM16084/5	45,60
Knopf versetzt DIN R/L	PB3.0-Q16086/7	41,60	PB3.0-QP16086/7	45,60	PB3.0-QPVM16086/7	49,60
Knopf einseitig fix						
ohne Schlüsselrosette						
Knopf gerade	Q691002	37,60	QP691002	41,60	QPVM691002	45,60
Knopf versetzt	Q691012	41,60	QP691012	45,60	QPVM691012	49,60

Kugelknopf auf Ovalrosette

230



Kugelknopf gekröpft
EDELSTAHL matt



Kugelknopf gekröpft
EDELSTAHL poliert

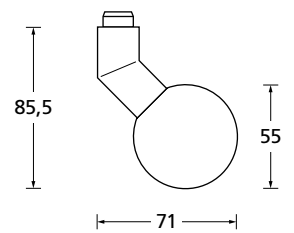

	Edelstahl matt		Edelstahl poliert	
	€ exkl. MwSt.		€ exkl. MwSt.	
Knopf für Wechselgarnitur				
inkl. PZ-Rosette				
Knopf versetzt	65102	35,60	P65101	39,60
Knopf drehbar				
ohne Schlüsselrosette				
Knopf versetzt	PB16192	35,60	PBP16192	39,60



Kugelknopf auf eckiger Rosette



Kugelknopf gekröpft
EDELSTAHL matt



Kugelknopf gekröpft
EDELSTAHL poliert

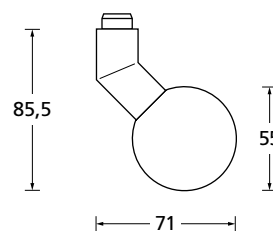

	Edelstahl matt	Edelstahl poliert
Knopf für Wechselgarnitur	_____ € exkl. MwSt.	_____ € exkl. MwSt.
inkl. PZ-Rosette		
Knopf versetzt	E65101 41,60	EP65101 45,60
Knopf drehbar	_____	_____
ohne Schlüsselrosette		
Knopf versetzt	EPB16192 41,60	PBEP16192 45,60

Montageplatte mit Wechselstift für Halbgarnituren



Montageplatte mit Klemmwechselstift 8 mm

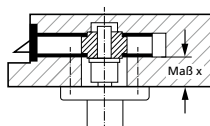

Montageplatte mit Klemmwechselstift 8/10 mm

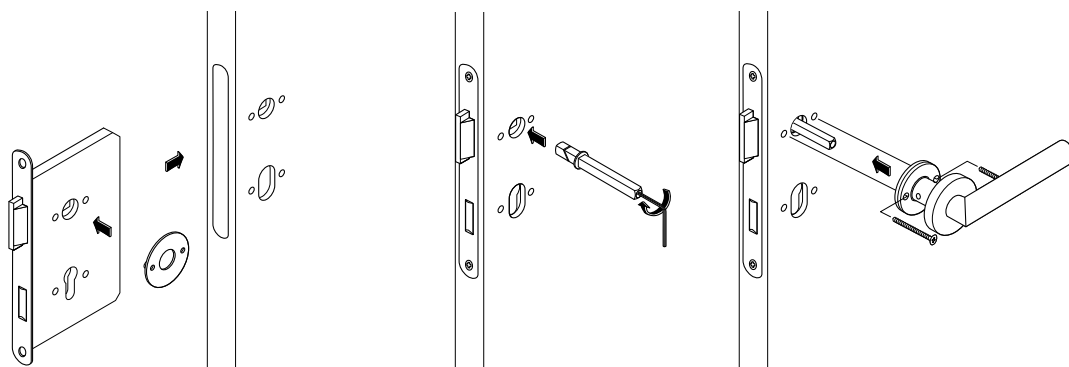
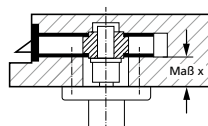

Klemmwechselstift

Set Klemmwechselstift

Länge: 58 mm	x: 9 - 19 mm
Länge: 68 mm	x: 19 - 29 mm
Länge: 78 mm	x: 29 - 39 mm
Länge: 88 mm	x: 39 - 49 mm
Länge: 98 mm	x: 49 - 59 mm
Länge: 108 mm	x: 59 - 69 mm
Länge: 118 mm	x: 69 - 79 mm

8 mm

	€	exkl. MwSt.
00140Set	21,90	
00141Set	21,90	
00190Set	21,90	
00191Set	21,90	
00192Set	21,90	
00193Set	21,90	
00194Set	21,90	

Klemmwechselstift

8/10 mm

	€	exkl. MwSt.
00144Set	25,90	
00145Set	25,90	
00196Set	25,90	
00197Set	25,90	
00198Set	25,90	
00199Set	25,90	



Riegel für Sperrbügel

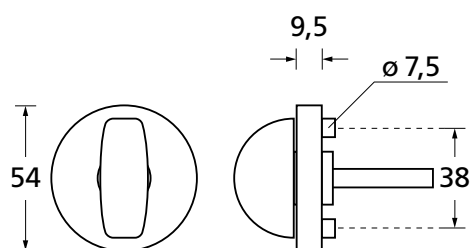

Riegel für Sperrbügel € exkl. MwSt.
Stiftlänge: 35/42 mm SB87015 29,90

Langschilder

Pullbloc® Kugellagertechnik

234



Langschild
EDELSTAHL matt



Langschild
EDELSTAHL poliert

Langschilder sind kombinierbar mit allen Türdrückerformen.



Langschild schmal
EDELSTAHL matt



Langschild schmal
EDELSTAHL poliert

Langschilder

Pullbloc® Kugellagertechnik

236



Langschild
EDELSTAHL matt



Langschild
EDELSTAHL poliert

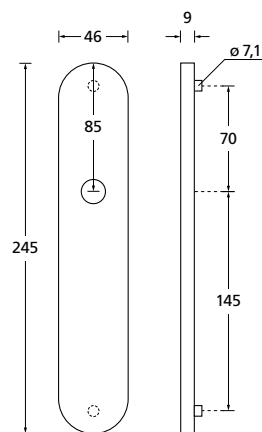
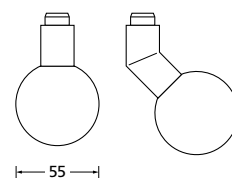

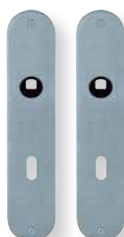

BB - Garnitur EDELSTAHL matt

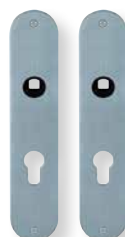

PZ - Garnitur EDELSTAHL matt



WC - Garnitur EDELSTAHL matt



WC - Garnitur rot/weiß Anzeige EDELSTAHL matt
WC - Garnitur rot/grün Anzeige EDELSTAHL matt



PZ - Wechselgarnitur Knopf gerade
EDELSTAHL matt



PZ - Wechselgarnitur Knopf gekröpft
EDELSTAHL matt

	Edelstahl matt		Edelstahl poliert	
		€ exkl. MwSt.		€ exkl. MwSt.
Langschild				
BB - Garnitur	PB27026	63,90	PBP27026	67,90
PZ - Garnitur	PB27027	63,90	PBP27027	67,90
Blind	PB27021	63,90	PBP27021	67,90
WC - Garnitur inkl. Riegel				
ohne Anzeige	PB27025	75,90	PBP27025	79,90
rot/weiß Anz.	PB270251	91,90	PBP270251	95,90
rot/grün Anz.	PB270252	91,90	PBP270252	95,90
Wechselgarnitur				
PZ-WG - Knopf ger.	67201	75,90	P67201	79,90
PZ-WG - Knopf gekr.	67202	79,90	P67202	83,90
Wechselgarnitur				
Knopf drehbar				
PZ-WG - Knopf ger.	PB16184	79,90	PBP16184	83,90
PZ-WG - Knopf gekr.	PB16185	83,90	PBP16185	87,90

Langschilder schmal

Pullbloc® Kugellagertechnik

238



Langschild schmal
EDELSTAHL matt



Langschild schmal
EDELSTAHL poliert

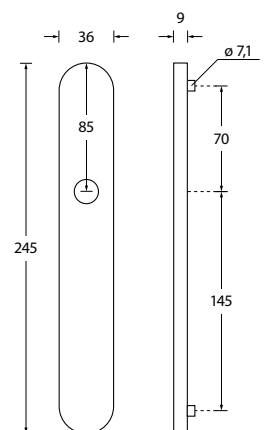
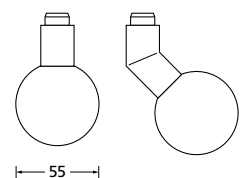



BB - Garnitur EDELSTAHL matt



PZ - Garnitur EDELSTAHL matt



WC - Garnitur EDELSTAHL matt



WC - Garnitur rot/weiß Anzeige EDELSTAHL matt
WC - Garnitur rot/grün Anzeige EDELSTAHL matt



PZ - Wechselgarnitur Knopf gerade
EDELSTAHL matt



PZ - Wechselgarnitur Knopf gekröpft
EDELSTAHL matt

	Edelstahl matt		Edelstahl poliert	
		€ exkl. MwSt.		€ exkl. MwSt.
Langschild				
BB - Garnitur	PB27056	63,90	PBP27056	67,90
PZ - Garnitur	PB27059	63,90	PBP27059	67,90
Blind	PB27051	63,90	PBP27051	67,90
WC - Garnitur inkl. Riegel				
ohne Anzeige	PB27055	75,90	PBP27055	79,90
rot/weiß Anz.	PB270551	91,90	PBP270551	95,90
rot/grün Anz.	PB270552	91,90	PBP270552	95,90
Wechselgarnitur				
PZ-WG - Knopf ger.	61201	75,90	P62201	79,30
PZ-WG - Knopf gekr.	62202	79,90	P62202	83,90
Wechselgarnitur				
Knopf drehbar				
PZ-WG - Knopf ger.	PB16194	79,90	PBP16194	83,90
PZ-WG - Knopf gekr.	PB16195	83,90	PBP16195	87,90

Kurzschilder

Pullbloc® Kugellagertechnik

240



Kurzschild
EDELSTAHL matt



Kurzschild
EDELSTAHL poliert

Kurzschilder sind kombinierbar mit allen Türdrückerformen.



Kurzschild schmal
EDELSTAHL matt



Kurzschild schmal
EDELSTAHL poliert

Kurzschilder

Pullbloc® Kugellagertechnik

242



Kurzschild
EDELSTAHL matt



Kurzschild
EDELSTAHL poliert

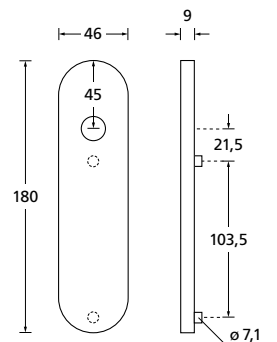
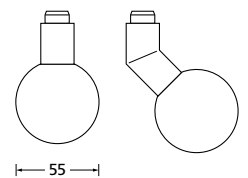



BB - Garnitur EDELSTAHL matt



PZ - Garnitur EDELSTAHL matt



WC - Garnitur EDELSTAHL matt



WC - Garnitur rot/weiß Anzeige EDELSTAHL matt
WC - Garnitur rot/grün Anzeige EDELSTAHL matt



PZ - Wechselgarnitur Knopf gerade
EDELSTAHL matt



PZ - Wechselgarnitur Knopf gekröpft
EDELSTAHL matt

	Edelstahl matt		Edelstahl poliert	
		€ exkl. MwSt.		€ exkl. MwSt.
Langschild				
BB - Garnitur	PB27036	59,90	PBP27036	63,90
PZ - Garnitur	PB27039	59,90	PBP27039	63,90
Blind	PB27031	59,90	PBP27031	63,90
WC - Garnitur inkl. Riegel				
ohne Anzeige	PB27035	71,90	PBP27035	75,90
rot/weiß Anz.	PB270351	87,90	PBP270351	91,90
rot/grün Anz.	PB270352	67,90	PBP270352	91,90
Wechselgarnitur				
PZ-WG - Knopf ger.	67301	71,90	P67301	75,90
PZ-WG - Knopf gekr.	67302	75,90	P67302	79,90
Wechselgarnitur Knopf drehbar				
PZ-WG - Knopf ger.	PB16186	75,90	PBP16186	79,90
PZ-WG - Knopf gekr.	PB16185	79,90	PBP16187	83,90

Standard-Türstärken: 36 - 45 mm

Kurzschilder schmal

Pullbloc® Kugellagertechnik

244



Kurzschild schmal
EDELSTAHL matt



Kurzschild schmal
EDELSTAHL poliert

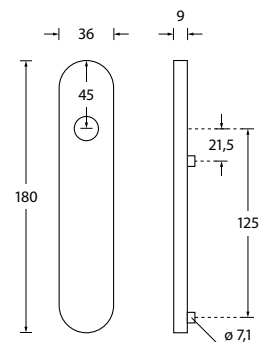
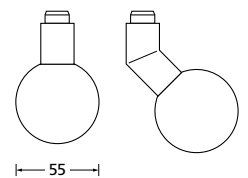



BB - Garnitur EDELSTAHL matt



PZ - Garnitur EDELSTAHL matt



WC - Garnitur EDELSTAHL matt



WC - Garnitur rot/weiß Anzeige EDELSTAHL matt
WC - Garnitur rot/grün Anzeige EDELSTAHL matt



PZ - Wechselgarnitur Knopf gerade
EDELSTAHL matt



PZ - Wechselgarnitur Knopf gekröpft
EDELSTAHL matt

	Edelstahl matt		Edelstahl poliert	
		€ exkl. MwSt.		€ exkl. MwSt.
Kurzschild schmal				
BB - Garnitur	PB27066	59,90	PBP27066	63,90
PZ - Garnitur	PB27069	59,90	PBP27069	63,90
Blind	PB27061	59,90	PBP27061	63,90
WC - Garnitur inkl. Riegel				
ohne Anzeige	PB27065	71,90	PBP27065	75,90
rot/weiß Anz.	PB270651	87,90	PBP270651	91,90
rot/grün Anz.	PB270652	67,90	PBP270652	91,90
Wechselgarnitur				
PZ-WG - Knopf ger.	62301	71,90	P62301	75,90
PZ-WG - Knopf gekr.	61302	75,90	P62302	79,90
Wechselgarnitur				
Knopf drehbar				
PZ-WG - Knopf ger.	PB16196	75,90	PBP16196	79,90
PZ-WG - Knopf gekr.	PB16195	79,90	PBP16197	83,90

Standard-Türstärken: 36 - 45 mm

Von Seite 254 bis Seite 259 finden Sie Office Glastürschlösser zertifiziert nach **DIN EN 12209** laut folgendem Schlüssel.

Gebrauchskategorie	Dauerfunktionstüchtigkeit und Belastung der Falle	Türmasse und Schließkraft	Eignung für Verwendung an Feuer-/Rauchschutztüren	Sicherheit	Korrosionsbeständigkeit und Temperatur	Schutzwirkung und Anbohrwiderstand
3	M	5	0	0	F	0

Türbezogener Verwendungsbe- reich	Art der Schlüsselbe- tätigung und Verriegelung	Art der Spindel- betätigung	Schlüssel- kennung
E	0	0	0

Einleitung	ab	2
Kombinationsmöglichkeiten	ab	18
Schnellübersicht Formen	ab	20
Privat- und Objektbau GK3	ab	27
Feuerschutzgarnituren	ab	197
Rosetten/Knöpfe/Schilder	ab	211

Office Glastürbeschläge

Glastürbeschläge	ab	253
Fenstergriffe	ab	277
Sicherheit	ab	311
Stoßgriffe	ab	331
Muschelgriffe	ab	342
Türstopper	ab	347
Türfixierer	ab	349
Hausnummern	ab	350
Buchstaben und Hinweisschilder	ab	351



Office Glastürschloss **Form A**



Office Gegenkasten Form A
Edelstahl matt



Office Glastürschloss Form A
Edelstahl matt

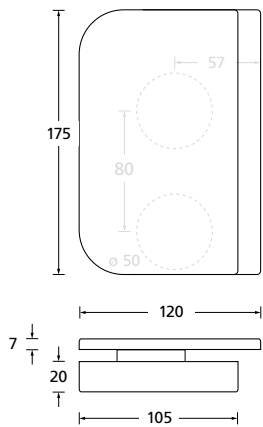

Office Glasürschloss Blind

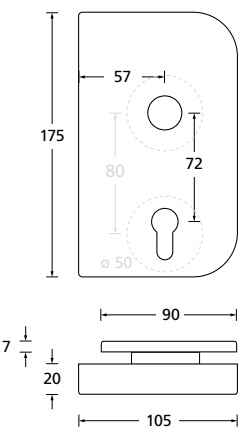

Office Glasürschloss PZ

Edelstahl matt

Glastürset Form A	
DIN R Glastürset Blind	RO201153R
DIN R Glastürset PZ	RO201173R
DIN L Standflügelset	RO20130L
Glastürset Form A	
DIN L Glastürset Blind	RO201153L
DIN L Glastürset PZ	RO201173L
DIN R Standflügelset	RO20130R

	€ exkl. MwSt.
RO201153R	151,90
RO201173R	161,90
RO20130L	207,90
RO201153L	151,90
RO201173L	161,90
RO20130R	207,90

Edelstahl matt

Form A	
DIN R Glasürschloss Blind	O20115R
DIN R Glasürschloss PZ	O20117R
DIN L Gegenkasten	O20131L
Form A	
DIN L Glasürschloss Blind	O20115L
DIN L Glasürschloss PZ	O20117L
DIN R Gegenkasten	O20131R

	€ exkl. MwSt.
O20115R	99,90
O20117R	109,90
O20131L	99,90
O20115L	99,90
O20117L	109,90
O20131R	99,90

Glastürsets inkl. 3-tlg. Glastürbändern, und Rahmenteile für Holzargen (ohne Drückerpaar).
 Standflügelsets inkl. 3-tlg. Glastürbändern, Rahmenteile für Holzargen und Türfeststeller.

Office Glastürschloss **Form B**



Office Gegenkasten **Form B**
Edelstahl matt



Office Glastürschloss **Form B**
Edelstahl matt

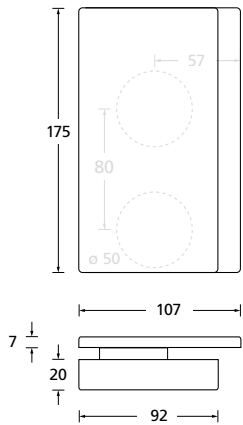

Office Glasürschloss Blind

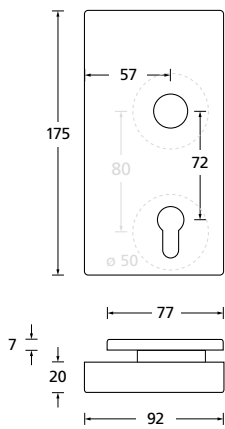

Office Glasürschloss PZ

Edelstahl matt

Glastürset Form B

	€	exkl. MwSt.
DIN R Glastürset Blind	AO201153R	151,90
DIN R Glastürset PZ	AO201173R	161,90
DIN L Standflügelset	AO20130L	207,90

Glastürset Form B

	€	exkl. MwSt.
DIN L Glastürset Blind	AO201153L	151,90
DIN L Glastürset PZ	AO201173L	161,90
DIN R Standflügelset	AO20130R	207,90

Edelstahl matt

Form B

	€	exkl. MwSt.
DIN R Glasürschloss Blind	O20215R	99,90
DIN R Glasürschloss PZ	O20217R	109,90
DIN L Gegenkasten	O20231L	99,90

Form B

	€	exkl. MwSt.
DIN L Glasürschloss Blind	O20215L	99,90
DIN L Glasürschloss PZ	O20217L	109,90
DIN R Gegenkasten	O20231R	99,90

Glastürsets inkl. 3-tlg. Glastürbändern, und Rahmenteile für Holzzargen (ohne Drückerpaar).
Standflügelsets inkl. 3-tlg. Glastürbändern, Rahmenteile für Holzzargen und Türfeststeller.

Von Seite 254 bis Seite 259 finden Sie Glastürschlösser zertifiziert nach **DIN EN 12209** laut folgendem Schlüssel.

Gebrauchskategorie	Dauerfunktionstüchtigkeit und Belastung der Falle	Türmasse und Schließkraft	Eignung für Verwendung an Feuer-/Rauchschutztüren	Sicherheit	Korrosionsbeständigkeit und Temperatur	Schutzwirkung und Anbohrwiderstand
3	M	5	0	0	F	0

Türbezogener Verwendungsbe- reich	Art der Schlüsselbe- tätigung und Verriegelung	Art der Spindel- betätigung	Schlüssel- kennung
E	A/D/0	2	0

Einleitung	ab	2
Kombinationsmöglichkeiten	ab	18
Schnellübersicht Formen	ab	20
Privat- und Objektbau GK3	ab	27
Feuerschutzgarnituren	ab	197
Rosetten/Knöpfe/Schilder	ab	211
Office Glastürbeschläge	ab	247

Glastürbeschläge

Fenstergriffe	ab	277
Sicherheit	ab	311
Stoßgriffe	ab	331
Muschelgriffe	ab	342
Türstopper	ab	347
Türfixierer	ab	349
Hausnummern	ab	350
Buchstaben und Hinweisschilder	ab	351

Glastürschloss **Form A**



EDELSTAHL matt



ALUMINIUM EV1



EDELSTAHL poliert



PVD Messinggelb

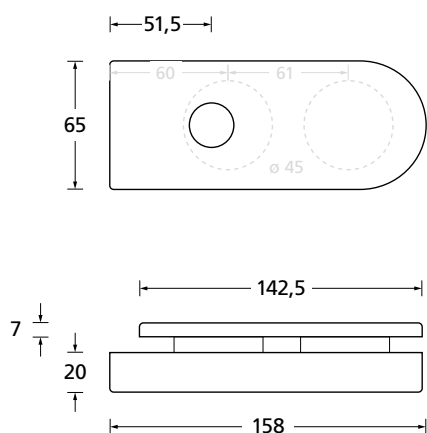

Glastürschloss Blind



Glastürschloss BB



Glastürschloss PZ



Glastürschloss WC Innen



Glastürschloss WC Außen

Form A	Edelstahl matt		Aluminium EV1		Edelstahl poliert		PVD Messinggelb	
		€ exkl. MwSt.		€ exkl. MwSt.		€ exkl. MwSt.		€ exkl. MwSt.
Glastürschloss Blind	20115	79,90	30115	69,90	P20115	119,90	PVM20115	139,90
Glastürschloss BB	20116	89,90			P20116	129,90	PVM20116	149,90
Glastürschloss PZ	20117	89,90	30117	79,90	P20117	129,90	PVM20117	149,90
Glastürschloss WC	20118	109,90	30118	99,90	P20118	149,90	PVM20118	169,90
Glastürset Form A inkl. 3-tlg. Glastürbändern, abgesetzter Falle und Rahmentteile für Holzzargen (ohne Drückerpaar)								
Glastürset Blind	R201153	131,90	R301153	121,90	P201153	231,90	PVM201153	271,90
Glastürset BB	R201163	141,90			P201163	241,90	PVM201163	281,90
Glastürset PZ	R201173	141,90	R301173	131,90	P201173	241,90	PVM201173	281,90
Glastürset WC	R201183	161,90	R301183	151,90	P201183	261,90	PVM201183	301,90

Glastürschloss **Form B**



EDELSTAHL matt



ALUMINIUM EV1



EDELSTAHL poliert



PVD Messinggelb

Glastürschlösser sind **kombinierbar mit allen Drückerpaaren** von Seite 27 - 195 (ALUMINIUM EV1 nur Form 1104 und 1106).

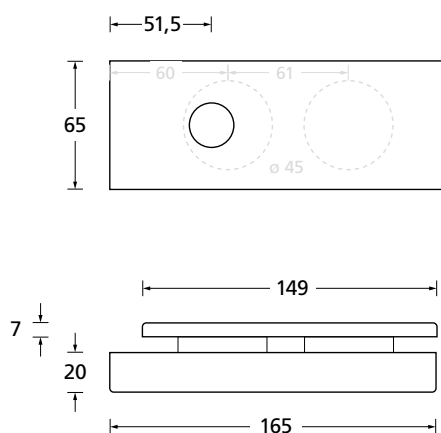

Glastürschloss Blind



Glastürschloss BB



Glastürschloss PZ



Glastürschloss WC Innen



Glastürschloss WC Außen

Form B	Edelstahl matt		Aluminium EV1		Edelstahl poliert		PVD Messinggelb	
	Art-Nr.	€ exkl. MwSt.	Art-Nr.	€ exkl. MwSt.	Art-Nr.	€ exkl. MwSt.	Art-Nr.	€ exkl. MwSt.
Glastürschloss Blind	20215	79,90	30215	69,90	P20215	119,90	PVM20215	139,90
Glastürschloss BB	20216	89,90			P20216	129,90	PVM20216	149,90
Glastürschloss PZ	20217	89,90	30217	79,90	P20217	129,90	PVM20217	149,90
Glastürschloss WC	20218	109,90	30218	99,90	P20218	149,90	PVM20218	169,90
Glastürset Form B inkl. 3-tlg. Glasübändern, abgesetzter Falle und Rahmenteile für Holzzargen (ohne Drückerpaar)								
Glastürset Blind	A202153	131,90	R302153	121,90	P202153	231,90	PVM202153	271,90
Glastürset BB	A202163	141,90			P202163	241,90	PVM202163	281,90
Glastürset PZ	A202173	141,90	R302173	131,90	P202173	241,90	PVM202173	281,90
Glastürset WC	A202183	161,90	R302183	151,90	P202183	261,90	PVM202183	301,90

Glastürschloss **Form C**



EDELSTAHL matt



EDELSTAHL poliert



PVD Messinggelb

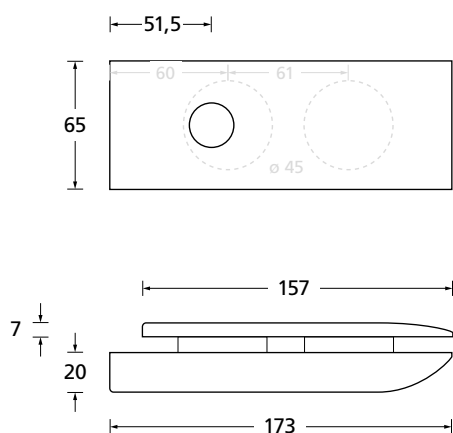

Glastürschloss Blind



Glastürschloss BB



Glastürschloss PZ



Glastürschloss WC Innen



Glastürschloss WC Außen

Form C	Edelstahl matt		Edelstahl poliert		PVD Messinggelb	
	€ exkl. MwSt.		€ exkl. MwSt.		€ exkl. MwSt.	
Glastürschloss Blind	20215	79,90	P20215	119,90	PVM20215	139,90
Glastürschloss BB	20216	89,90	P20216	129,90	PVM20216	149,90
Glastürschloss PZ	20217	89,90	P20217	129,90	PVM20217	149,90
Glastürschloss WC	20218	109,90	P20218	149,90	PVM20218	169,90
Glastürset Form C inkl. 3-tlg. Glastürbändern, abgesetzter Falle und Rahmenteile für Holzzargen (ohne Drückerpaar)						
Glastürset Blind	A202153	131,90	P202153	231,90	PVM202153	271,90
Glastürset BB	A202163	141,90	P202163	241,90	PVM202163	281,90
Glastürset PZ	A202173	141,90	P202173	241,90	PVM202173	281,90
Glastürset WC	A202183	161,90	P202183	261,90	PVM202183	301,90

Gegenkasten **Form A**



EDELSTAHL matt



ALUMINIUM EV1



EDELSTAHL poliert



PVD Messinggelb

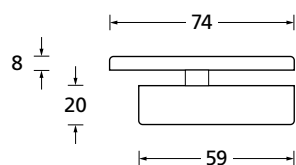
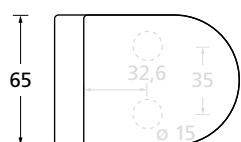
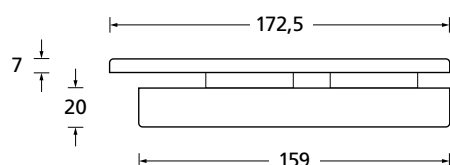
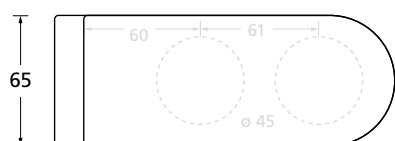

Gegenkasten lang



Gegenkasten kurz

	Edelstahl matt	Aluminium EV1	Edelstahl poliert	PVD Messinggelb
	€ exkl. MwSt.	€ exkl. MwSt.	€ exkl. MwSt.	€ exkl. MwSt.
Gegenkasten Form A				
lang	20131L 79,90	30131L 69,90	P20131L 119,90	PVM20131L 139,90
kurz	20131 71,90	30131 61,90	P20131 111,90	PVM20131 131,90
Standflügelset Form A inkl 3-tlg. Glasübändern, Rahmenteile für Holzzargen und Türfeststeller				
Standflügelset lang	R20130L 187,90	R30130L 171,90	P20130L 307,90	PVM20130L 377,90
Standflügelset kurz	R20130 179,90	R30130 163,90	P20130 299,90	PVM20130 369,90

Gegenkasten **Form B**



EDELSTAHL matt



ALUMINIUM EV1



EDELSTAHL poliert



PVD Messinggelb

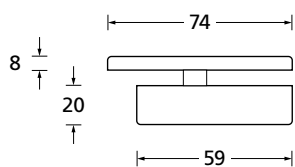
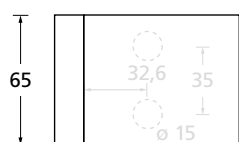
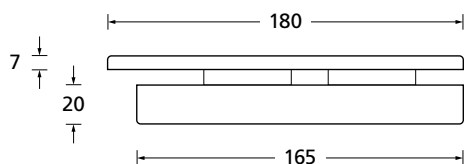
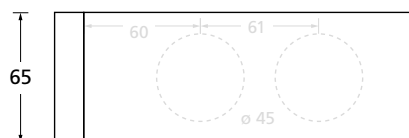

Gegenkasten lang



Gegenkasten kurz

	Edelstahl matt	Aluminium EV1	Edelstahl poliert	PVD Messinggelb
	€ exkl. MwSt.	€ exkl. MwSt.	€ exkl. MwSt.	€ exkl. MwSt.
Gegenkasten Form B				
lang	20231L 79,90	30231L 69,90	P20231L 119,90	PVM20231L 139,90
kurz	20231 71,90	30231 61,90	P20231 111,90	PVM20231 131,90
Standflügelset Form B inkl. 3-tlg. Glastürbändern, Rahmenteile für Holzzargen und Türfeststeller				
Standflügelset lang	A20230L 187,90	R30230L 171,90	AP20230L 307,90	APVM20230L 377,90
Standflügelset kurz	A20230 179,90	R30230 163,90	AP20230 299,90	APVM20230 369,90

Glastürband **3-teilig** abgerundet inkl. Rahmenteil für Holzzarge

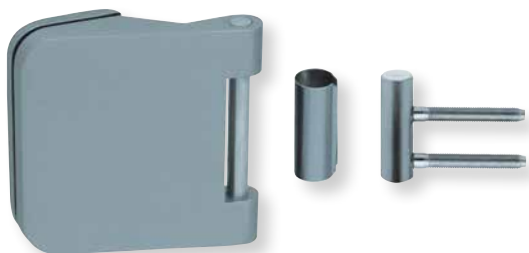

Glastürband 3-teilig abgerundet
wie EDELSTAHL matt

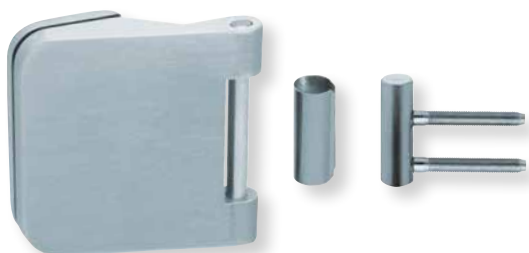

Glastürband 3-teilig abgerundet
ALUMINIUM EV1

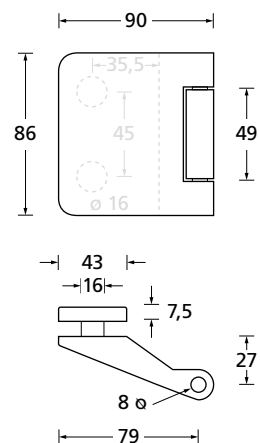

wie Edelstahl matt Aluminium EV1

Glastürband	€ exkl. MwSt.		€ exkl. MwSt.	
		Paar		Paar
3-teilig abgerundet	20149	57,90	201492	57,90



Glastürband **3-teilig** eckig inkl. Rahmenteil für Holzzarge

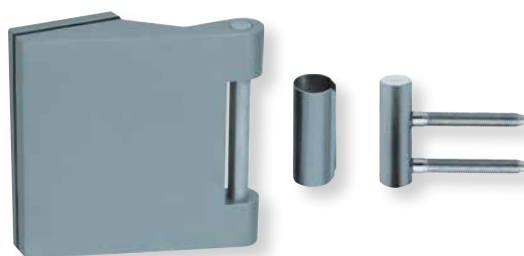

Glastürband 3-teilig eckig
wie EDELSTAHL matt

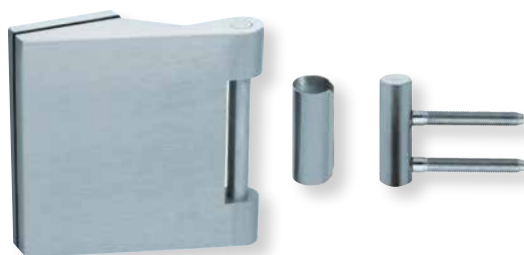

Glastürband 3-teilig eckig
ALUMINIUM EV1

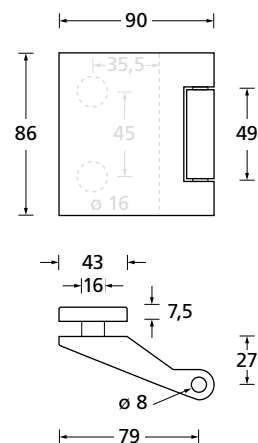

wie Edelstahl matt Aluminium EV1

Glastürband	€ exkl. MwSt.		€ exkl. MwSt.	
		Paar		Paar
3-teilig eckig	20139	57,90	201392	57,90

Glastürband **3-teilig** inkl. Rahmenteil für Holzzarge

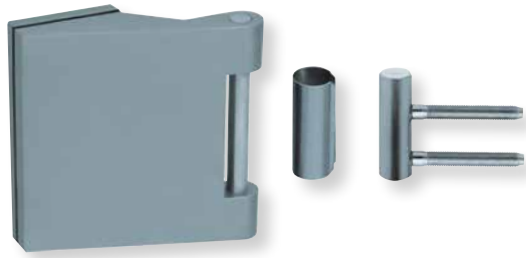

Glastürband 3-teilig massiv
EDELSTAHL matt

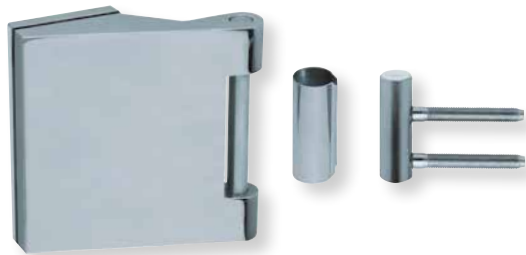

Glastürband 3-teilig massiv
EDELSTAHL poliert

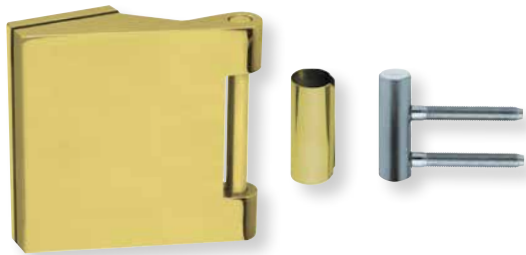

Glastürband 3-teilig massiv
PVD Messinggelb

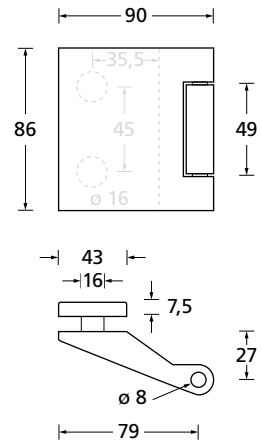

	Edelstahl matt	Edelstahl poliert	PVD Messinggelb
Glastürband	€ exkl. MwSt.	€ exkl. MwSt.	€ exkl. MwSt.
3-teilig massiv	Paar 20129 77,90	Paar P20129 117,90	Paar PVM10124 137,90



Glastürband **3-teilig** flach inkl. Rahmenteil für Holzzarge



Glastürband 3-teilig flach
EDELSTAHL matt

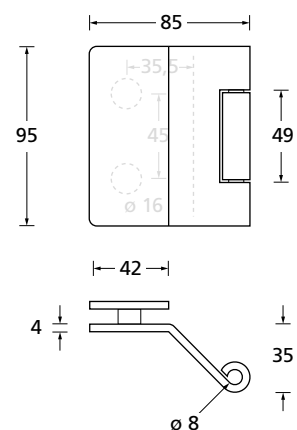

Edelstahl matt

Glastürband		€ exkl. MwSt.
3-teilig flach		Paar
	20129F	57,90

Glastürband **2-teilig** abgerundet



Glastürband 2-teilig abgerundet
wie EDELSTAHL matt



Glastürband 2-teilig abgerundet
ALUMINIUM EV1



Glastürband 2-teilig abgerundet
verchromt

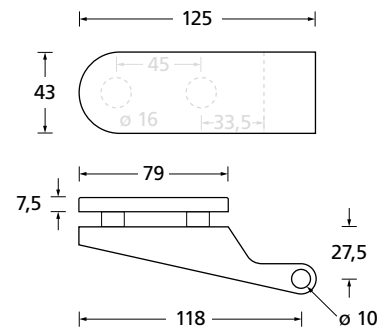
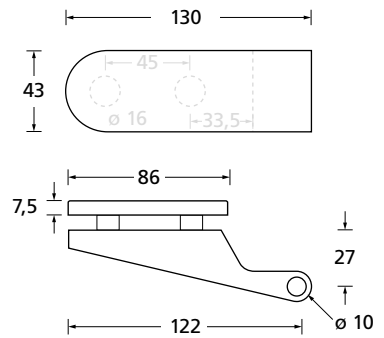

Glastürband	wie Edelstahl matt		Aluminium EV1		verchromt	
	10148	€ exkl. MwSt. Paar 77,90	101482	€ exkl. MwSt. Paar 77,90	P10118	€ exkl. MwSt. Paar 87,90
2-teilig abgerundet						



Glastürband **2-teilig** eckig



Glastürband 2-teilig eckig
wie EDELSTAHL matt



Glastürband 2-teilig eckig
ALUMINIUM EV1

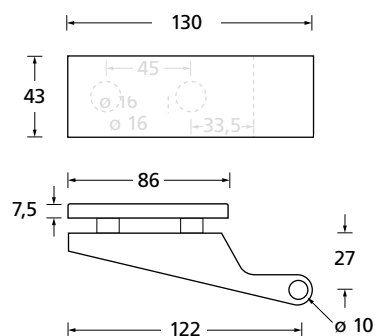

wie Edelstahl matt Aluminium EV1

Glastürband	€ exkl. MwSt.	Aluminium EV1	€ exkl. MwSt.
2-teilig eckig	Paar	Paar	Paar
	10138	101382	77,90
			77,90

Türfeststeller und Rollenschnäpper für Glastüren



Türfeststeller
EDELSTAHL matt

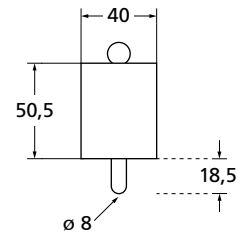

Türfeststeller
ALUMINIUM EV1

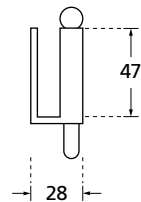

Türfeststeller
EDELSTAHL poliert

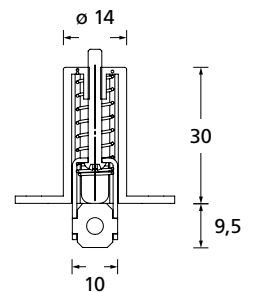

Türfeststeller
PVD Messinggelb



Rollenschnäpper

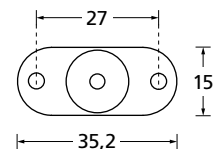

	Edelstahl matt	Aluminium EV1	Edelstahl poliert	PVD Messinggelb
Türfeststeller	€ exkl. MwSt. 10125 59,90	€ exkl. MwSt. 101252 53,90	€ exkl. MwSt. P10125 79,90	€ exkl. MwSt. PVM10125 109,90
Rollenschnäpper	€ exkl. MwSt. 10126 25,90			



Knaufzylinder für WC



Knaufzylinder
wie EDELSTAHL matt



Knaufzylinder
ALUMINIUM EV1



Knaufzylinder
verchromt



Knaufzylinder
PVD Messinggelb

Knauf auf Schlossseite:

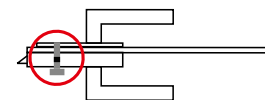
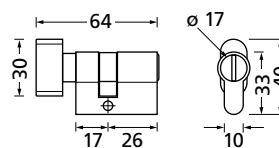

Knauf auf Schlossgegenseite:

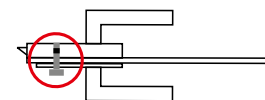
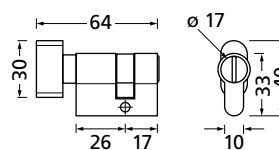

Knaufzylinder für WC	wie Edelstahl matt		Aluminium EV1		verchromt		PVD Messinggelb	
		€ exkl. MwSt.		€ exkl. MwSt.		€ exkl. MwSt.		€ exkl. MwSt.
26/17	10111	29,90	30111	29,90	P10111	33,90	PVM10111	37,90
17/26	10121	29,90	30121	29,90	P10121	33,90	PVM10121	37,90

Stoßgriffe für Glastüren

Edelstahl matt

272



Stoßgriffe SG 16 ø 25/19

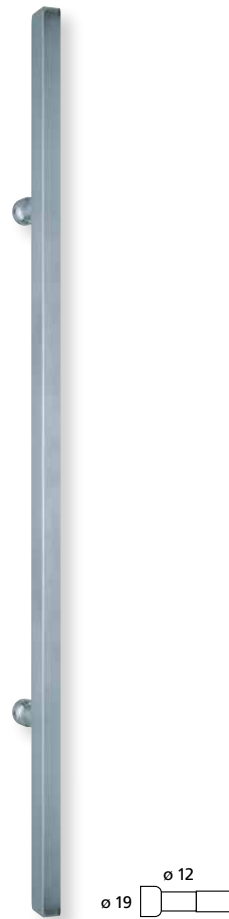

Stoßgriffe SG 16 ø 25/13

Edelstahl matt

SG 16 ø 25 / 19	€ exkl. MwSt.	
	Stk.	
ø 25 / BA 200 / GL 400	351613	27,90
ø 25 / BA 300 / GL 400	35169	27,90
ø 25 / BA 400 / GL 600	351610	32,90

Edelstahl matt

SG 16 25 / 13 eckig	€ exkl. MwSt.	
	Stk.	
25 / 13 / BA350 / GL600	15163E	45,90

ø = Durchmesser / BA = Bohrabstand / GL = Gesamtlänge



Montage-Sets und Muschelgriffe Edelstahl

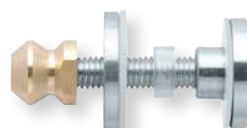

Montage-Set für Stoßgriffe

beidseitig (durchgebohrt)		€ exkl. MwSt.
		2 Stk.
für SG 16 ø 25 / 19	15108	8,90
Bohrung ø 12 mm		
für SG 16 25 / 13 eckig	15112	8,90
Bohrung ø 12 mm		

Montage-Set für Stoßgriffe

einseitig (durchgebohrt)		€ exkl. MwSt.
		2 Stk.
für SG 16 ø 25 / 19	15109	8,90
Bohrung ø 12 mm		
für SG 16 25 / 13 eckig	15113	8,90
Bohrung ø 12 mm		



Glastürmuschel rund
EDELSTAHL matt



Glastürmuschel konisch
EDELSTAHL matt

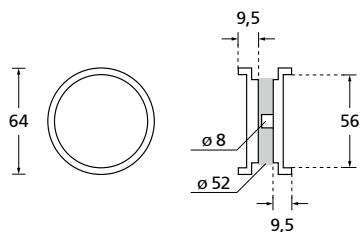

Glastürmuschel rund

Edelstahl matt		€ exkl. MwSt.
		Paar
rund	20036	25,90

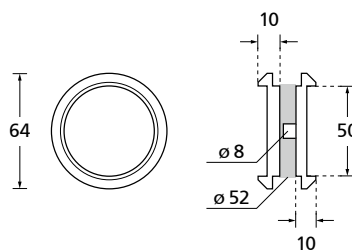

Glastürmuschel konisch

Edelstahl matt		€ exkl. MwSt.
		Paar
konisch	20037	25,90

Rahmenteile für Glastürbänder **3-teilig** für Holz- und Stahlzargen



Rahmenteil für Holzzarge

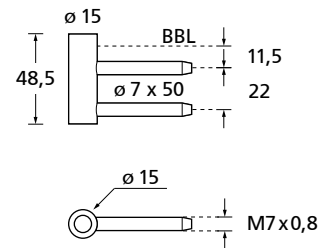

Rahmenteil für Stahlzarge

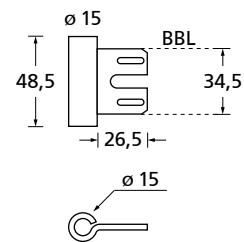

Aufschraub-Rahmenteil

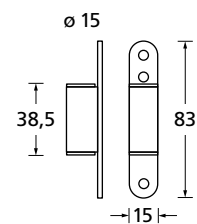

	für Holzzarge		für Stahlzarge		Aufschraub-Rahmenteil	
Rahmenteil	€ exkl. MwSt.		€ exkl. MwSt.		€ exkl. MwSt.	
für Glastürbänder	Stk.		Stk.		Stk.	
	10120	5,90	10122	5,90	101231	5,90

Aufschraub-Rahmenteil nicht mit Bandaufnahme der Standardbänder kompatibel. Bitte bei Bestellung angeben.



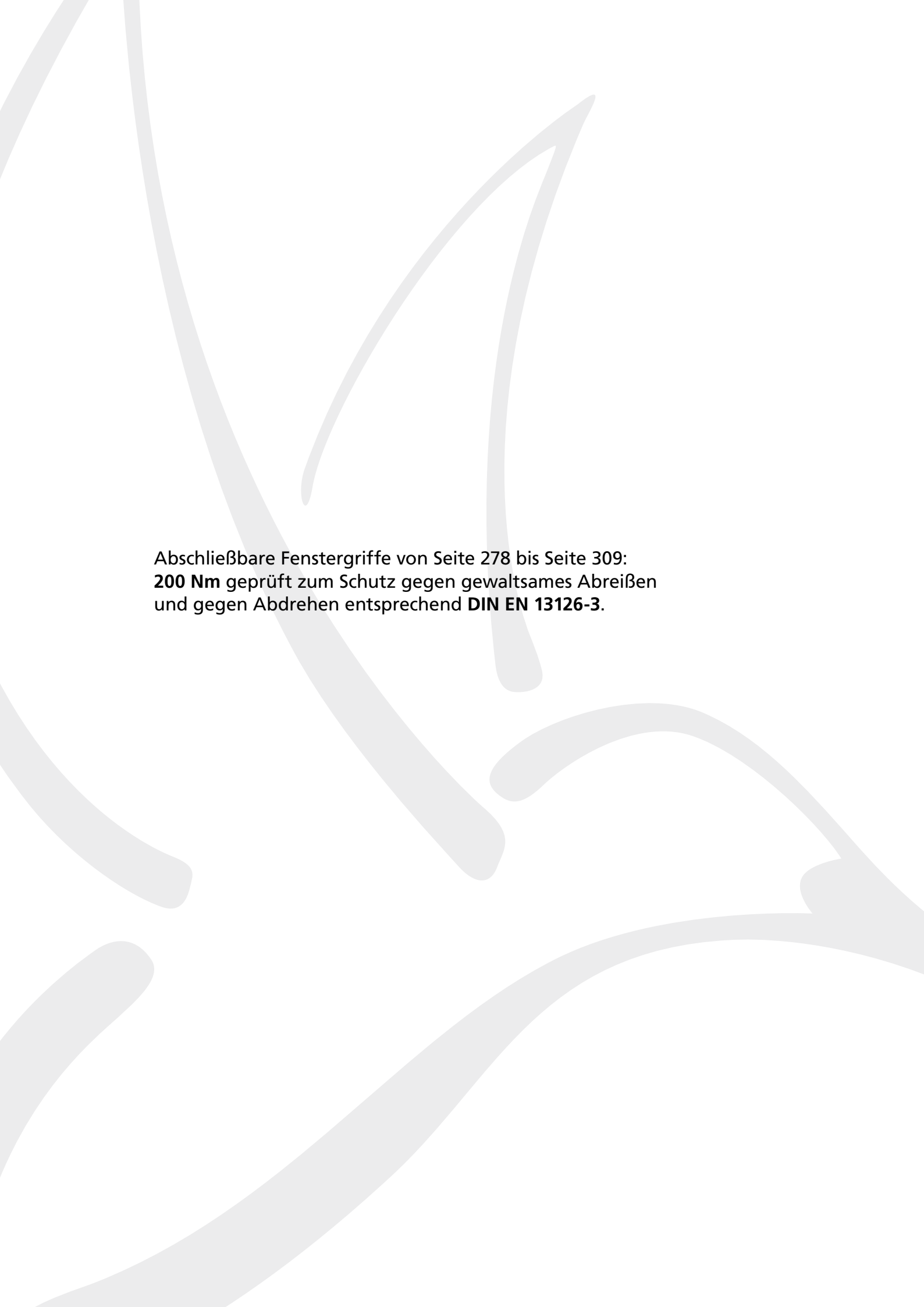

Abschließbare Fenstergriffe von Seite 278 bis Seite 309:
200 Nm geprüft zum Schutz gegen gewaltsames Abreißen
und gegen Abdrehen entsprechend **DIN EN 13126-3**.

Einleitung	ab	2
Kombinationsmöglichkeiten	ab	18
Schnellübersicht Formen	ab	20
Privat- und Objektbau GK3	ab	27
Feuerschutzgarnituren	ab	197
Rosetten/Knöpfe/Schilder	ab	211
Office Glastürbeschläge	ab	247
Glastürbeschläge	ab	253

Fenstergriffe

Sicherheit	ab	311
Stoßgriffe	ab	331
Muschelgriffe	ab	342
Türstopper	ab	347
Türfixierer	ab	349
Hausnummern	ab	350
Buchstaben und Hinweisschilder	ab	351

Schnellübersicht Fenstergriffe auf Ovalrosette Edelstahl matt



1002
ab Seite 284



1003
ab Seite 284



1005
ab Seite 284



1007
ab Seite 286



1008
ab Seite 286



1009
ab Seite 288



1010
ab Seite 286



1011
ab Seite 288



1012
ab Seite 288



1212
ab Seite 290



1013
ab Seite 290



1016
ab Seite 290



1019
ab Seite 292



1021
ab Seite 292



1023
ab Seite 292



1025
ab Seite 294



1026
ab Seite 294



1027
ab Seite 294



1066
ab Seite 296



1070
ab Seite 296



1074
ab Seite 296



1083
ab Seite 298



1085
ab Seite 298



1100
ab Seite 300



1101
ab Seite 298



1103
ab Seite 300



1104
ab Seite 300



1106
ab Seite 302



1107
ab Seite 302



1108
ab Seite 302



1109
ab Seite 304



1173
ab Seite 304



1174
ab Seite 304



1200
ab Seite 306



1206
ab Seite 306



1275
ab Seite 306



1X74
ab Seite 308

Schnellübersicht Fenstergriffe auf Ovalrosette Edelstahl poliert



1002
ab Seite 284



1003
ab Seite 284



1005
ab Seite 284



1007
ab Seite 286



1008
ab Seite 286



1009
ab Seite 288



1010
ab Seite 286



1212
ab Seite 290



1013
ab Seite 290



1016
ab Seite 290



1021
ab Seite 292



1023
ab Seite 292



1025
ab Seite 294



1026
ab Seite 294



1027
ab Seite 294



1070
ab Seite 296



1074
ab Seite 296



1083
ab Seite 298



1085
ab Seite 298



1100
ab Seite 300



1101
ab Seite 298



1103
ab Seite 300



1104
ab Seite 300



1106
ab Seite 302



1107
ab Seite 302



1108
ab Seite 302



1109
ab Seite 304



1173
ab Seite 304



1174
ab Seite 304



1200
ab Seite 306



1275
ab Seite 306

Schnellübersicht Fenstergriffe auf Ovalrosette PVD Messinggelb



1002
ab Seite 284



1005
ab Seite 284



1008
ab Seite 286



1016
ab Seite 290



1021
ab Seite 292



1025
ab Seite 294



1026
ab Seite 294



1083
ab Seite 298



1085
ab Seite 298



1103
ab Seite 300



Fenstergriffe auf eckiger Rosette PVD Messinggelb



1002
ab Seite 284



1005
ab Seite 284



1008
ab Seite 286



1016
ab Seite 290



1021
ab Seite 292



1025
ab Seite 294



1026
ab Seite 294



1083
ab Seite 298



1085
ab Seite 298



1103
ab Seite 300

Fenstergriffe

Edelstahl

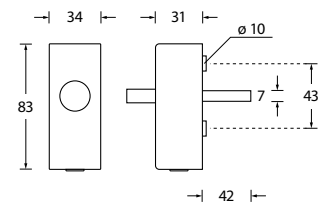
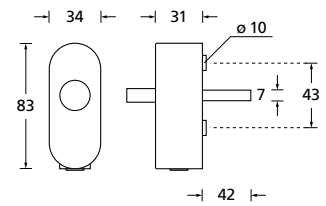
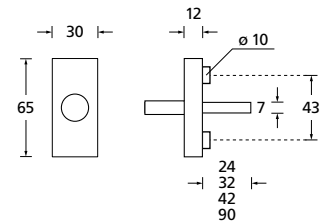
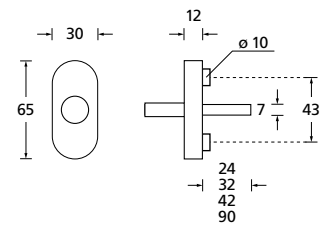
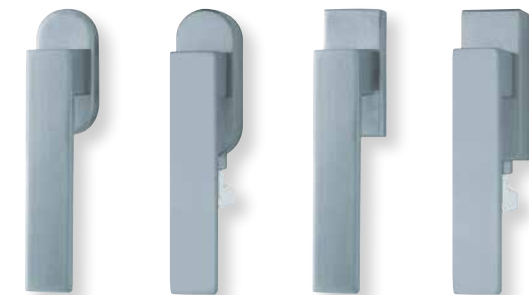



Form 1002

	Edelstahl matt		Edelstahl poliert		PVD Messinggelb	
Fensterolive		€ exkl. MwSt.		€ exkl. MwSt.		€ exkl. MwSt.
oval	100241	26,90	P100241	30,90	PVM100241	34,90
oval abschließbar	O10027	72,90	OP10027	76,90	OPVM10027	80,90
eckig	E100241	32,90	EP100241	36,90	EPVM100241	40,90
eckig abschließbar	E10027	78,90	EP10027	82,90	EPVM10027	86,90

Form 1003

	Edelstahl matt		Edelstahl poliert	
Fensterolive		€ exkl. MwSt.		€ exkl. MwSt.
oval	100341	26,90	P100341	30,90
oval abschließbar	O10037	72,90	OP10037	76,90
eckig	E100341	32,90	EP100341	36,90
eckig abschließbar	E10037	78,90	EP10037	82,90

Form 1005

	Edelstahl matt		Edelstahl poliert		PVD Messinggelb	
Fensterolive		€ exkl. MwSt.		€ exkl. MwSt.		€ exkl. MwSt.
oval	100541	28,90	P100541	32,90	PVM100541	36,90
oval abschließbar	O10057	74,90	OP10057	78,90	OPVM10057	82,90
eckig	E100541	34,90	EP100541	38,90	EPVM100541	42,90
eckig abschließbar	E10057	80,90	EP10057	84,90	EPVM10057	88,90

Standard-Stiftlängen unverschießbar: 32 (24/42/90) mm, abschließbar gleichschließend: 42 mm.
Aufpreis für individuell gekürzt: € 3,00

Fenstergriffe

Edelstahl

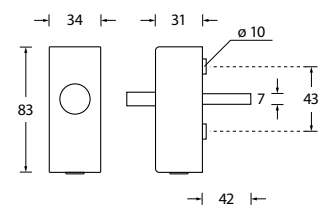
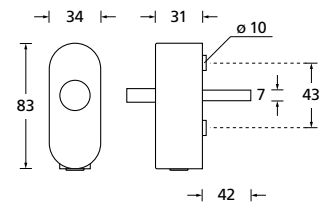
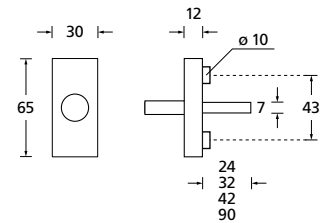
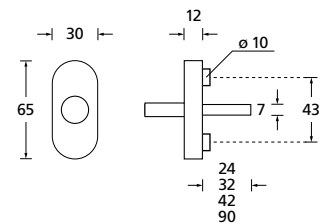



Form 1007

Fensterolive	Edelstahl matt		Edelstahl poliert	
		€ exkl. MwSt.		€ exkl. MwSt.
oval	100741	27,90	P100741	29,90
oval abschließbar	O10077	73,90	OP10077	75,90
eckig	E100741	33,90	EP100741	35,90
eckig abschließbar	E10077	79,90	EP10077	81,90

Form 1008

Fensterolive	Edelstahl matt		Edelstahl poliert		PVD Messinggelb	
		€ exkl. MwSt.		€ exkl. MwSt.		€ exkl. MwSt.
oval	100841	26,90	P100841	30,90	PVM100841	34,90
oval abschließbar	O10087	72,90	OP10087	76,90	OPVM10087	80,90
eckig	E100841	32,90	EP100841	36,90	EPVM100841	40,90
eckig abschließbar	E10087	78,90	EP10087	82,90	EPVM10087	86,90

Form 1010

Fensterolive	Edelstahl matt		Edelstahl poliert	
		€ exkl. MwSt.		€ exkl. MwSt.
oval	101041	22,90	P101041	26,90
oval abschließbar	O10107	68,90	OP10107	72,90
eckig	E101041	28,90	EP101041	32,90
eckig abschließbar	E10107	74,90	EP10107	78,90

Standard-Stiftlängen unverschießbar: 32 (24/42/90) mm, abschließbar gleichschließend: 42 mm.
Aufpreis für individuell gekürzt: € 3,00

Fenstergriffe Edelstahl

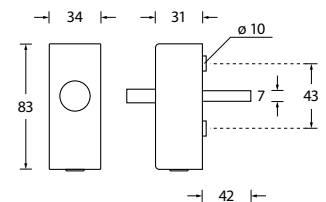
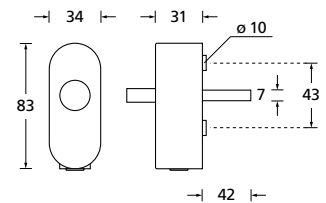
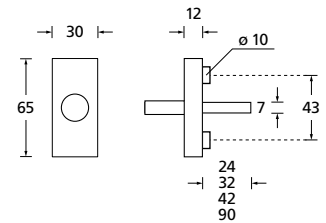
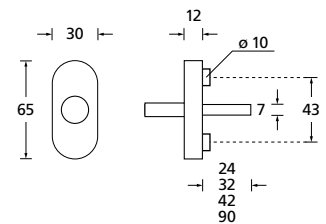



Form 1009

Fensterolive	Edelstahl matt		Edelstahl poliert	
		€ exkl. MwSt.		€ exkl. MwSt.
oval	100941	26,90	P100941	30,90
oval abschließbar	O10097	72,90	OP10097	76,90
eckig	E100941	32,90	EP100941	36,90
eckig abschließbar	E10097	78,90	EP10097	82,90

Form 1011

Fensterolive	Edelstahl matt	
		€ exkl. MwSt.
oval	101141	26,90
oval abschließbar	O10117	72,90
eckig	E101141	32,90
eckig abschließbar	E10117	78,90

Form 1012

Fensterolive	Edelstahl matt	
		€ exkl. MwSt.
oval	101241	26,90
oval abschließbar	O10127	72,90
eckig	E101241	32,90
eckig abschließbar	E10127	78,90

Fenstergriffe

Edelstahl

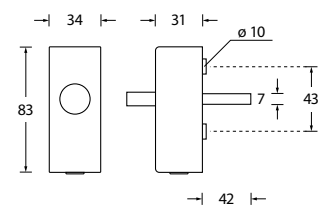
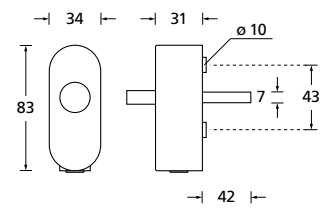
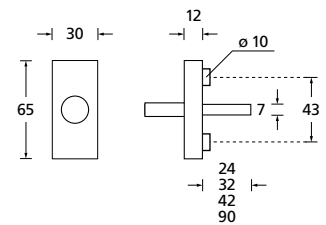
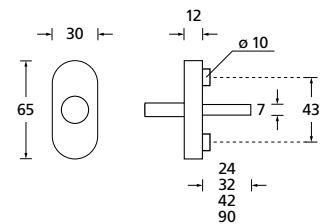



Form 1212

	Edelstahl matt		Edelstahl poliert	
Fensterolive		€ exkl. MwSt.		€ exkl. MwSt.
oval	121241	27,90	P121241	29,90
oval abschließbar	O12127	73,90	OP12127	75,90
eckig	E121241	33,90	EP121241	35,90
eckig abschließbar	E12127	79,90	EP12127	81,90

Form 1013

	Edelstahl matt		Edelstahl poliert	
Fensterolive		€ exkl. MwSt.		€ exkl. MwSt.
oval	101341	27,90	P101341	29,90
oval abschließbar	O10137	73,90	OP10137	75,90
eckig	E101341	33,90	EP101341	35,90
eckig abschließbar	E10137	79,90	EP10137	81,90

Form 1016

	Edelstahl matt		Edelstahl poliert		PVD Messinggelb	
Fensterolive		€ exkl. MwSt.		€ exkl. MwSt.		€ exkl. MwSt.
oval	101641	28,90	P101641	32,90	PVM101641	36,90
oval abschließbar	O10167	74,90	OP10167	78,90	OPVM10167	82,90
eckig	E101641	34,90	EP101641	38,90	EPVM101641	42,90
eckig abschließbar	E10167	80,90	EP10167	84,90	EPVM10167	88,90

Standard-Stiftlängen unverschiebbar: 32 (24/42/90) mm, abschließbar gleichschließend: 42 mm.
Aufpreis für individuell gekürzt: € 3,00

Fenstergriffe

Edelstahl

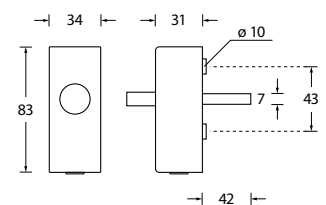
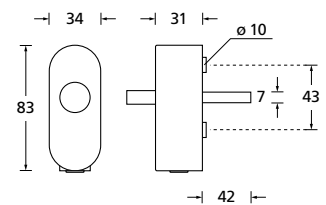
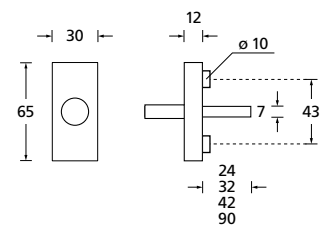
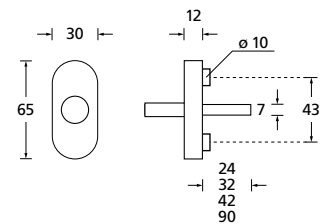



Form 1019

Edelstahl matt

Fensterolive		€ exkl. MwSt.
oval	101941	26,90
oval abschließbar	O10197	72,90
eckig	E101941	32,90
eckig abschließbar	E10197	78,90

Form 1021

Edelstahl matt

Edelstahl poliert

PVD Messinggelb

Fensterolive		€ exkl. MwSt.		€ exkl. MwSt.		€ exkl. MwSt.
oval	102141	30,90	P102141	34,90	PVM102141	38,90
oval abschließbar	O10217	76,90	OP10217	80,90	OPVM10217	84,90
eckig	E102141	36,90	EP102141	40,90	EPVM102141	44,90
eckig abschließbar	E10217	82,90	EP10217	86,90	EPVM10217	90,90

Form 1023

Edelstahl matt

Edelstahl poliert

Fensterolive		€ exkl. MwSt.		€ exkl. MwSt.
oval	102341	26,90	P102341	30,90
oval abschließbar	O10237	72,90	OP10237	76,90
eckig	E102341	32,90	EP102341	36,90
eckig abschließbar	E10237	78,90	EP10237	82,90

Fenstergriffe

Edelstahl

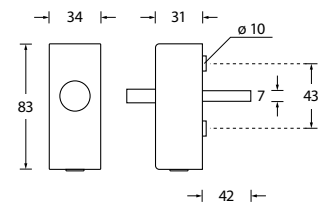
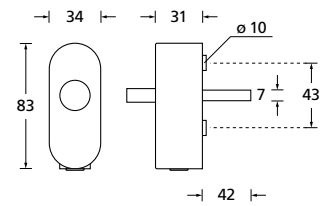
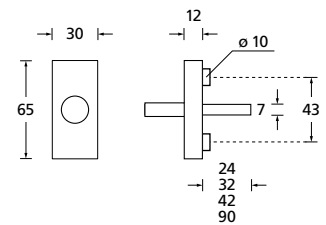
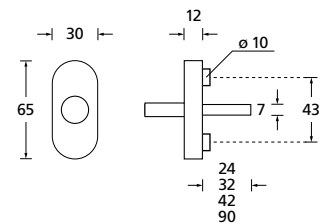



Form 1025

	Edelstahl matt		Edelstahl poliert		PVD Messinggelb	
Fensterolive		€ exkl. MwSt.		€ exkl. MwSt.		€ exkl. MwSt.
oval	102541	28,90	P102541	32,90	PVM102541	36,90
oval abschließbar	O10257	74,90	OP10257	78,90	OPVM10257	82,90
eckig	E102541	34,90	EP102541	38,90	EPVM102541	42,90
eckig abschließbar	E10257	80,90	EP10257	84,90	EPVM10257	88,90

Form 1026

	Edelstahl matt		Edelstahl poliert		PVD Messinggelb	
Fensterolive		€ exkl. MwSt.		€ exkl. MwSt.		€ exkl. MwSt.
oval	102641	28,90	P102641	32,90	PVM102641	36,90
oval abschließbar	O10267	74,90	OP10267	78,90	OPVM10267	82,90
eckig	E102641	34,90	EP102641	38,90	EPVM102641	42,90
eckig abschließbar	E10267	80,90	EP10267	84,90	EPVM10267	88,90

Form 1027

	Edelstahl matt		Edelstahl poliert	
Fensterolive		€ exkl. MwSt.		€ exkl. MwSt.
oval	102741	28,90	P102741	32,90
oval abschließbar	O10277	74,90	OP10277	78,90
eckig	E102741	34,90	EP102741	38,90
eckig abschließbar	E10277	80,90	EP10277	84,90

Fenstergriffe

Edelstahl

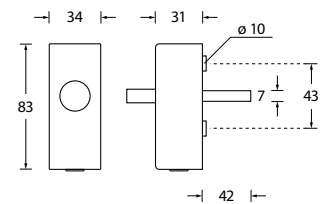
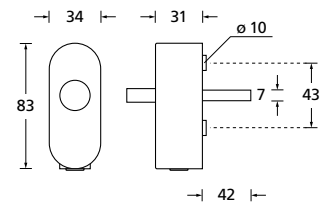
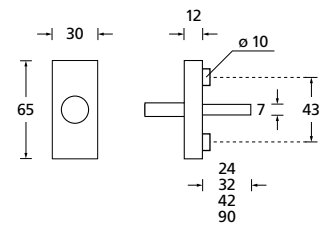
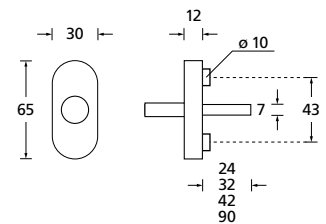
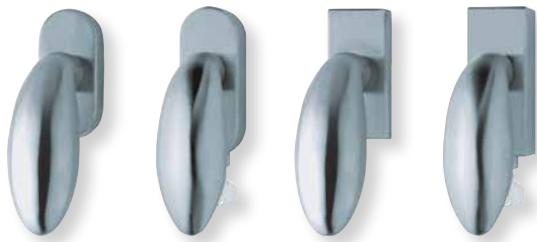



Form 1066

Edelstahl matt

Fensterolive		€ exkl. MwSt.
oval	106641	28,90
oval abschließbar	O10667	74,90
eckig	E106641	34,90
eckig abschließbar	E10667	80,90

Form 1070

Edelstahl matt

Edelstahl poliert

Fensterolive		€ exkl. MwSt.		€ exkl. MwSt.
oval	107041	26,90	P107041	30,90
oval abschließbar	O10707	72,90	OP10707	76,90
eckig	E107041	32,90	EP107041	36,90
eckig abschließbar	E10707	78,90	EP10707	82,90

Form 1074

Edelstahl matt

Edelstahl poliert

Fensterolive		€ exkl. MwSt.		€ exkl. MwSt.
oval	107441	22,90	P107441	26,90
oval abschließbar	O10747	68,90	OP10747	72,90
eckig	E107441	28,90	EP107441	32,90
eckig abschließbar	E10747	74,90	EP10747	78,90

Fenstergriffe

Edelstahl

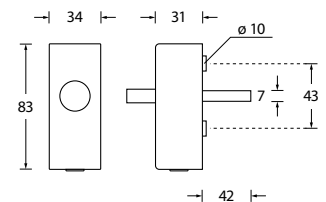
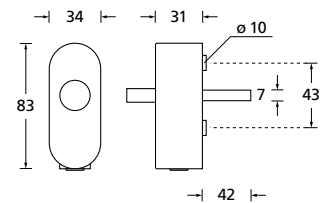
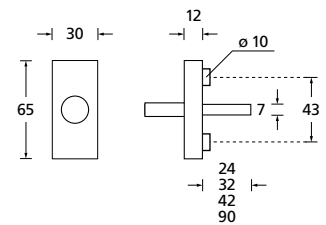
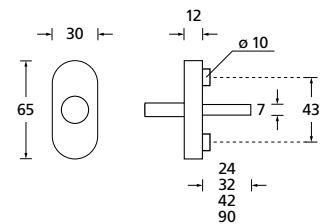



Form 1083

	Edelstahl matt		Edelstahl poliert		PVD Messinggelb	
Fensterolive	€ exkl. MwSt.		€ exkl. MwSt.		€ exkl. MwSt.	
oval	108341	26,90	P108341	30,90	PVM108341	34,90
oval abschließbar	O10837	72,90	OP10837	76,90	OPVM10837	80,90
eckig	E108341	32,90	EP108341	36,90	EPVM108341	40,90
eckig abschließbar	E10837	78,90	EP10837	82,90	EPVM10837	86,90

Form 1085

	Edelstahl matt		Edelstahl poliert		PVD Messinggelb	
Fensterolive	€ exkl. MwSt.		€ exkl. MwSt.		€ exkl. MwSt.	
oval	108541	22,90	P108541	26,90	PVM108541	30,90
oval abschließbar	O10857	68,90	OP10857	72,90	OPVM10857	76,90
eckig	E108541	28,90	EP108541	32,90	EPVM108541	36,90
eckig abschließbar	E10857	74,90	EP10857	78,90	EPVM10857	82,90

Form 1101

	Edelstahl matt		Edelstahl poliert	
Fensterolive	€ exkl. MwSt.		€ exkl. MwSt.	
oval	110141	25,90	P110141	27,90
oval abschließbar	O11017	71,90	OP11017	73,90
eckig	E110141	31,90	EP110141	33,90
eckig abschließbar	E11017	77,90	EP11017	79,90

Standard-Stiftlängen unverschießbar: 32 (24/42/90) mm, abschließbar gleichschließend: 42 mm.
Aufpreis für individuell gekürzt: € 3,00

Fenstergriffe

Edelstahl

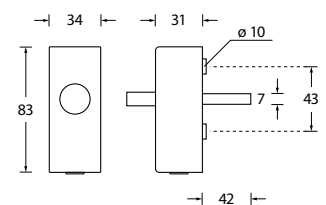
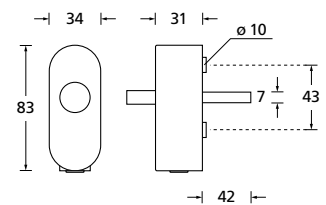
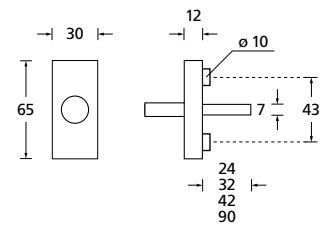
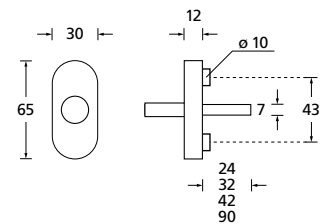



Form 1100

Fensterolive	Edelstahl matt		Edelstahl poliert	
		€ exkl. MwSt.		€ exkl. MwSt.
oval	110041	22,90	P110041	26,90
oval abschließbar	O11007	68,90	OP11007	72,90
eckig	E110041	28,90	EP110041	32,90
eckig abschließbar	E11007	74,90	EP11007	78,90

Form 1103

Fensterolive	Edelstahl matt		Edelstahl poliert		PVD Messinggelb	
		€ exkl. MwSt.		€ exkl. MwSt.		€ exkl. MwSt.
oval	110341	26,90	P110341	30,90	PVM110341	34,90
oval abschließbar	O11037	72,90	OP11037	76,90	OPVM11037	80,90
eckig	E110341	32,90	EP110341	36,90	EPVM110341	40,90
eckig abschließbar	E11037	78,90	EP11037	82,90	EPVM11037	86,90

Form 1104

Fensterolive	Edelstahl matt		Edelstahl poliert	
		€ exkl. MwSt.		€ exkl. MwSt.
oval	110441	22,90	P110441	26,90
oval abschließbar	O11047	68,90	OP11047	72,90
eckig	E110441	28,90	EP110441	32,90
eckig abschließbar	E11047	74,90	EP11047	78,90

Standard-Stiftlängen unverschiebbar: 32 (24/42/90) mm, abschließbar gleichschließend: 42 mm.
Aufpreis für individuell gekürzt: € 3,00

Fenstergriffe

Edelstahl

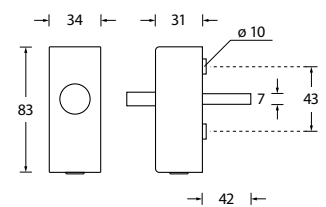
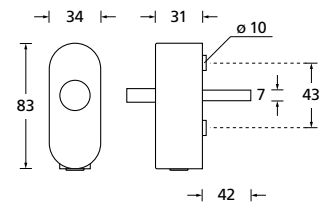
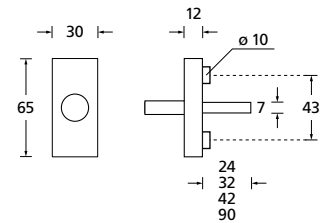
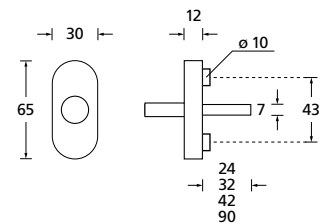



Form 1107

Fensterolive	Edelstahl matt		Edelstahl poliert	
		€ exkl. MwSt.		€ exkl. MwSt.
oval	110741	22,90	P110741	26,90
oval abschließbar	O11077	68,90	OP11077	72,90
eckig	E110741	28,90	EP110741	32,90
eckig abschließbar	E11077	74,90	EP11077	78,90

Form 1106

Fensterolive	Edelstahl matt		Edelstahl poliert	
		€ exkl. MwSt.		€ exkl. MwSt.
oval	110641	22,90	P110641	26,90
oval abschließbar	O11067	68,90	OP11067	72,90
eckig	E110641	28,90	EP110641	32,90
eckig abschließbar	E11067	74,90	EP11067	78,90

Form 1108

Fensterolive	Edelstahl matt		Edelstahl poliert	
		€ exkl. MwSt.		€ exkl. MwSt.
oval	110841	22,90	P110841	26,90
oval abschließbar	O11087	68,90	OP11087	72,90
eckig	E110841	28,90	EP110841	32,90
eckig abschließbar	E11087	74,90	EP11087	78,90

Standard-Stiftlängen unverschießbar: 32 (24/42/90) mm, abschließbar gleichschließend: 42 mm.
Aufpreis für individuell gekürzt: € 3,00

Fenstergriffe

Edelstahl

304

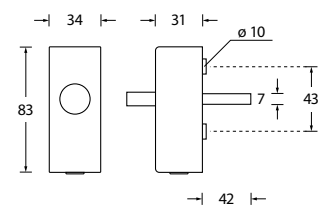
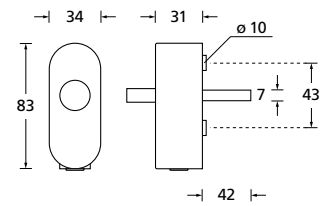
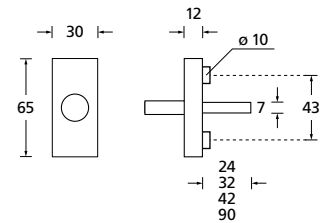
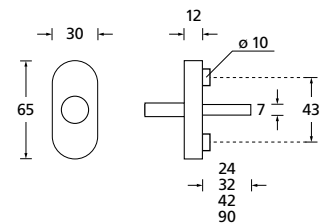



Form 1109

Fensterolive	Edelstahl matt		Edelstahl poliert	
		€ exkl. MwSt.		€ exkl. MwSt.
oval	110941	22,90	P110941	26,90
oval abschließbar	O11097	68,90	OP11097	72,90
eckig	E110941	28,90	EP110941	32,90
eckig abschließbar	E11097	74,90	EP11097	78,90

Form 1173

Fensterolive	Edelstahl matt		Edelstahl poliert	
		€ exkl. MwSt.		€ exkl. MwSt.
oval	117341	23,90	P117341	25,90
oval abschließbar	O11737	69,90	OP11737	71,90
eckig	E117341	29,90	EP117341	31,90
eckig abschließbar	E11737	75,90	EP11737	77,90

Form 1174

Fensterolive	Edelstahl matt		Edelstahl poliert	
		€ exkl. MwSt.		€ exkl. MwSt.
oval	117441	23,90	P117441	25,90
oval abschließbar	O11747	69,90	OP11747	71,90
eckig	E117441	29,90	EP117441	31,90
eckig abschließbar	E11747	75,90	EP11747	77,90

Standard-Stiftlängen unverschiebbar: 32 (24/42/90) mm, abschließbar gleichschließend: 42 mm.
Aufpreis für individuell gekürzt: € 3,00

Fenstergriffe

Edelstahl

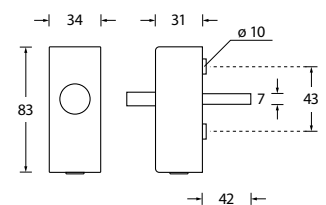
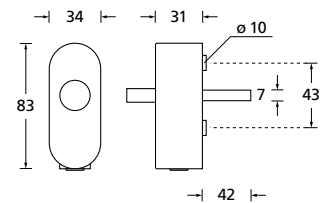
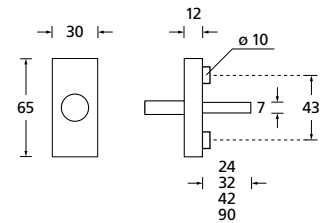
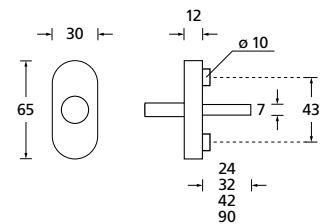



Form 1200

Fensterolive	Edelstahl matt		Edelstahl poliert	
		€ exkl. MwSt.		€ exkl. MwSt.
oval	120041	22,90	P120041	26,90
oval abschließbar	O12007	68,90	OP12007	72,90
eckig	E120041	28,90	EP120041	32,90
eckig abschließbar	E12007	74,90	EP12007	78,90

Form 1206

Fensterolive	Edelstahl matt	
		€ exkl. MwSt.
oval	120641	23,90
oval abschließbar	O12067	69,90
eckig	E120641	29,90
eckig abschließbar	E12067	75,90

Form 1275

Fensterolive	Edelstahl matt		Edelstahl poliert	
		€ exkl. MwSt.		€ exkl. MwSt.
oval	127541	25,90	P127541	27,90
oval abschließbar	O12757	71,90	OP12757	73,90
eckig	E127541	31,90	EP127541	33,90
eckig abschließbar	E12757	77,90	EP12757	79,90

Standard-Stiftlängen unverschießbar: 32 (24/42/90) mm, abschließbar gleichschließend: 42 mm.
Aufpreis für individuell gekürzt: € 3,00

Fenstergriffe

Edelstahl



308

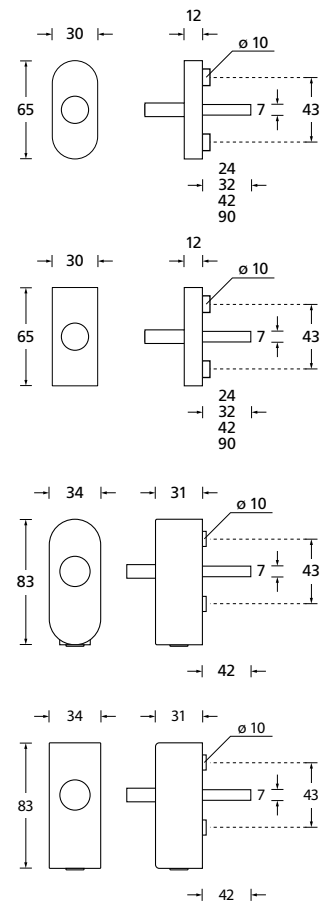



Form **1X74**

Edelstahl matt

Fensterolive		€ exkl. MwSt.
oval	1X7441	32,90
oval abschließbar	O1X747	78,90
eckig	E1X7441	38,90
eckig abschließbar	E1X747	84,90

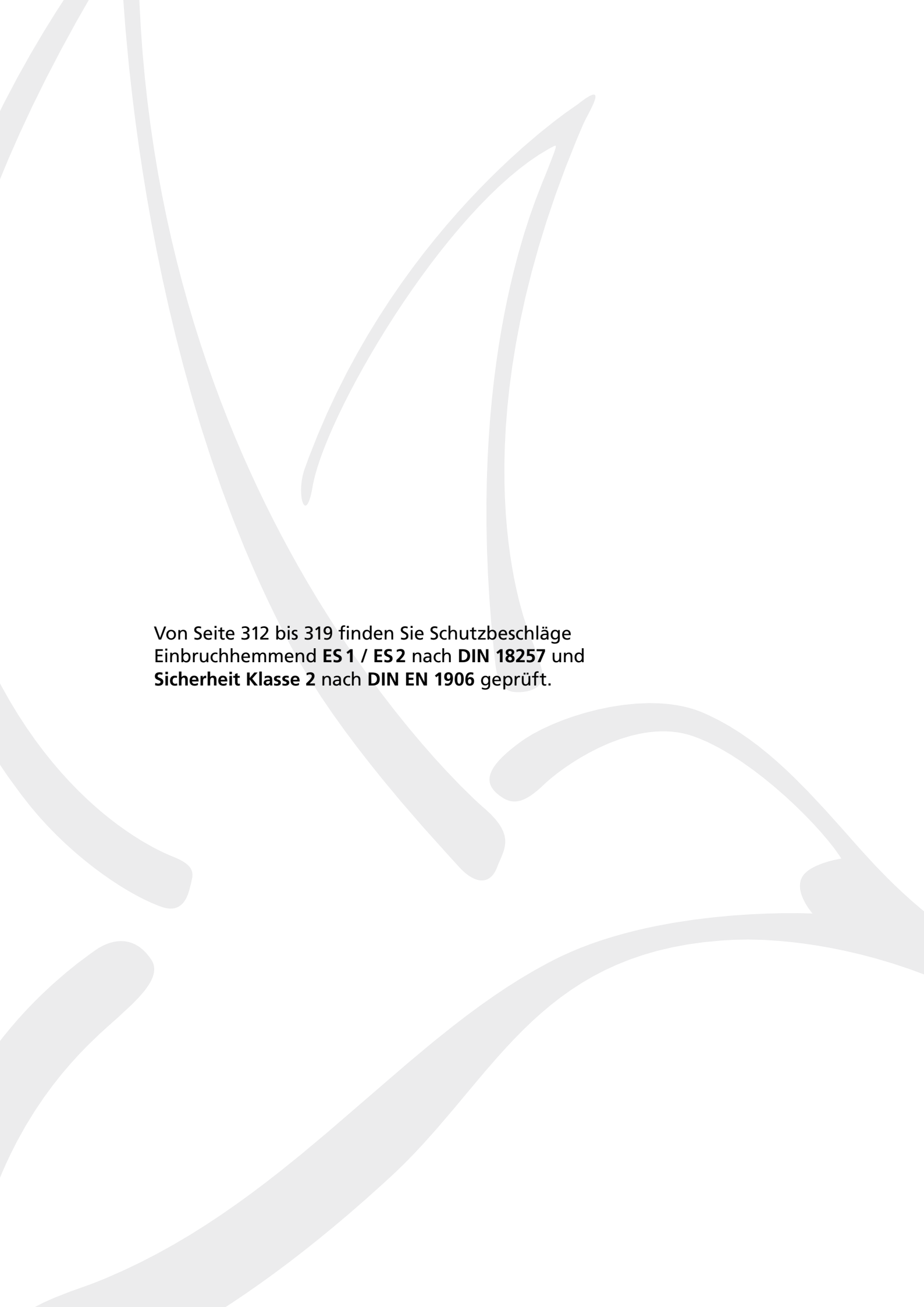

Von Seite 312 bis 319 finden Sie Schutzbeschläge
Einbruchhemmend **ES 1 / ES 2** nach **DIN 18257** und
Sicherheit Klasse 2 nach **DIN EN 1906** geprüft.

Einleitung	ab	2
Kombinationsmöglichkeiten	ab	18
Schnellübersicht Formen	ab	20
Privat- und Objektbau GK3	ab	27
Feuerschutzgarnituren	ab	197
Rosetten/Knöpfe/Schilder	ab	211
Office Glastürbeschläge	ab	247
Glastürbeschläge	ab	253
Fenstergriffe	ab	277

Sicherheit

Stoßgriffe	ab	331
Muschelgriffe	ab	342
Türstopper	ab	347
Türfixierer	ab	349
Hausnummern	ab	350
Buchstaben und Hinweisschilder	ab	351

Schutzbeschlag

Griffknopf/Drücker

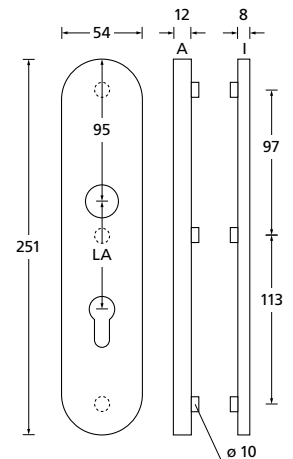

Schutzbeschlag Edelstahl matt

ES 1 DIN 18257 (SK 2 DIN EN 1906) € exkl. MwSt.

PZ - LA 72 mm	39000GES1	137,90
PZ - LA 92 mm	39001GES1	137,90
RZ - LA 78 mm	39006GES1	167,90

ÖNORM

PZ - LA 88 mm	3900230GES1	137,90
---------------	-------------	--------

Feuerschutz DIN 18273

PZ - LA 72 mm	39100GES1FS	161,90
---------------	-------------	--------

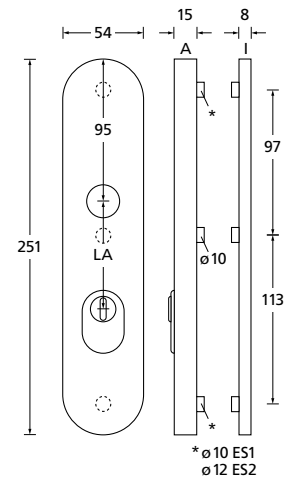

Zylinderüberstand
ES 1: 12 - 17 mm
ES 2: 11 - 14 mm

Schutzbeschlag mit Kernziehschutz Edelstahl matt

ES 1 DIN 18257 (SK 2 DIN EN 1906) € exkl. MwSt.

PZ - LA 72 mm	39010GES1	151,90
PZ - LA 92 mm	39011GES1	151,90

ÖNORM

PZ - LA 88 mm	3901230GES1	151,90
---------------	-------------	--------

Feuerschutz ÖNORM B 3859

PZ - LA 88 mm	3911230GES1FS	173,90
---------------	---------------	--------

Feuerschutz DIN 18273

PZ - LA 72 mm	39110GES1FS	173,90
---------------	-------------	--------

ES 2 DIN 18257 (SK 3 DIN EN 1906) € exkl. MwSt.

PZ - LA 72 mm	39010GES2	175,90
PZ - LA 92 mm	39011GES2	175,90

ÖNORM

PZ - LA 88 mm	3901230GES2	175,90
---------------	-------------	--------

Feuerschutz DIN 18273

PZ - LA 72 mm	39110GES2FS	199,90
---------------	-------------	--------

Standard-Türstärken: 35 - 55 mm, Aufpreis für Türstärken ab 55 mm: € 7,90. Standard-Türstärken Feuerschutz: 39 - 58 mm. Bei Bestellung bitte **immer** angeben. **Kombinierbar mit allen Drückerformen** (Feuerschutz auf Anfrage). **Inkl. Form 1106.**



Schutzbeschlag

Zylindrischer Knopf/Drücker

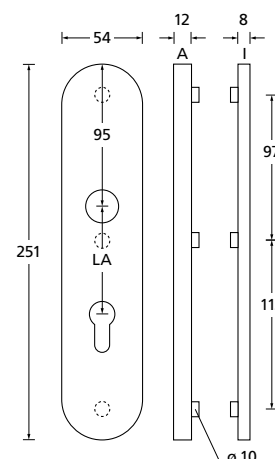

Schutzbeschlag Edelstahl matt

ES 1 DIN 18257 (SK 2 DIN EN 1906) € exkl. MwSt.

PZ - LA 72 mm	39000KES1	137,90
PZ - LA 92 mm	39001KES1	137,90
RZ - LA 78 mm	39006KES1	167,90

ÖNORM

PZ - LA 88 mm	3900230KES1	137,90
---------------	-------------	--------

Feuerschutz DIN 18273

PZ - LA 72 mm	39100KES1FS	161,90
---------------	-------------	--------

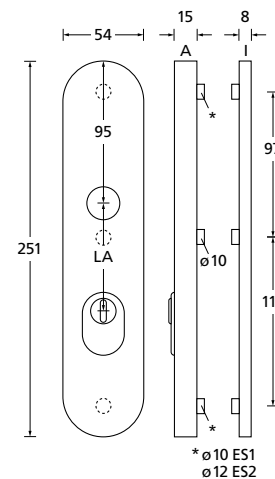

Schutzbeschlag mit Kernziehschutz Edelstahl matt

ES 1 DIN 18257 (SK 2 DIN EN 1906) € exkl. MwSt.

PZ - LA 72 mm	39010KES1	151,90
PZ - LA 92 mm	39011KES1	151,90

ÖNORM

PZ - LA 88 mm	3901230KES1	151,90
---------------	-------------	--------

Feuerschutz ÖNORM B 3859

PZ - LA 88 mm	3911230KES1FS	173,90
---------------	---------------	--------

Feuerschutz DIN 18273

PZ - LA 72 mm	39110KES1FS	173,90
---------------	-------------	--------

ES 2 DIN 18257 (SK 3 DIN EN 1906) € exkl. MwSt.

PZ - LA 72 mm	39010KES2	175,90
PZ - LA 92 mm	39011KES2	175,90

ÖNORM

PZ - LA 88 mm	3901230KES2	175,90
---------------	-------------	--------

Feuerschutz DIN 18273

PZ - LA 72 mm	39110KES2FS	199,90
---------------	-------------	--------

Zylinderüberstand
ES 1: 12 - 17 mm
ES 2: 11 - 14 mm

Standard-Türstärken: 35 - 55 mm, Aufpreis für Türstärken ab 55 mm: € 7,90. Standard-Türstärken Feuerschutz: 39 - 58 mm. Bei Bestellung bitte immer angeben. **Kombinierbar mit allen Drückerformen** (Feuerschutz auf Anfrage). **Inkl. Form 1106.**

Schutzbeschlag

Griffplatte/Drücker

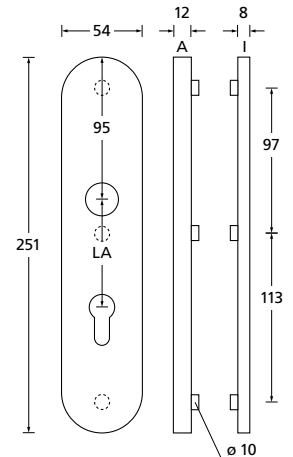

Schutzbeschlag Edelstahl matt

ES 1 DIN 18257 (SK2 DIN EN 1906) € exkl. MwSt.		
PZ - LA 72 mm	39000ES1	147,90
PZ - LA 92 mm	39001ES1	147,90

ÖNORM		
PZ - LA 88 mm	3900230ES1	147,90

Feuerschutz DIN 18273		
PZ - LA 72 mm	39100ES1FS	171,90

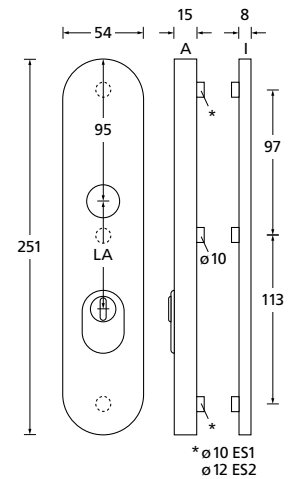

Zylinderüberstand
ES1: 12 - 17 mm
ES2: 11 - 14 mm

Schutzbeschlag mit Kernziehschutz Edelstahl matt

ES 1 DIN 18257 (SK2 DIN EN 1906) € exkl. MwSt.		
PZ - LA 72 mm	39010ES1	161,90
PZ - LA 92 mm	39011ES1	161,90

ES 2 DIN 18257 (SK3 DIN EN 1906) € exkl. MwSt.		
PZ - LA 72 mm	39010ES2	185,90
PZ - LA 92 mm	39011ES2	185,90

ÖNORM		
PZ - LA 88 mm	3901230ES1	161,90

ÖNORM		
PZ - LA 88 mm	3901230ES2	185,90

Feuerschutz ÖNORM B 3859		
PZ - LA 88 mm	3911230ES1FS	183,90

Feuerschutz DIN 18273		
PZ - LA 72 mm	39110ES2FS	209,90

Standard-Türstärken: 35 - 55 mm, Aufpreis für Türstärken ab 55 mm: € 7,90. Standard-Türstärken Feuerschutz: 39 - 58 mm. Bei Bestellung bitte **immer** angeben. **Kombinierbar mit allen Drückerformen** (Feuerschutz auf Anfrage). **Inkl. Form 1106.**



Schutzbeschlag II

Drücker/Drücker

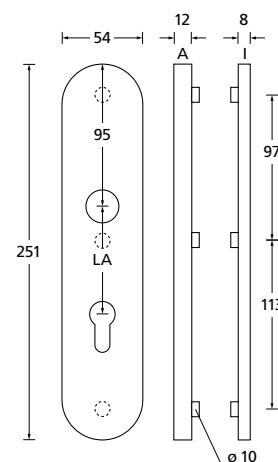

Schutzbeschlag II Edelstahl matt

ES 1 DIN 18257 (SK 2 DIN EN 1906) € exkl. MwSt.		
PZ - LA 72 mm	39003ES1	117,90
PZ - LA 92 mm	39004ES1	117,90
RZ - LA 78 mm	39007ES1	147,90

ÖNORM		
PZ - LA 88 mm	3900530ES1	117,90

Feuerschutz DIN 18273		
PZ - LA 72 mm	39003ES1FS	139,90

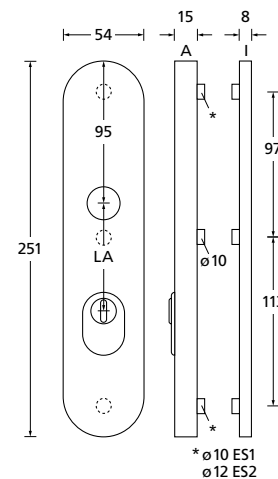

Schutzbeschlag II mit Kernziehschutz Edelstahl matt

ES 1 DIN 18257 (SK 2 DIN EN 1906) € exkl. MwSt.		
PZ - LA 72 mm	39013ES1	129,90
PZ - LA 92 mm	39014ES1	129,90

ÖNORM		
PZ - LA 88 mm	3901530ES1	129,90

Feuerschutz ÖNORM B 3859		
PZ - LA 88 mm	3911530ES1FS	153,90

Feuerschutz DIN 18273		
PZ - LA 72 mm	39113ES1FS	153,90

ES 2 DIN 18257 (SK 3 DIN EN 1906) € exkl. MwSt.		
PZ - LA 72 mm	39013ES2	151,90
PZ - LA 92 mm	39014ES2	151,90

ÖNORM		
PZ - LA 88 mm	3901530ES2	151,90

Feuerschutz DIN 18273		
PZ - LA 72 mm	39113ES2FS	175,90

Zylinderüberstand
ES 1: 12 - 17 mm
ES 2: 11 - 14 mm

Standard-Türstärken: 35 - 55 mm, Aufpreis für Türstärken ab 55 mm: € 7,90. Standard-Türstärken Feuerschutz: 39 - 58 mm. Bei Bestellung bitte **immer** angeben. **Kombinierbar mit allen Drückerformen** (Feuerschutz auf Anfrage). **Inkl. Form 1106.**

Schutzbeschlag

Griffknopf/Pullbloc® PZ-Halbgarnitur



Schutzbeschlag mit Kernziehschutz Edelstahl matt

SK2 DIN EN 1906 (ES 1 DIN 18257) € exkl. MwSt.
 PZ - LA 72 mm PB39016G 151,90

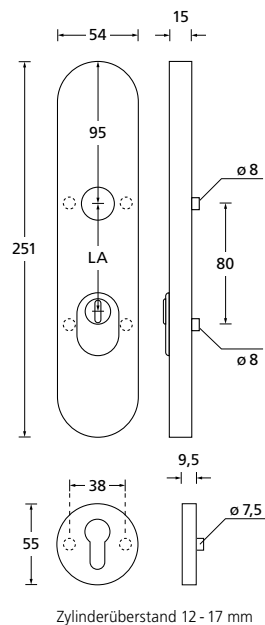

Griffplatte/Pullbloc® PZ-Halbgarnitur



Schutzbeschlag mit Kernziehschutz Edelstahl matt

SK2 DIN EN 1906 (ES 1 DIN 18257) € exkl. MwSt.
 PZ - LA 72 mm PB39016 161,90

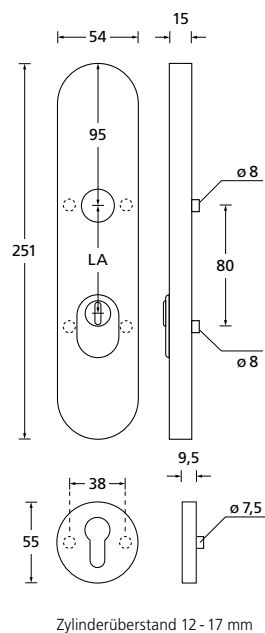

Standard-Türstärken: 35-55 mm, Aufpreis für Türstärken ab 55 mm: € 7,90. Bei Bestellung bitte **immer** angeben.
Kombinierbar mit allen Drückerformen. Inkl. Form 1106.



Schutzbeschlag

Zylindrischer Knopf/Pullbloc® PZ-Halbgarnitur

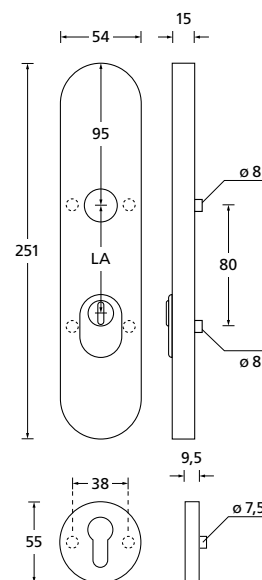

Schutzbeschlag mit Kernziehschutz Edelstahl matt

SK2 DIN EN 1906 (ES 1 DIN 18257) € exkl. MwSt.
PZ - LA 72 mm PB39016K 151,90

Zylinderüberstand 12 - 17 mm

Drücker/Pullbloc® PZ-Halbgarnitur

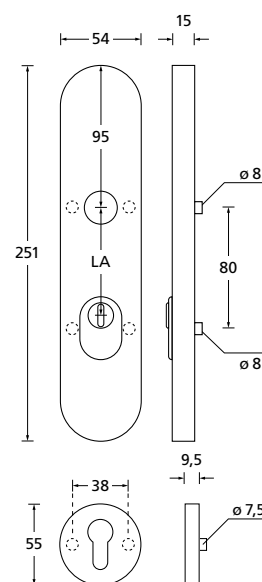

Schutzbeschlag mit Kernziehschutz Edelstahl matt

SK2 DIN EN 1906 (ES 1 DIN 18257) € exkl. MwSt.
PZ - LA 72 mm PB39019 129,90

Zylinderüberstand 12 - 17 mm

Standard-Türstärken: 35 - 55 mm, Aufpreis für Türstärken ab 55 mm: € 7,90. Bei Bestellung bitte **immer** angeben.
Kombinierbar mit allen Drückerformen. Inkl. Form 1106.

Schutzbeschlag

Griffknopf/PZ-Halbgarnitur

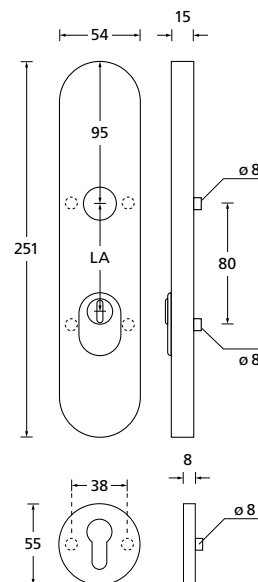

Zylinderüberstand 12-17 mm

Schutzbeschlag mit Kernziehschutz Edelstahl matt

SK2 DIN EN 1906 (ES 1 DIN 18257)

Feuerschutz DIN 18273

€ exkl. MwSt.

PZ - LA 72 mm

39116GES1FS

195,90

Griffplatte/PZ-Halbgarnitur

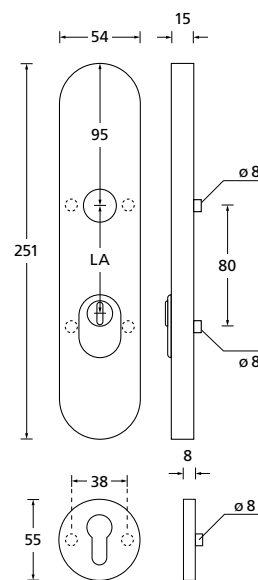

Zylinderüberstand 12-17 mm

Schutzbeschlag mit Kernziehschutz Edelstahl matt

SK2 DIN EN 1906 (ES 1 DIN 18257)

Feuerschutz DIN 18273

€ exkl. MwSt.

PZ - LA 72 mm

39116ES1FS

209,90

Standard-Türstärken: 39-58 mm, Aufpreis für Türstärken ab 55 mm: € 7,90. Bei Bestellung bitte **immer** angeben.
Inkl. Drückerformen 1106 (andere Formen auf Anfrage).



Schutzbeschlag

Zylindrischer Knopf/PZ-Halbgarnitur

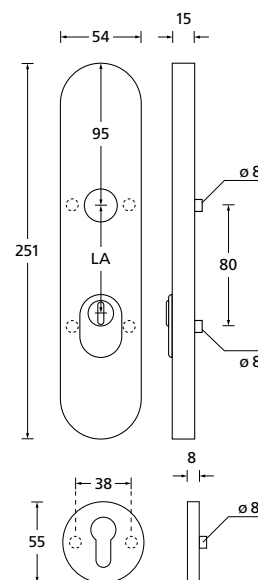

Zylinderüberstand 12 - 17 mm

Schutzbeschlag mit Kernziehschutz Edelstahl matt

SK2 DIN EN 1906 (ES 1 DIN 18257)

Feuerschutz DIN 18273 € exkl. MwSt.

PZ - LA 72 mm 39116KES1FS 195,90

Drücker/PZ-Halbgarnitur

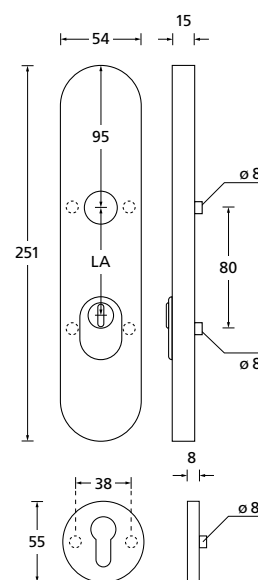

Zylinderüberstand 12 - 17 mm

Schutzbeschlag mit Kernziehschutz Edelstahl matt

SK2 DIN EN 1906 (ES 1 DIN 18257)

Feuerschutz DIN 18273 € exkl. MwSt.

PZ - LA 72 mm 39119ES1FS 195,90

Standard-Türstärken: 39 - 58 mm, Aufpreis für Türstärken ab 55 mm: € 7,90. Bei Bestellung bitte **immer** angeben.
Inkl. Drückerformen 1106 (andere Formen auf Anfrage).

Tresor

Griffplatte/Drücker

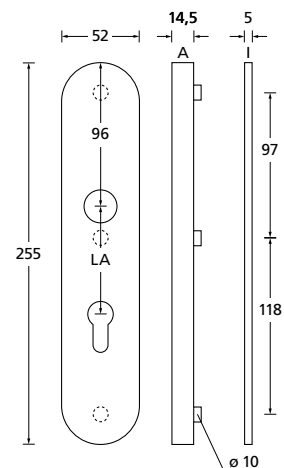

Tresor Edelstahl matt

		€ exkl. MwSt.
PZ - LA 72 mm	29000	89,90
PZ - LA 92 mm	29001	89,90
PZ - LA 88 mm	29002	89,90

320

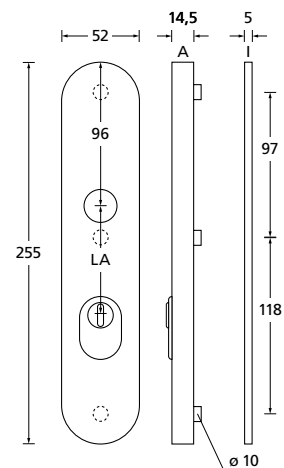

Zylinderüberstand 10 - 15 mm

Tresor mit Kernziehschutz Edelstahl matt

		€ exkl. MwSt.
PZ - LA 72 mm	29010	109,90
PZ - LA 92 mm	29011	109,90
PZ - LA 88 mm	29012	109,90

Standard-Türstärken: 40 - 60 mm. Bei Bestellung bitte **immer** angeben.
Kombinierbar mit allen Drückerformen. Inkl. Form 1106.



Tresor Außenschild

Griffplatte/Pullbloc® PZ-Halbgarnitur



Tresor Edelstahl matt

		€ exkl. MwSt.
PZ - LA 72 mm DIN R	PB29006R	90,90
PZ - LA 72 mm DIN L	PB29006L	90,90
PZ - LA 92 mm DIN R	PB29007R	90,90
PZ - LA 92 mm DIN L	PB29007L	90,90
PZ - LA 88 mm DIN R	PB29008R	90,90
PZ - LA 88 mm DIN L	PB29008L	90,90

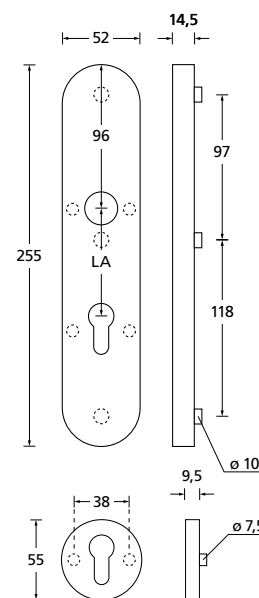

Tresor mit Kernziehschutz Edelstahl matt

		€ exkl. MwSt.
PZ - LA 72 mm DIN R	PB29016R	110,90
PZ - LA 72 mm DIN L	PB29016L	110,90
PZ - LA 92 mm DIN R	PB29017R	110,90
PZ - LA 92 mm DIN L	PB29017L	110,90
PZ - LA 88 mm DIN R	PB29018R	110,90
PZ - LA 88 mm DIN L	PB29018L	110,90

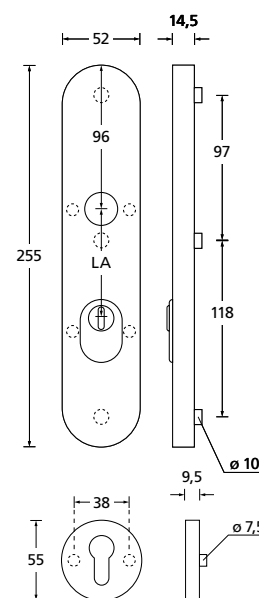

Zylinderüberstand 10 - 15 mm

Tresor

Griffknopf/Drücker

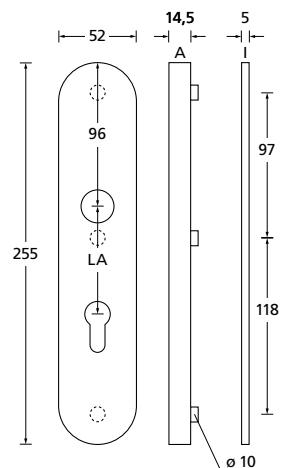

Tresor Edelstahl matt

		€ exkl. MwSt.
PZ - LA 72 mm	29000G	89,90
PZ - LA 92 mm	29001G	89,90
PZ - LA 88 mm	29002G	89,90

322

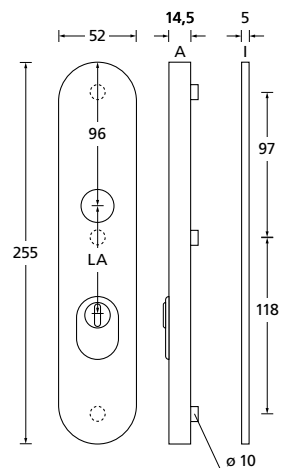

Zylinderüberstand 10 - 15 mm

Tresor mit Kernziehschutz Edelstahl matt

		€ exkl. MwSt.
PZ - LA 72 mm	29010G	109,90
PZ - LA 92 mm	29011G	109,90
PZ - LA 88 mm	29012G	109,90

Standard-Türstärken: 40 - 60 mm. Bei Bestellung bitte **immer** angeben.
Kombinierbar mit allen Drückerformen. Inkl. Form 1106.



Tresor Außenschild

Griffknopf/Pullbloc® PZ-Halbgarnitur

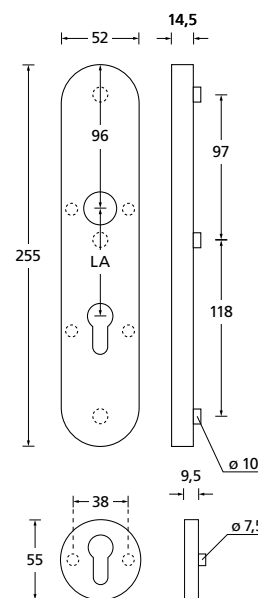

Tresor Edelstahl matt

		€ exkl. MwSt.
PZ - LA 72 mm DIN R	PB29006GR	90,90
PZ - LA 72 mm DIN L	PB29006GL	90,90
PZ - LA 92 mm DIN R	PB29007GR	90,90
PZ - LA 92 mm DIN L	PB29007GL	90,90
PZ - LA 88 mm DIN R	PB29008GR	90,90
PZ - LA 88 mm DIN L	PB29008GL	90,90

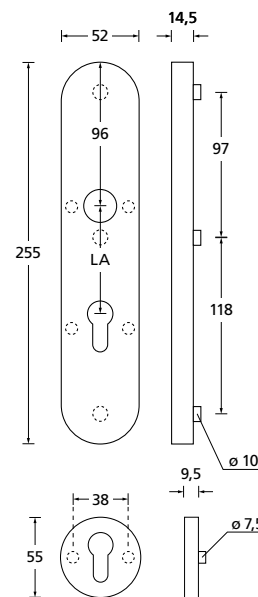

Tresor mit Kernziehschutz Edelstahl matt

		€ exkl. MwSt.
PZ - LA 72 mm DIN R	PB29016GR	110,90
PZ - LA 72 mm DIN L	PB29016GL	110,90
PZ - LA 92 mm DIN R	PB29017GR	110,90
PZ - LA 92 mm DIN L	PB29017GL	110,90
PZ - LA 88 mm DIN R	PB29018GR	110,90
PZ - LA 88 mm DIN L	PB29018GL	110,90

Zylinderüberstand 10 - 15 mm

Tresor II

Drücker/Drücker

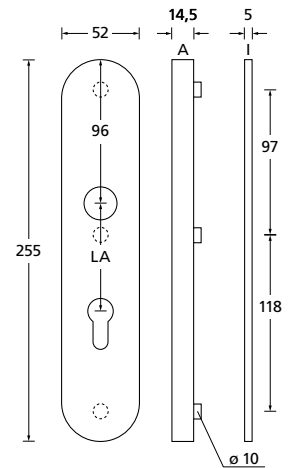

Tresor II Edelstahl matt

		€ exkl. MwSt.
PZ - LA 72 mm	29003	89,90
PZ - LA 92 mm	29004	89,90
PZ - LA 88 mm	29005	89,90

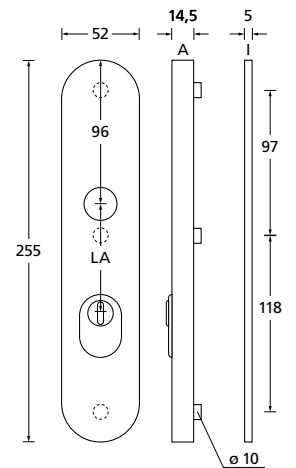

Tresor II mit Kernziehschutz Edelstahl matt

		€ exkl. MwSt.
PZ - LA 72 mm	29013	109,90
PZ - LA 92 mm	29014	109,90
PZ - LA 88 mm	29015	109,90

Zylinderüberstand 10 - 15 mm

Standard-Türstärken: 40 - 60 mm. Bei Bestellung bitte **immer** angeben.
Kombinierbar mit allen Drückerformen. Inkl. Form 1106.



Tresor Außenschild II

Drücker/Pullbloc® PZ-Halbgarnitur



Tresor Außenschild II Edelstahl matt

		€ exkl. MwSt.
PZ - LA 72 mm DIN R	PB29009R	90,90
PZ - LA 72 mm DIN L	PB29009L	90,90
PZ - LA 92 mm DIN R	PB29030R	90,90
PZ - LA 92 mm DIN L	PB29030L	90,90
PZ - LA 88 mm DIN R	PB29031R	90,90
PZ - LA 88 mm DIN L	PB29031L	90,90

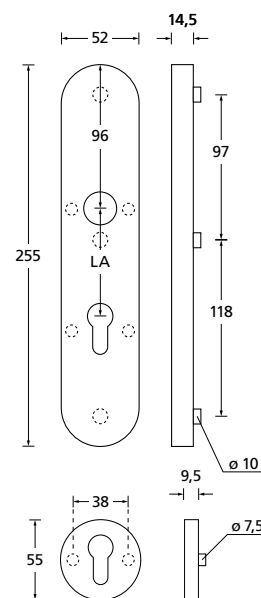

Tresor Außenschild II mit Kernziehschutz Edelstahl matt

		€ exkl. MwSt.
PZ - LA 72 mm DIN R	PB29019R	110,90
PZ - LA 72 mm DIN L	PB29019L	110,90
PZ - LA 92 mm DIN R	PB29020R	110,90
PZ - LA 92 mm DIN L	PB29020L	110,90
PZ - LA 88 mm DIN R	PB29021R	110,90
PZ - LA 88 mm DIN L	PB29021L	110,90

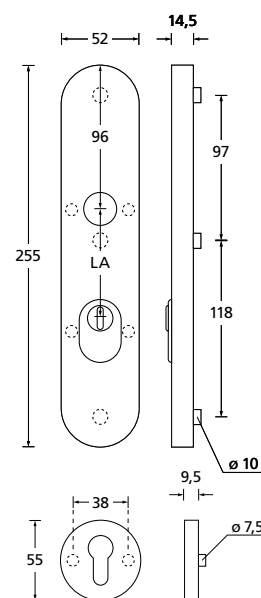

Zylinderüberstand 10 - 15 mm

Sicherheitsrosetten rund



Sicherheitsrosette mit Kernziehschutz
EDELSTAHL matt



Sicherheitsrosette
EDELSTAHL matt



Sicherheitsrosette mit Kernziehschutz
EDELSTAHL poliert



Sicherheitsrosette
EDELSTAHL poliert



Sicherheitsrosette mit Kernziehschutz
PVD Messinggelb



Sicherheitsrosette
PVD Messinggelb

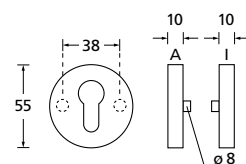
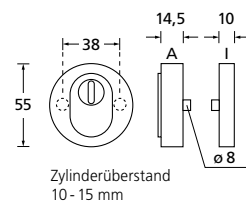

	Edelstahl matt		Edelstahl poliert		PVD Messinggelb	
	€ exkl. MwSt.		€ exkl. MwSt.		€ exkl. MwSt.	
Sicherheitsrosette PZ						
inkl. Innenrosette						
mit Kernziehschutz	27041	44,90	P27041	46,90	PVM27041	48,90
ohne Kernziehschutz	27040	36,90	P27040	38,90	PVM27040	40,90
Sicherheitsrosette RZ						
inkl. Innenrosette						
ohne Kernziehschutz	27042	36,90				



Sicherheitsrosetten Quadrat



Sicherheitsrosette mit Kernziehschutz
EDELSTAHL matt



Sicherheitsrosette
EDELSTAHL matt



Sicherheitsrosette mit Kernziehschutz
EDELSTAHL poliert



Sicherheitsrosette
EDELSTAHL poliert



Sicherheitsrosette mit Kernziehschutz
PVD Messinggelb



Sicherheitsrosette
PVD Messinggelb

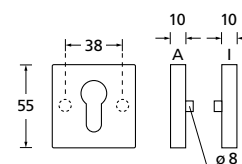
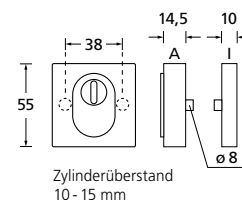

	Edelstahl matt		Edelstahl poliert		PVD Messinggelb	
Sicherheitsrosette PZ	€ exkl. MwSt.		€ exkl. MwSt.		€ exkl. MwSt.	
inkl. Innenrosette						
mit Kernziehschutz	Q27041	50,90	QP27041	52,90	QPVM27041	54,90
ohne Kernziehschutz	Q27040	42,90	QP27040	44,90	QPVM27040	46,90

Sicherheitsrosetten oval



Sicherheitsrosette mit Kernziehschutz
EDELSTAHL matt



Sicherheitsrosette
EDELSTAHL matt



Sicherheitsrosette mit Kernziehschutz
EDELSTAHL poliert



Sicherheitsrosette
EDELSTAHL poliert

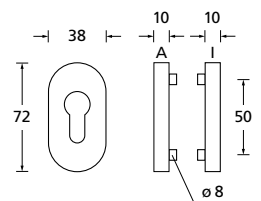
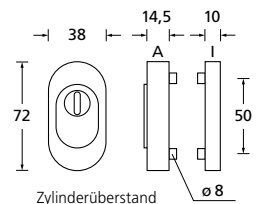

	Edelstahl matt		Edelstahl poliert	
		€ exkl. MwSt.		€ exkl. MwSt.
Sicherheitsrosette PZ				
inkl. Innenrosette				
mit Kernziehschutz	27051	52,90	P27051	54,90
ohne Kernziehschutz	27050	46,90	P27050	48,90
Sicherheitsrosette PZ				
Stück einseitig befestigt				
ohne Kernziehschutz	27150	26,90	P27150	30,90

Standard-Türstärken: 36 - 90 mm



Sicherheitsrosetten eckig



Sicherheitsrosette mit Kernziehschutz
EDELSTAHL matt



Sicherheitsrosette
EDELSTAHL matt



Sicherheitsrosette mit Kernziehschutz
EDELSTAHL poliert



Sicherheitsrosette
EDELSTAHL poliert

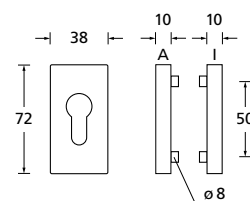
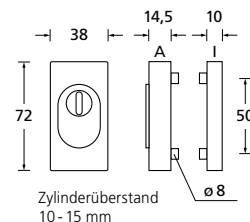

	Edelstahl matt		Edelstahl poliert	
	€ exkl. MwSt.		€ exkl. MwSt.	
Sicherheitsrosette PZ				
inkl. Innenrosette				
mit Kernziehschutz	E27051	58,90	EP27051	60,90
ohne Kernziehschutz	E27050	52,90	EP27050	54,90
Sicherheitsrosette PZ				
Stück einseitig befestigt				
ohne Kernziehschutz	E27150	30,90	EP27150	34,90

Standard-Türstärken: 36-90 mm

Einleitung	ab	2
Kombinationsmöglichkeiten	ab	18
Schnellübersicht Formen	ab	20
Privat- und Objektbau GK3	ab	27
Feuerschutzgarnituren	ab	197
Rosetten/Knöpfe/Schilder	ab	211
Office Glastürbeschläge	ab	247
Glastürbeschläge	ab	253
Fenstergriffe	ab	277
Sicherheit	ab	311

Stoßgriffe

Muschelgriffe	ab	342
Türstopper	ab	347
Türfixierer	ab	349
Hausnummern	ab	350
Buchstaben und Hinweisschilder	ab	351

Stoßgriffe SG 16 ø 32 / 25

Edelstahl matt

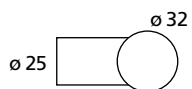

SG 16 ø 32 / 25		€ exkl. MwSt.
		Stk.
ø 32 / BA 300 / GL 400	15169	30,90
ø 32 / BA 400 / GL 600	151610	36,90



Stoßgriffe SG 16 ø 32 / 25 gekröpft Edelstahl matt

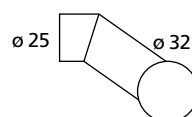

SG 16 ø 32 / 25 gekröpft		€ exkl. MwSt.
		Stk.
ø 32 / BA 300 / GL 400	25169	45,90
ø 32 / BA 350 / GL 500	251612	49,90

Stoßgriffe SG 16 ø 25 / 19

Edelstahl matt

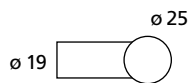

SG 16 ø 25 / 19		€ exkl. MwSt.
		Stk.
ø 25 / BA 200 / GL 400	351613	27,90
ø 25 / BA 300 / GL 400	35169	27,90
ø 25 / BA 400 / GL 600	351610	32,90



Stoßgriffe SG 16 ø 25 / 13 eckig Edelstahl matt

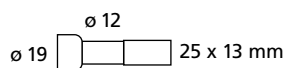

SG 16 25 / 13 eckig	€ exkl. MwSt.
25/13/BA350/GL600 15163E	Stk. 45,90

Stoßgriffe ø 32

Edelstahl matt



SG 04 32/300		€ exkl. MwSt.
		Stk.
ø 32/BA 300	15042	56,90

336



SG 05 32/300		€ exkl. MwSt.
		Stk.
ø 32/BA 300	15052	56,90



SG 07 32/300		€ exkl. MwSt.
		Stk.
ø 32/BA 300	15072	56,90

ø = Durchmesser/BA = Bohrabstand



Montage für Stoßgriffe Edelstahl matt

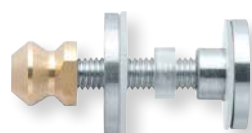

beidseitig (durchgebohrt)		€ exkl. MwSt.
für alle Türen bis 75 mm Türstärke		2 Stk.
für SG 16 Ø 32 / 25	15103	8,90
Bohrung Ø 12 mm		
für SG 16 Ø 25 / 19	15108	8,90
Bohrung Ø 12 mm		
für Stoßgriffe Ø 32	15102	8,90
Bohrung Ø 12 mm		
für SG 16 25 / 13 eckig	15112	8,90
Bohrung Ø 12 mm		

einseitig (durchgebohrt)		€ exkl. MwSt.
für alle Türen bis 75 mm Türstärke		2 Stk.
für SG 16 Ø 32 / 25	15101	8,90
Bohrung Ø 12 mm		
für SG 16 Ø 25 / 19	15109	8,90
Bohrung Ø 12 mm		
für Stoßgriffe Ø 32	15100	8,90
Bohrung Ø 12 mm		
für SG 16 25 / 13 eckig	15113	8,90
Bohrung Ø 12 mm		

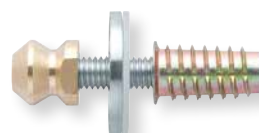
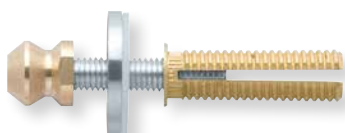

einseitig (unsichtbar)		€ exkl. MwSt.
für Hohltüren		2 Stk.
für SG 16 Ø 32 / 25	15105	8,90
Bohrung Ø 11 mm		
für SG 16 Ø 25 / 19	15110	8,90
Bohrung Ø 8 - 9 mm		
für Stoßgriffe Ø 32	15107	8,90
Bohrung Ø 11 mm		

einseitig (unsichtbar)		€ exkl. MwSt.
für Holz- und Kunststofftüren		2 Stk.
für SG 16 Ø 32 / 25	15104	8,90
Bohrung Ø 10 mm		
für SG 16 Ø 25 / 19	15111	8,90
Bohrung Ø 7,5 - 8 mm		
für Stoßgriffe Ø 32	15106	8,90
Bohrung Ø 10 mm		

Stoßgriffe nach Maß

Edelstahl matt

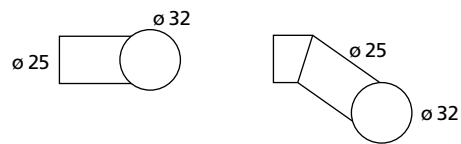
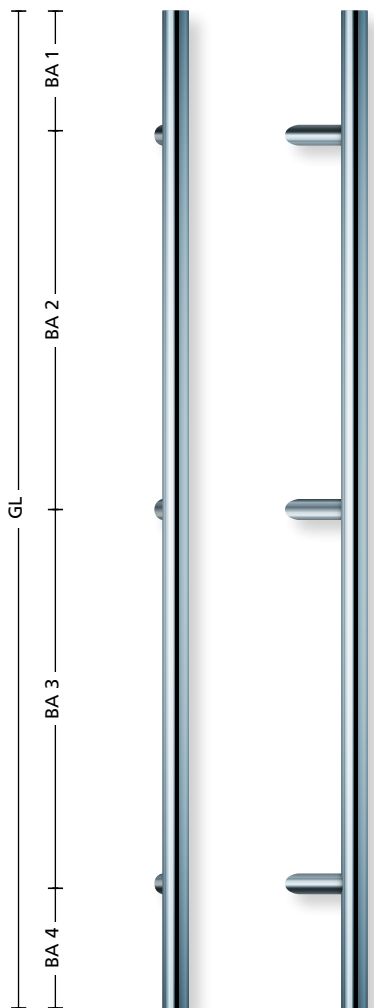

Stützen		€ exkl. MwSt.
gerade	55001	17,90
gekröpft	55002	17,90

Es werden mindestens zwei Stützen benötigt.
Der maximale Abstand zwischen den Stützen beträgt 700 mm.

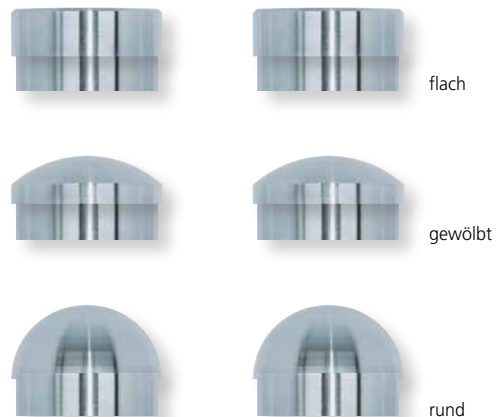

Griffstangenrohr \varnothing 32		€ exkl. MwSt.
pro 1 mm	55000	0,16

(bei Bestellung immer gewünschte Länge angeben)

Abschlusskappen		€ exkl. MwSt.
flach	55003	19,90
gewölbt	55005	19,90
rund	55004	19,90

\varnothing = Durchmesser / BA = Bohrabstand / GL = Gesamtlänge inkl. Abschlusskappen



Bestellhilfe zum Kopieren

Stoßgriff mit **2 Stützen**

Stoßgriff mit **3 Stützen**

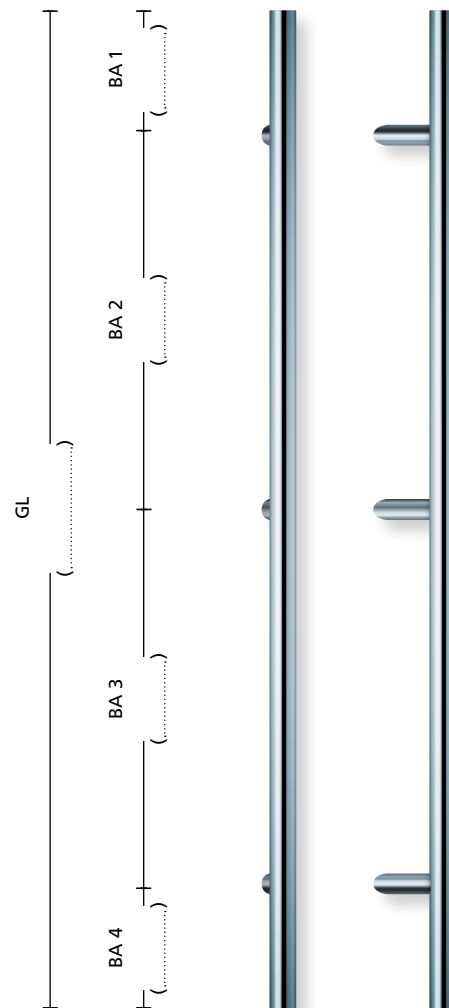
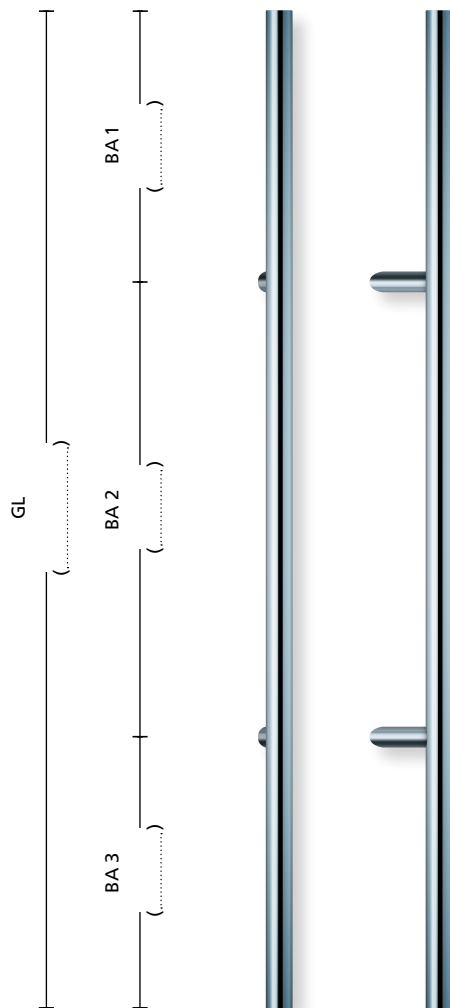

Stützen Zutreffendes bitte ankreuzen

gerade

gekröpft

Abschlusskappen Zutreffendes bitte ankreuzen

flach

gewölbt

rund

∅ = Durchmesser / BA = Bohrabstand / GL = Gesamtlänge inkl. Abschlusskappen

Einleitung	ab	2
Kombinationsmöglichkeiten	ab	18
Schnellübersicht Formen	ab	20
Privat- und Objektbau GK3	ab	27
Feuerschutzgarnituren	ab	197
Rosetten/Knöpfe/Schilder	ab	211
Office Glastürbeschläge	ab	247
Glastürbeschläge	ab	253
Fenstergriffe	ab	277
Sicherheit	ab	311
Stoßgriffe	ab	331

Muschelgriffe

Türstopper

Türfixierer

Hausnummern

Buchstaben und Hinweisschilder

Muschelgriffe

Edelstahl matt

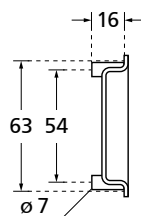
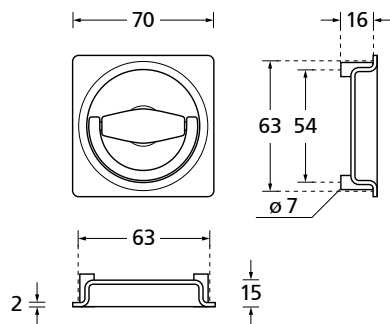
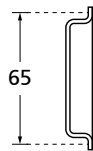
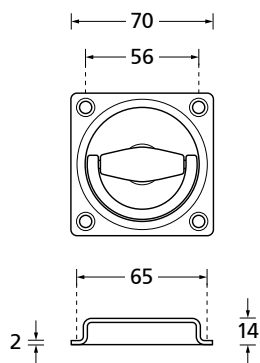

Klappingmuschel		€ exkl. MwSt.
Vierkant 7/8 mm		
Klappingmuschel	90170	33,90

Klappingmuschel		€ exkl. MwSt.
Vierkant 7/8 mm		
Klappingmuschel mit vier M4-Stütznocken	90171	33,90

342

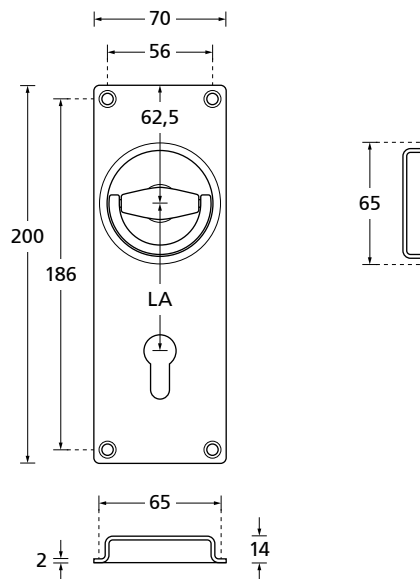

Klappingmuschel		€ exkl. MwSt.
Vierkant 8 mm		
PZ - LA 78 mm	90160	49,90
(andere Lochabstände auf Anfrage)		
Blind	90161	49,90



Muschelgriffe

Edelstahl matt

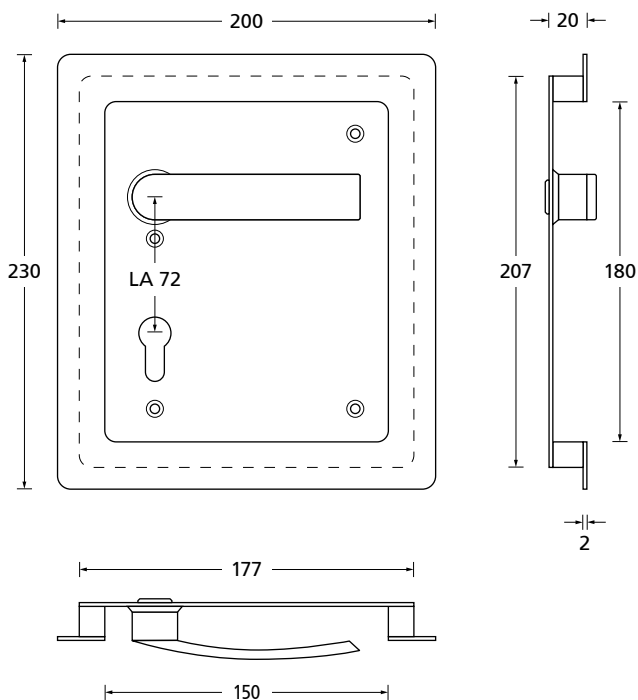

Sporthallenmuschel		€ exkl. MwSt.
Vierkant 9 mm		
PZ - LA 72 mm DIN R	90360	119,90
PZ - LA 72 mm DIN L	90361	119,90
Blind - DIN R	90460	119,90
Blind - DIN L	90461	119,90

Schiebetürmuscheln

Edelstahl

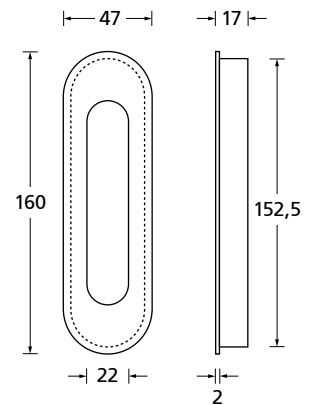
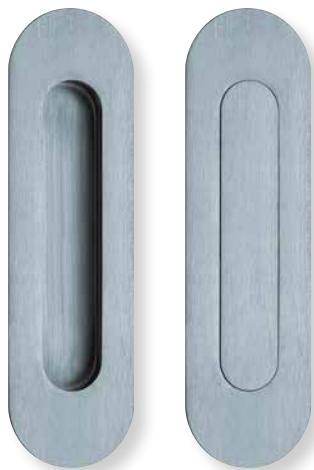

Außenmaß: 47 x 160 mm
Fräsmaß: 39,5 x 153,5 mm

Edelstahl matt

Schiebetürmuschel		€ exkl. MwSt.
oval offen	200381	23,90
oval geschlossen	20038	27,90

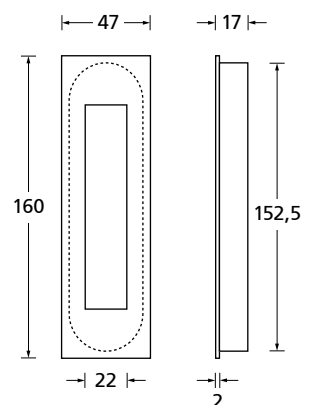

Außenmaß: 47 x 160 mm
Fräsmaß: 39,5 x 153,5 mm

Edelstahl matt

Schiebetürmuschel		€ exkl. MwSt.
rechteckig offen	200411	27,90
rechteckig geschlossen	20041	31,90

Edelstahl poliert

Schiebetürmuschel		€ exkl. MwSt.
rechteckig geschlossen	P20041	40,90

PVD Messinggelb

Schiebetürmuschel		€ exkl. MwSt.
rechteckig geschlossen	PVM20041	51,90



Schiebetürmuscheln Edelstahl

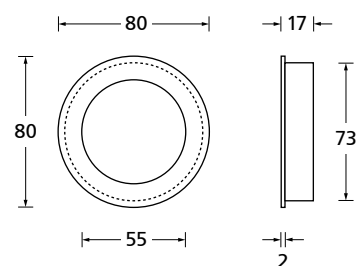

Außenmaß: \varnothing 80 mm
Fräsmaß: \varnothing 73,5 mm

Edelstahl matt

Schiebetürmuschel		€	exkl. MwSt.
rund geschlossen	20039		21,90

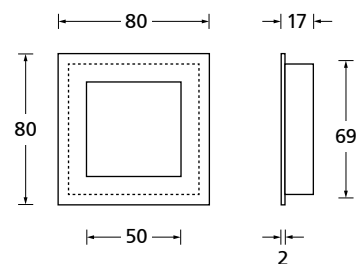
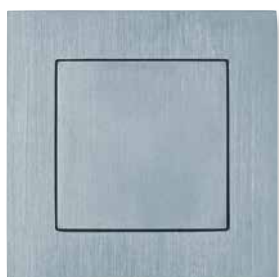

Außenmaß: 80x80 mm
Fräsmaß: 70x70 mm

Edelstahl matt

Schiebetürmuschel		€	exkl. MwSt.
quadratisch geschlossen	20040		25,90

Schiebetürmuscheln

Edelstahl

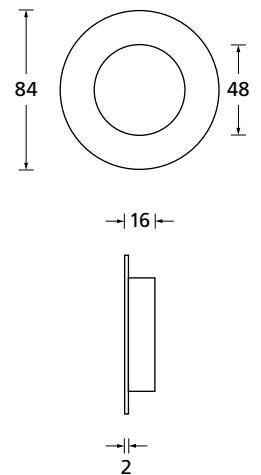

Außenmaß: ø84 mm
Fräsmaß: ø51 mm

Edelstahl matt

Schiebetürmuschel		€	exkl. MwSt.
rund	20031	17,90	
rund unsichtbare Befestigung	20034	17,90	

Edelstahl poliert

Schiebetürmuschel		€	exkl. MwSt.
rund	P20031	19,90	
rund unsichtbare Befestigung	P20034	19,90	

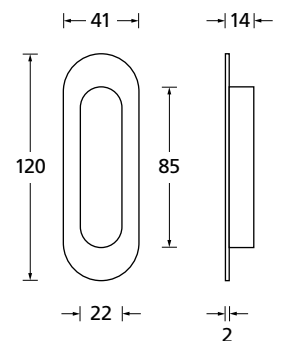
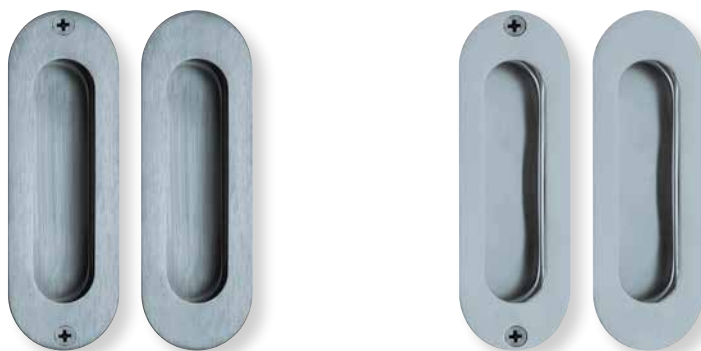

Außenmaß: 41 x 120 mm
Fräsmaß: 30 x 95 mm

Edelstahl matt

Schiebetürmuschel		€	exkl. MwSt.
oval	20030	17,90	
oval unsichtbare Befestigung	20032	17,90	

Edelstahl poliert

Schiebetürmuschel		€	exkl. MwSt.
oval	P20030	19,90	
oval unsichtbare Befestigung	P20032	19,90	



Türstopper Edelstahl matt

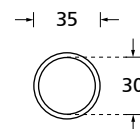
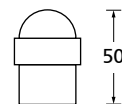

Türstopper rund TS 20 € exkl. MwSt.
H 50/ø 30 mm 20020 15,90

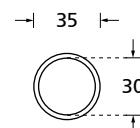
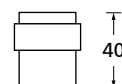

Türstopper flach TS 21 € exkl. MwSt.
H 40/ø 30 mm 20021 15,90

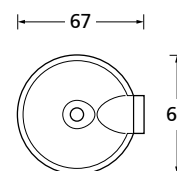
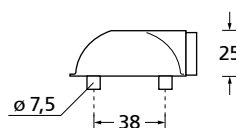

Türstopper Schildkröte TS 23 € exkl. MwSt.
H 25/L 67/B 65 mm 20023 18,90

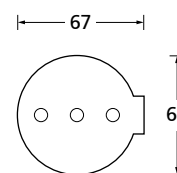
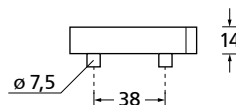

Gummi-Unterlegplatte € exkl. MwSt.
für Türstopper Schildkröte TS 23
H 14/L 67/B 65 mm 200231 3,00

Türstopper

Edelstahl matt

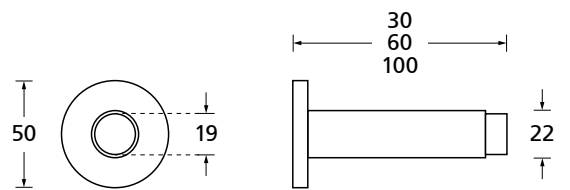

Wandtürstopper TS 22		€ exkl. MwSt.
L 100/ø 22 mm	20022	18,90
L 60/ø 22 mm	20022/60	16,90
L 30/ø 22 mm	20022/30	14,90

348

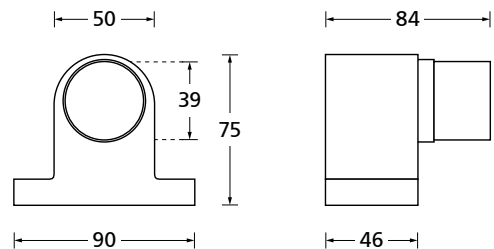

Türst. Edelstahl mit Feder TS 35		€ exkl. MwSt.
Edelstahl H 75/L 84/B 90/46 mm		
Gummi ø 39 mm	20035	30,90



Türfixierer

Edelstahl matt

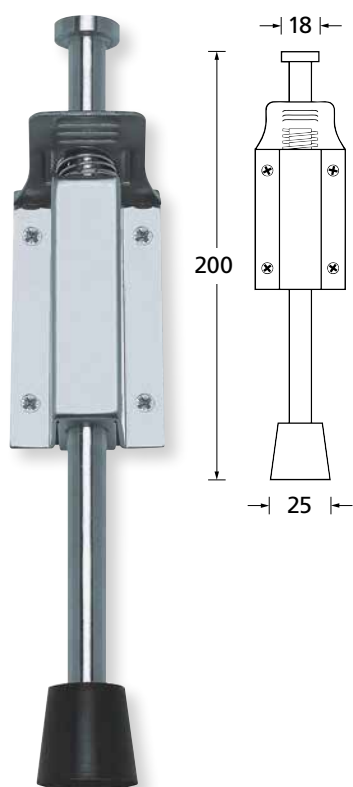

Türfixierer TF 04 € exkl. MwSt.
Hub 40 mm 20024 18,90

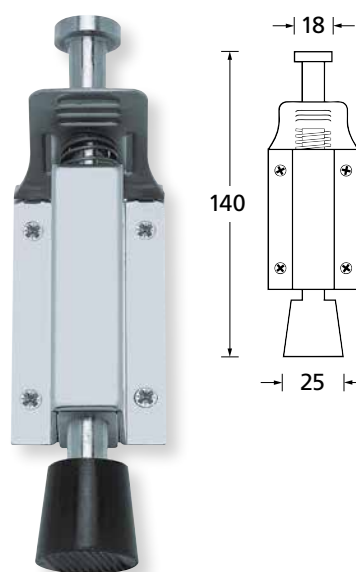

Türfixierer TF 05 € exkl. MwSt.
Hub 40 mm 20025 18,90

Hausnummern

Edelstahl matt

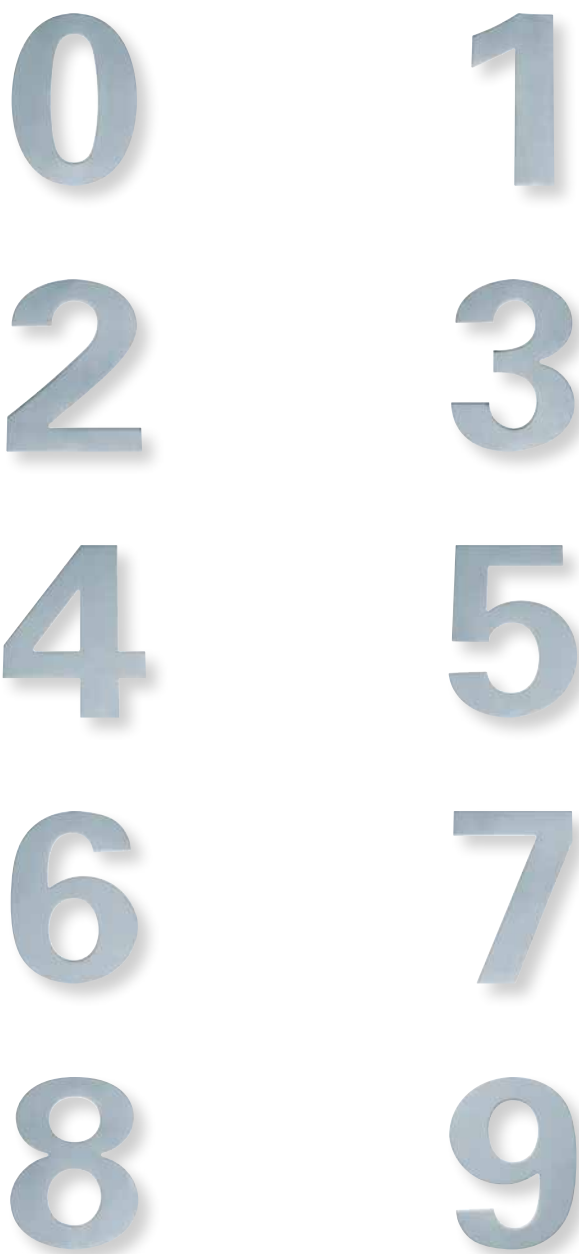

H 150 mm		€ exkl. MwSt.
Hausnummer „0“	13000	15,90
Hausnummer „1“	13001	15,90
Hausnummer „2“	13002	15,90
Hausnummer „3“	13003	15,90
Hausnummer „4“	13004	15,90
Hausnummer „5“	13005	15,90
Hausnummer „6“ / „9“	13006	15,90
Hausnummer „7“	13007	15,90
Hausnummer „8“	13008	15,90



Buchstaben und Hinweisschilder Edelstahl matt

a



b



c



d



b, d=H 150 mm / a, c=H 115 mm		€ exkl. MwSt.
Buchstabe „a“	13009	15,90
Buchstabe „b“	13010	15,90
Buchstabe „c“	13011	15,90
Buchstabe „d“	13012	15,90

ø 75 mm		€ exkl. MwSt.
Damen	20010	9,90
Herren	20011	9,90
WC	20014	9,90
Handicap	20012	9,90
Nichtraucher	20013	9,90



scoop Beschlage Vertriebs-GmbH
Kaltenbrunn 22
D-83413 Fridolfing
Fon: +49 8684 96967-0
Fax: +49 8684 96967-29
info@scoop-tec.de
www.scoop-tec.de

scoop®, Pullbloc®, Pullbloc® 3.0, Pullbloc® 4.1, Slidebloc®, Slidebloc® 3.0, Slidebloc® 4.0, Slidebloc® light und formspiele® sind eingetragene Marken der scoop Beschlage Vertriebs-GmbH. Die in diesem Katalog enthaltenen Beschreibungen und Abbildungen entsprechen dem Zeitpunkt der Drucklegung. Fur Druck- oder Satzfehler wird keine Haftung ubernommen.

Unsere Allgemeinen Geschaftsbefingungen finden Sie unter www.scoop-tec.de. Alle Rechte behalten wir uns vor.

© copyright: scoop Beschlage Vertriebs-GmbH. Mai 2021.

